

Safety Regulation Group



CAP 413

Radiotelephony Manual

Edition 20

www.caa.co.uk

Safety Regulation Group



CAP 413

Radiotelephony Manual

Edition 20

31 March 2011

© Civil Aviation Authority 2011

All rights reserved. Copies of this publication may be reproduced for personal use, or for use within a company or organisation, but may not otherwise be reproduced for publication.

To use or reference CAA publications for any other purpose, for example within training material for students, please contact the CAA at the address below for formal agreement.

ISBN 978 0 11792 527 4

First published September 1978

Second edition April 1984

Third edition August 1992

Fourth edition January 1994

Fifth edition January 1995

Sixth edition January 1996

Seventh edition December 1996

Eighth edition January 1998

Ninth edition January 1999

Tenth edition January 2000

Eleventh edition January 2001

Twelfth edition 5 February 2002 (corrected 7 February 2002)

Thirteenth edition 1 October 2002

Fourteenth edition 1 September 2003

Fifteenth edition 1 September 2004

Sixteenth edition 1 May 2006

Seventeenth edition 21 July 2008

Eighteenth edition 19 February 2009 (effective date 12 March 2009)

Nineteenth edition 15 December 2009

Twentieth edition 31 March 2011

Enquiries regarding the content of this publication should be addressed to:

Air Traffic Standards Division, Safety Regulation Group, Civil Aviation Authority, Aviation House, Gatwick Airport South, West Sussex, RH6 0YR

The latest version of this document is available in electronic format at www.caa.co.uk/publications, where you may also register for e-mail notification of amendments.

Published by TSO (The Stationery Office) on behalf of the UK Civil Aviation Authority.

Printed copy available from:

TSO, PO Box 29, Norwich NR3 1GN

Telephone orders/General enquiries: 0844 477 7300

Fax orders: 0870 600 5533

www.tsoshop.co.uk

E-mail: caa@tso.co.uk

Textphone: 0870 240 3701

List of Effective Pages

Chapter	Page	Date	Chapter	Page	Date
	iii	31 March 2011	Chapter 2	10	31 March 2011
	iv	31 March 2011	Chapter 2	11	31 March 2011
	v	31 March 2011	Chapter 2	12	31 March 2011
Contents	1	31 March 2011	Chapter 2	13	31 March 2011
Contents	2	31 March 2011	Chapter 2	14	31 March 2011
Contents	3	31 March 2011	Chapter 2	15	31 March 2011
Contents	4	31 March 2011	Chapter 2	16	31 March 2011
Contents	5	31 March 2011	Chapter 2	17	31 March 2011
Contents	6	31 March 2011	Chapter 2	18	31 March 2011
Contents	7	31 March 2011	Chapter 2	19	31 March 2011
Revision History	1	31 March 2011	Chapter 2	20	31 March 2011
Revision History	2	31 March 2011	Chapter 2	21	31 March 2011
Revision History	3	31 March 2011	Chapter 2	22	31 March 2011
Revision History	4	31 March 2011	Chapter 3	1	31 March 2011
Revision History	5	31 March 2011	Chapter 3	2	31 March 2011
Revision History	6	31 March 2011	Chapter 3	3	31 March 2011
Revision History	7	31 March 2011	Chapter 3	4	31 March 2011
Revision History	8	31 March 2011	Chapter 3	5	31 March 2011
Revision History	9	31 March 2011	Chapter 3	6	31 March 2011
Revision History	10	31 March 2011	Chapter 3	7	31 March 2011
Revision History	11	31 March 2011	Chapter 3	8	31 March 2011
Revision History	12	31 March 2011	Chapter 3	9	31 March 2011
Revision History	13	31 March 2011	Chapter 3	10	31 March 2011
Foreword	1	31 March 2011	Chapter 3	11	31 March 2011
Foreword	2	31 March 2011	Chapter 4	1	31 March 2011
Chapter 1	1	31 March 2011	Chapter 4	2	31 March 2011
Chapter 1	2	31 March 2011	Chapter 4	3	31 March 2011
Chapter 1	3	31 March 2011	Chapter 4	4	31 March 2011
Chapter 1	4	31 March 2011	Chapter 4	5	31 March 2011
Chapter 1	5	31 March 2011	Chapter 4	6	31 March 2011
Chapter 1	6	31 March 2011	Chapter 4	7	31 March 2011
Chapter 1	7	31 March 2011	Chapter 4	8	31 March 2011
Chapter 1	8	31 March 2011	Chapter 4	9	31 March 2011
Chapter 1	9	31 March 2011	Chapter 4	10	31 March 2011
Chapter 1	10	31 March 2011	Chapter 4	11	31 March 2011
Chapter 2	1	31 March 2011	Chapter 4	12	31 March 2011
Chapter 2	2	31 March 2011	Chapter 4	13	31 March 2011
Chapter 2	3	31 March 2011	Chapter 4	14	31 March 2011
Chapter 2	4	31 March 2011	Chapter 4	15	31 March 2011
Chapter 2	5	31 March 2011	Chapter 4	16	31 March 2011
Chapter 2	6	31 March 2011	Chapter 4	17	31 March 2011
Chapter 2	7	31 March 2011	Chapter 4	18	31 March 2011
Chapter 2	8	31 March 2011	Chapter 4	19	31 March 2011
Chapter 2	9	31 March 2011	Chapter 4	20	31 March 2011

Chapter	Page	Date	Chapter	Page	Date
Chapter 4	21	31 March 2011	Chapter 6	10	31 March 2011
Chapter 4	22	31 March 2011	Chapter 6	11	31 March 2011
Chapter 4	23	31 March 2011	Chapter 6	12	31 March 2011
Chapter 4	24	31 March 2011	Chapter 6	13	31 March 2011
Chapter 4	25	31 March 2011	Chapter 6	14	31 March 2011
Chapter 4	26	31 March 2011	Chapter 6	15	31 March 2011
Chapter 4	27	31 March 2011	Chapter 6	16	31 March 2011
Chapter 4	28	31 March 2011	Chapter 6	17	31 March 2011
Chapter 4	29	31 March 2011	Chapter 6	18	31 March 2011
Chapter 4	30	31 March 2011	Chapter 6	19	31 March 2011
Chapter 4	31	31 March 2011	Chapter 6	20	31 March 2011
Chapter 4	32	31 March 2011	Chapter 6	21	31 March 2011
Chapter 4	33	31 March 2011	Chapter 6	22	31 March 2011
Chapter 4	34	31 March 2011	Chapter 6	23	31 March 2011
Chapter 4	35	31 March 2011	Chapter 6	24	31 March 2011
Chapter 4	36	31 March 2011	Chapter 6	25	31 March 2011
Chapter 4	37	31 March 2011	Chapter 6	26	31 March 2011
Chapter 4	38	31 March 2011	Chapter 6	27	31 March 2011
Chapter 4	39	31 March 2011	Chapter 6	28	31 March 2011
Chapter 4	40	31 March 2011	Chapter 6	29	31 March 2011
Chapter 4	41	31 March 2011	Chapter 6	30	31 March 2011
Chapter 4	42	31 March 2011	Chapter 7	1	31 March 2011
Chapter 4	43	31 March 2011	Chapter 7	2	31 March 2011
Chapter 4	44	31 March 2011	Chapter 7	3	31 March 2011
Chapter 4	45	31 March 2011	Chapter 7	4	31 March 2011
Chapter 4	46	31 March 2011	Chapter 7	5	31 March 2011
Chapter 5	1	31 March 2011	Chapter 8	1	31 March 2011
Chapter 5	2	31 March 2011	Chapter 8	2	31 March 2011
Chapter 5	3	31 March 2011	Chapter 8	3	31 March 2011
Chapter 5	4	31 March 2011	Chapter 8	4	31 March 2011
Chapter 5	5	31 March 2011	Chapter 8	5	31 March 2011
Chapter 5	6	31 March 2011	Chapter 8	6	31 March 2011
Chapter 5	7	31 March 2011	Chapter 9	1	31 March 2011
Chapter 5	8	31 March 2011	Chapter 9	2	31 March 2011
Chapter 5	9	31 March 2011	Chapter 9	3	31 March 2011
Chapter 5	10	31 March 2011	Chapter 9	4	31 March 2011
Chapter 5	11	31 March 2011	Chapter 9	5	31 March 2011
Chapter 6	1	31 March 2011	Chapter 9	6	31 March 2011
Chapter 6	2	31 March 2011	Chapter 9	7	31 March 2011
Chapter 6	3	31 March 2011	Chapter 10	1	31 March 2011
Chapter 6	4	31 March 2011	Chapter 10	2	31 March 2011
Chapter 6	5	31 March 2011	Chapter 10	3	31 March 2011
Chapter 6	6	31 March 2011	Chapter 10	4	31 March 2011
Chapter 6	7	31 March 2011	Chapter 10	5	31 March 2011
Chapter 6	8	31 March 2011	Chapter 10	6	31 March 2011
Chapter 6	9	31 March 2011	Chapter 10	7	31 March 2011

Chapter	Page	Date	Chapter	Page	Date
Chapter 10	8	31 March 2011	Chapter 11	27	31 March 2011
Chapter 10	9	31 March 2011	Chapter 11	28	31 March 2011
Chapter 10	10	31 March 2011	Chapter 11	29	31 March 2011
Chapter 10	11	31 March 2011	Chapter 11	30	31 March 2011
Chapter 10	12	31 March 2011	Chapter 11	31	31 March 2011
Chapter 10	13	31 March 2011	Chapter 11	32	31 March 2011
Chapter 10	14	31 March 2011	Chapter 11	33	31 March 2011
Chapter 10	15	31 March 2011	Chapter 11	34	31 March 2011
Chapter 10	16	31 March 2011	Chapter 11	35	31 March 2011
Chapter 10	17	31 March 2011	Chapter 11	36	31 March 2011
Chapter 10	18	31 March 2011	Appendix 1	1	31 March 2011
Chapter 10	19	31 March 2011	Appendix 1	2	31 March 2011
Chapter 10	20	31 March 2011	Appendix 1	3	31 March 2011
Chapter 10	21	31 March 2011	Appendix 1	4	31 March 2011
Chapter 10	22	31 March 2011	Appendix 1	5	31 March 2011
Chapter 10	23	31 March 2011	Appendix 2	1	31 March 2011
Chapter 10	24	31 March 2011	Appendix 2	2	31 March 2011
Chapter 10	25	31 March 2011	Appendix 2	3	31 March 2011
Chapter 10	26	31 March 2011	Appendix 2	4	31 March 2011
Chapter 10	27	31 March 2011	Bibliography	1	31 March 2011
Chapter 11	1	31 March 2011	Index	1	31 March 2011
Chapter 11	2	31 March 2011	Index	2	31 March 2011
Chapter 11	3	31 March 2011	Index	3	31 March 2011
Chapter 11	4	31 March 2011	Index	4	31 March 2011
Chapter 11	5	31 March 2011	Index	5	31 March 2011
Chapter 11	6	31 March 2011	Index	6	31 March 2011
Chapter 11	7	31 March 2011	Index	7	31 March 2011
Chapter 11	8	31 March 2011	Index	8	31 March 2011
Chapter 11	9	31 March 2011	Index	9	31 March 2011
Chapter 11	10	31 March 2011			
Chapter 11	11	31 March 2011			
Chapter 11	12	31 March 2011			
Chapter 11	13	31 March 2011			
Chapter 11	14	31 March 2011			
Chapter 11	15	31 March 2011			
Chapter 11	16	31 March 2011			
Chapter 11	17	31 March 2011			
Chapter 11	18	31 March 2011			
Chapter 11	19	31 March 2011			
Chapter 11	20	31 March 2011			
Chapter 11	21	31 March 2011			
Chapter 11	22	31 March 2011			
Chapter 11	23	31 March 2011			
Chapter 11	24	31 March 2011			
Chapter 11	25	31 March 2011			
Chapter 11	26	31 March 2011			

INTENTIONALLY LEFT BLANK

Contents

	List of Effective Pages	iii
	Revision History	1
	Foreword	1
	Document Description	1
	Document Purpose	1
	Document Applicability	1
	Document Source	1
	Document Format	1
	Document Revisions	2
	Document Availability	2
	Document Comments and Queries	2
Chapter 1	Glossary	
	Terms	1
	Definitions	1
	Abbreviations	5
Chapter 2	Radiotelephony	
	General Procedures	1
	Introduction	1
	Transmitting Technique	1
	Transmission of Letters	2
	Transmission of Numbers	3
	Transmission of Time	4
	Standard Words and Phrases	5
	Callsigns for Aeronautical Stations	7
	Callsigns for Aircraft	8
	Military Aircraft Callsigns	9
	Continuation of Communications	11
	Corrections and Repetitions	13
	Acknowledgement of Receipt	13
	Transfer of Communications	13
	Clearance Issue and Read Back Requirements	14
	Withholding Clearances	17
	Simultaneous Transmissions	18
	Complying with Clearances and Instructions	18

	Communication Failure	19
	Test Transmissions	20
	Pilot Complaints Concerning Aeronautical Telecommunications	21
	Air Traffic Service Complaints Concerning Aircraft Communications	21
	Hours of Service and Communications Watch	21
	Record of Communications	22
	Categories of Message	22
Chapter 3	General Phraseology	
	General	1
	Introduction	1
	Level Reporting	1
	Speed Control	5
	Initial Call – IFR flights	6
	Initial Call – VFR Flight	7
	Reply to 'Pass Your Message'	7
	Position Reporting	8
	Flight Plans	9
	Low Visibility Procedures	10
	Delays	10
Chapter 4	Aerodrome Phraseology	
	Aerodrome Control Service Phraseology	1
	Introduction	1
	Type of Service	1
	Departure Information and Engine Starting Procedures	1
	Pushback and Powerback	2
	Taxi Instructions	2
	Pre-Departure Manoeuvring	5
	Take-Off Clearance	6
	Aerodrome Traffic Circuit	10
	Final Approach and Landing	13
	Missed Approach	15
	Runway Vacating and Communicating After Landing	16
	Essential Aerodrome Information	16
	Arrestor Systems at Military Aerodromes	17
	Aerodrome Flight Information Service Phraseology	18
	Introduction	18
	Type of Service	18
	AFIS Phraseology for Ground Movement, Take-off, Landing and Transit	19

Aerodrome Phraseology for Helicopters	23
Introduction	23
Helicopter Callsigns	23
Helicopter Phraseology for Taxiing	23
Helicopter Phraseology for Take-Off and Landing (ATC only)	24
Helicopter Hover Phraseology Examples (ATC and AFIS only)	24
Helicopter Taxiing Phraseology Examples (ATC and AFIS only)	25
Helicopter Take-Off and Landing Phraseology Examples (ATC only)	25
Aerodrome Phraseology for Vehicles (ATC and AFIS only)	27
Introduction	27
Movement Instructions	27
To Cross a Runway	29
Vehicles Towing Aircraft	30
Low Visibility Procedures	31
Messages regarding Safety of an Aircraft	31
Messages regarding Wildlife	31
Driver unsure of Position	31
Broken-Down Vehicle	31
Radio Failure	31
Aerodrome Air/Ground Communication Service Phraseology	32
Introduction	32
Type of Service	32
Air/Ground Station Identification	32
Phraseology and Examples	32
Offshore Communication Service	36
Radiotelephony Reports at Unattended Aerodromes	39
Introduction	39
Additional Procedures for the Use of SAFETYCOM	39
Unattended Aerodrome Phraseology Examples	40
Aerodrome Information	42
Meteorological Conditions	42
Voice Weather Broadcast (VOLMET) UK	42
Runway Visual Range (RVR)/Visibility/Absolute Minimum	43
Runway Surface Conditions	45
Automatic Terminal Information Service (ATIS) UK	46
Chapter 5	
Radar Phraseology	
General	1
Introduction	1
Radar Identification of Aircraft	1
Secondary Surveillance Radar Phraseology	2

	ATS Surveillance Service	4
	Radar Vectoring	4
	Traffic Information and Avoiding Action Phraseology	6
	ACAS/TCAS Phraseology	7
	Communications and Loss of Communications	8
	Essential Traffic Information	8
	Danger Area Crossing Service/Danger Area Activity Information Service	9
Chapter 6	Approach Phraseology	
	Approach Control Service Phraseology	1
	IFR Departures	1
	VFR Departures	2
	IFR Arrivals	3
	VFR Arrivals	7
	Special VFR Flights	8
	Vectoring to Final Approach	9
	Direction Finding (DF)	12
	VDF Procedure	13
	NDB(L) and VOR Procedures	17
	Area Navigation Global Navigation Satellite System RNAV (GNSS) Phraseology	20
	Surveillance Radar Approach (SRA)	21
	Landing Altimeter Setting (QNE)	24
	PAR Approach	24
	Clearance to enter Control Zones (CTR)	24
	Aerodrome Traffic Zone (ATZ) associated with another Aerodrome	25
	Lower Airspace Radar Service (LARS)	26
	Air Traffic Services Outside Controlled Airspace (ATSOCAS)	26
Chapter 7	Area Phraseology	
	Area Control Service Phraseology	1
	General	1
	Position Reporting	1
	Flights Joining Airways	2
	Flights Leaving Airways	2
	Flights Crossing Airways	3
	Flights Holding En-Route	3
	Reduced Vertical Separation Minimum (RVSM) Phraseology	4

Chapter 8	Emergency Phraseology	
	Distress and Urgency Communication Procedures	1
	Introduction	1
	States of Emergency	1
	UHF and VHF Emergency Service	1
	UHF and VHF Emergency Service – General Procedures	2
	Emergency Message	3
	Ejection from Aircraft	4
	Speechless Code	4
	Radio Procedures – Practice Emergencies	4
	Training Fix	5
	Relayed Emergency Message	5
	Imposition of Silence	5
	Emergency Descent	6
	Termination of Distress Communications and of RTF Silence	6
Chapter 9	Miscellaneous Phraseology	
	Other Communications	1
	Wake Turbulence	1
	Wind Shear	1
	AIRPROX Reporting	2
	Oil Pollution Reporting	2
	Interceptions by Military Aircraft	3
	Aircraft Operating Agency Messages	3
	Use of ATS Frequencies for Aircraft Operating Agency Messages	4
	8.33 kHz Phraseology	4
	Operations by aircraft deploying brake chutes	5
	Mareva Injunctions	6
	CPDLC Failure	7
	Aerodrome Emergency Services	7
Chapter 10	Military Specific Phraseology	
	Military Specific Phraseology	1
	Military Variances to Chapter 2	1
	Transmission of UHF Channels	1
	Transmission of Time	1
	Standard Words and Phrases	1
	Communications	2
	RT Phraseology When Using SSR	2
	Military Specific Procedures (Control of Aircraft)	2
	NATO Standard Visual Circuit Procedures	2

NATO Studs and Common VHF Frequencies	2
Weather and Aerodrome Information	3
Cancellation of Take-Off	4
Phraseology for Joining the Visual Circuit/Pattern	4
Landing Gear Position	5
Arrestor System Procedures and Phraseology	5
Phraseology for Fixed-Wing VTOL Operations	8
Emergency Messages	8
Flameout/Engine Failure – Aerodrome Phraseology	8
PAR Phraseology	9
PAR Azimuth Only/SRA Phraseology	11
ILS Phraseology	12
Descent to Low Level	14
Jamming phraseology	14
Speechless Procedures	14
Military Missed Approach	16
Suspension of RT Procedures	17
Formations in Trail	17
Contact Lost	17
Freecall and Continue With	17
Aerobatics and General Handling	18
Passing the Number of Persons on Board (POB)	18
Clearances with an Occupied Runway	18
Formation Clearances	19
TACAN Specific Phraseology	19
Radar PFL	20
Controlled Descent through Cloud (QGH)	20
Flameout Spiral Descent	23
No Compass/No Gyro	25
Supersonic Flight	25
Military Aerodrome Traffic Zones (MATZ) and Penetration Services	26
Military Safety Broadcast – Sécurité	27

Chapter 11 Phraseology Examples

Examples of Types of Flights	1
Introduction	1
An IFR Flight	2
A VFR/IFR Flight	17
Flight in the Military Visual Circuit	24
Flight Receiving Lower Airspace Radar Service (LARS) and Danger Area Crossing Service (DACCS)	28

Callsign Prefix – 'STUDENT'	30
Flight Receiving Avoiding Action	31
Flight Receiving En-Route Basic Service	32
Flight Transmitting a Practice Pan	33
Arrival Flight (Aerodrome FIS)	35

Appendix 1 UK Differences to ICAO Radiotelephony Procedures

Appendix 2 UK Civil/Military Radiotelephony Differences

Bibliography

Index

INTENTIONALLY LEFT BLANK

Revision History

1 Revisions included in Edition 16

1.1 In addition to editorial changes and minor corrections, Edition 16 comprises:

Radiotelephony	Chapter 2 Paragraph 1.14	Meaning of 'when ready', 'after passing', 'now' and 'immediately' in relation to clearances and instructions from an ATS unit.
	Chapter 2 Paragraph 1.4.4	Change to indication of VHF channels in line with ICAO's change to Annex 10.
General Phraseology	Chapter 3 Paragraph 1.2.4	Level reporting when in receipt of a Radar Control service.
	Chapter 3, Paragraph 1.3	Information required on the initial call for IFR flights on instrument departures.
	Chapter 3, Paragraph 1.4	Information required on the initial call for VFR departures.
	Chapter 3, Paragraph 1.5	Reply to an instruction to 'Pass Your Message'.
Aerodrome Phraseology	Chapter 4, Paragraph 1.9.3 c)	Runway occupancy - ensuring preceding landing aircraft does not require to backtrack
	Chapter 4, Paragraph 2.3.3	Additional examples of FISO/Pilot RTF exchanges at the holding point.
	Chapter 4, Figure 1	Standard overhead join procedure diagram updated.
Approach Phraseology	Chapter 6, Paragraph 1.1.2	Information required on the initial call for IFR flights on instrument departures.
	Chapter 6, Figure 1	Radar vectors to ILS approach diagram updated.
Miscellaneous Phraseology	Chapter 9, Paragraph 1.8	Phraseology to be used during operations with aircraft using brake chutes.

Appendix 1

Table 1

Appendix 1 (Table of UK Differences to ICAO Radiotelephony Procedures)
Cleared for ILS Approach is not used in the UK in order to prevent aircraft descending before establishing on the localiser. Instead pilots are asked to report established on the localiser; when established, descent instructions are given.

Removal of difference concerning Holding Point and Holding Position. ICAO has now adopted the phraseology 'Holding Point' to remove potential for confusion with an instruction to 'Hold Position'.

2 Revisions included in Edition 17

2.1 In addition to editorial changes and minor corrections, Edition 17 comprises:

Callsigns used in examples	Throughout Document Global Change	Removes 'Fastair' (to prevent confusion with new 'Fastjet/Fastprop' prefix being introduced) and replaces '345' with '347' to conform with ICAO Doc 8585 and AIC 107/2000 guidance regarding use of potentially confusing numbers in callsigns).
Foreword	Page 1	Change FIS to AFIS.
Abbreviations	Chapter 1 Page 2	Delete FIS.
Abbreviations	Chapter 1 Page 6	Delete FIS.
Callsigns	Chapter 2 Page 7	Amend FISOs to read AFISOs.
Callsigns For Aircraft	Chapter 2 Page 8	Adds content to initial call (removes impression that callsign alone is an acceptable form of initial call).
Callsigns For Aircraft	Chapter 2 Page 8	Introduces 'STUDENT' callsign prefix and FASTJET/FASTPROP prefixes.
Simultaneous transmissions	Chapter 2 Page 14	Inserts (as 1.14) additional text dealing with 'blocked' transmissions.
Level Reporting	Chapter 3 Page 3	Introduces text regarding need to restrict rate of climb/descent to a maximum of 8000 ft/min when instructed to 'expedite'.
Initial Call – IFR Flights	Chapter 3 Page 4 and 5	Text dealing with level reporting amended to improve clarity.
Initial Call – VFR Flights	Chapter 3 Page 5	Example amended from 'request joining instructions' to 'request join'. Further example added to reflect a request for zone transit.

Position Reporting	Chapter 3 Page 7	Adds a GA example.
Designated positions in the Traffic circuit	Chapter 3 Page 8	Moves diagram and notes to more appropriate place in document (Chapter 4 Page 8).
Aerodrome Phraseology	Chapter 4 Page 1	Amend FISOs to read AFISOs.
Taxi Instructions	Chapter 4 Page 2	Add requirement for taxi clearances wherever possible to be noted down by pilots and removes 'instructions' from example.
Taxi Instructions	Chapter 4 Page 2 and 3	Corrects example to reflect use of full aircraft callsign in ATC response to first call.
Taxi Instructions	Chapter 4 Page 4	Inserts additional text dealing with optional insertion of 'hold short of' with taxi instructions which will involve a runway crossing.
Holding point designator in line-up instruction	Chapter 4 Page 5	Makes provision for holding point designator to be included in any other line-up instruction when considered necessary.
Take-Off Clearance	Chapter 4 Page 6 and Chapter 4 Page 7	Clarifies requirement to place the runway designator before the clearance.
Aerodrome Traffic Circuit	Chapter 4 Page 8	Moves diagram and notes to more appropriate place in document.
Aerodrome Traffic Circuit	Chapter 4 Page 9	Amends VFR arrival example to include earlier 'request join' call and response.
Final Approach & Landing	Chapter 4 Page 11	Correction of typographical errors.
SAFETYCOM	Chapter 4 Page 34	Removes anomaly regarding use of SAFETYCOM for 'overhead' call at 2000 ft above aerodrome.
Aerodrome FIS Phraseology	Chapter 4 Page 15	Amendments which anticipate the introduction of revised ATSOCAS.
Aerodrome FIS Phraseology	Chapter 4 Page 16	Amendments which anticipate the introduction of revised ATSOCAS.
Aerodrome FIS Phraseology	Chapter 4 Page 17	Amendments which anticipate the introduction of revised ATSOCAS.
Aerodrome FIS Phraseology	Chapter 4 Page 18	Amendments which anticipate the introduction of revised ATSOCAS.
Aerodrome FIS Phraseology	Chapter 4 Page 24	Amendments which anticipate the introduction of revised ATSOCAS.

Aerodrome AGCS Phraseology	Chapter 4 Page 27	Amendments which anticipate the introduction of revised ATSOCAS.
Aerodrome AGCS Phraseology	Chapter 4 Page 28	Amendments which anticipate the introduction of revised ATSOCAS.
Confirm (level)	Chapter 5 Page 3	Removes explanatory text associated with the 200 ft tolerance used by controllers during Mode C checks. Change made to prevent inappropriate interpretation by pilots.
Traffic Information	Chapter 5 Page 5	Editorial change to improve clarity.
Avoiding action example	Chapter 5 Page 6	Includes example of avoiding action in the vertical plane and introduces term 'unverified'.
ACAS/TCAS Phraseology	Chapter 5 Page 6	Amends TCAS Phraseology to comply with change to ICAO SARPs (effective 22 Nov 07).
DACS/DAAIS	Chapter 5 Page 8	Amendments which anticipate the introduction of revised ATSOCAS.
IFR Departures	Chapter 6 Page 1	Introduces phraseology for requesting change to departure speed due to aircraft configuration.
IFR Arrivals	Chapter 6 Page 3	Removes QFE from examples.
IFR Arrivals	Chapter 6 Page 4	Removes QFE from examples.
IFR Arrivals	Chapter 6 Page 5	Removes QFE from examples.
VFR Arrivals	Chapter 6 Page 6	Amends example to include 'request join'.
Special VFR Flights	Chapter 6 Page 7	Corrects erroneous reference to 1500 ft rule (following legislative change).
Vectoring To Final approach	Chapter 6 Page 9	Change in ILS phraseology.
Vectoring To Final approach	Chapter 6 Page 10	Change in ILS phraseology.
Vectoring To Final approach	Chapter 6 Page 13	Changes pressure setting used in the example from QFE to QNH.
Vectoring To Final approach	Chapter 6 Page 14	Changes pressure setting used in the example from QFE to QNH.

Vectoring To Final approach	Chapter 6 Page 16	Changes pressure setting used in the example from QFE to QNH and removes sentence relating to normal use of QFE.
RNAV (GNSS) Phraseology	Chapter 6 Page 17	Adds new phraseology section dealing with RNAV GNSS phraseology.
Surveillance Radar Approach	Chapter 6 Page 19	Changes 'wheels' to 'gear' and amends paragraph dealing with altimeter settings to reflect need for pilot to request QFE.
Surveillance Radar Approach	Chapter 6 Page 20	Reflects need to include Altitude and OCA when procedure is being conducted with reference to QNH.
LARS	Chapter 6 Page 26 and 27	Deletions which anticipate the introduction of revised ATSOCAS.
MAYDAY and PAN callsign prefix	Chapter 8 Page 3	Permits 'MAYDAY' and 'PAN' to be used as a callsign prefix subsequent to the initial distress/urgency message at the discretion of pilots and controllers.
Emergency Message	Chapter 8 Page 3	Removes reference to use of obsolete military prefix 'TYRO' and introduces use of callsign prefix 'STUDENT' with emergency message.
Limitations	Chapter 9 Page 3	Amendments which anticipate the introduction of revised ATSOCAS.
Brake chutes	Chapter 9 Page 5	Amendments which anticipate the introduction of revised ATSOCAS.
VFR-FIS Request	Chapter 10 Page 20	Amendments which anticipate the introduction of revised ATSOCAS.
Phraseology Examples	Chapter 10 Page 32	Includes examples of the use of the callsign prefix 'STUDENT'.
Phraseology Examples	Chapter 10 Page 37	Amends example of VFR arrival to include 'request join'.
Joining Information	Chapter 10 Page 38	Amendments which anticipate the introduction of revised ATSOCAS.
UK Differences to ICAO	Appendix 1 Page 1	Delete 5 th row of table dealing with 'Go Ahead'. Replace with text dealing with 'PAN PAN MEDICAL'.
UK Differences to ICAO	Appendix 1 Page 2	Insert new row dealing with aircraft callsigns.
UK Differences to ICAO RTF Procedures	Appendix 1 Page 2	Updates wording relating to UK ILS phraseology differences.

3 Revisions included in Edition 18

(Published date 19 February 2009 effective date 12 March 2009)

3.1 In addition to editorial changes and minor corrections, Edition 18 comprises:

Names of Air Traffic Services outside Controlled Airspace (ATSOCAS) used in examples	Throughout Document Global Change	Substitutes names of ATSOCCAS introduced in the UK from 12 March 2009 as detailed in CAP 774 (UK Flight Information Services).
Definitions	Chapter 1 Page 1 to 5	Aligns definitions with those used in ICAO Annexes and Documents, the Air Navigation Order, and Rules of the Air Regulations as appropriate.
Callsigns for Aircraft	Chapter 2 Page 8	Introduction of phraseology 'wake turbulence' instead of 'vortex wake' to comply with ICAO Doc 4444.
Clearance Issue and Read Back Requirements	Chapter 2 Page 13	Introduces term 'ATS surveillance service' as defined in ICAO Doc 4444.
Flight Plans	Chapter 3 Page 8	Introduces phraseology for activation of filed flight plan.
Flight Plans	Chapter 3 Page 8	Minor change to phraseology for cancellation of an IFR flight to conform with ICAO Doc 4444.
Taxi Instructions	Chapter 4 Page 2	Makes provision for POB to be included in request for taxi where a flight plan is not required and has not been filed.
Designated Positions in the Traffic Circuit	Chapter 4 Page 9	Clarification of requirement to comply with specific aerodrome joining procedures as published in the UK AIP.
Movement Instructions	Chapter 4 Page 24	Clarification of content of initial call from a vehicle driver.
Movement Instructions	Chapter 4 Page 25	Additional example illustrating use of 'hold position'.
Movement Instructions	Chapter 4 Page 25	Additional example illustrating use of 'hold short'.
Movement Instructions	Chapter 4 Page 25	Additional examples of cautionary information and instructions to 'report position'.
To Cross a Runway	Chapter 4 Page 26	Expanded example of clearance to cross a runway and addition of alternative instructions.
To Cross a Runway	Chapter 4 Page 26	Additional example of phraseology for vehicle entering runway to undertake a specialist task.

Vehicles Towing Aircraft	Chapter 4 Page 27	Additional example of phraseology for requesting pushback.
Low Visibility Procedures	Chapter 4 Page 27	Additional text and example of phraseology for broadcast messages regarding low visibility procedures.
Messages regarding the Safety of an Aircraft	Chapter 4 Page 28	Additional text and example of phraseology for messages regarding the safety of an aircraft.
Messages regarding Wildlife	Chapter 4 Page 28	Additional text and example of phraseology for messages regarding wildlife on an aerodrome.
Driver Unsure of Position	Chapter 4 Page 28	Additional text and example of phraseology for a driver lost or unsure of position on the aerodrome.
Broken Down Vehicle	Chapter 4 Page 28	Additional text and example of phraseology for a vehicle broken down on the aerodrome.
Radio Failure	Chapter 4 Page 29	Additional text and example of phraseology for a vehicle with radio failure.
Runway Visual Range (RVR) Visibility	Chapter 4 Page 41	Addition of 'metres' to RVR observations to comply with ICAO Annex 3.
Runway Surface Conditions	Chapter 4 Page 42	Inclusion of runway designator in transmissions of runway conditions to comply with ICAO Doc 4444.
Automatic Terminal Information Service (ATIS) UK	Chapter 4 Page 42	Amendment to content of ATIS broadcast to comply with ICAO Annex 11.
ATS Surveillance Service	Chapter 5 Page 1, 2 and 4	Phraseology remains unchanged but introduces term 'ATS surveillance service' as defined in ICAO Doc 4444.
Radar Vectoring	Chapter 5 Page 5	Inclusion of note reminding controllers that the instruction 'resume own navigation direct ' should be used where a direct route is required after a period of vectoring.
Traffic Information and Avoiding Action Phraseology	Chapter 5 Page 5	Provides for the optional inclusion of the prefix 'left' or 'right' as appropriate in addition to the clock code.

Communications and Loss of Communications	Chapter 5 Page 7	Provides for inclusion of position information in accordance with ICAO Doc 4444.
IFR Arrivals	Chapter 6 Page 4	Insertion of note to state that where it is not practicable to provide an expected clearance time, the time check and expected clearance time may be omitted.
Vectoring to Final Approach	Chapter 6 Page 10	Correction of transposed symbols.
NDB(L) and VOR Procedures	Chapter 6 Page 16	Change of phraseology to specify the type of approach in place of 'beacon approach'.
NDB(L) and VOR Procedures	Chapter 6 Page 17 and 18	Inclusion of diagrams illustrating positions where radio calls are to be made during non-precision approaches.
Clearance to enter Control Zones (CTR)	Chapter 6 Page 27	Additional text and example phraseology for requesting clearance to enter a CTR.
Military Aerodrome Traffic Zones (MATZ) and Penetration Service	Chapter 6 Page 28	Amended phraseology reflecting requirement for MATZ penetration to include explicit permission to enter any associated ATZ.
Aerodrome Traffic Zone (ATZ) associated with another Aerodrome	Chapter 6 Page 30	Introduces phraseology for use by controllers providing a service to an aircraft in uncontrolled airspace approaching an ATZ associated with another aerodrome.
Air Traffic Services Outside Controlled Airspace (ATSOCAS)	Chapter 6 Page 30 to 34	Introduces phraseology associated with revised ATSOCAS introduced from 12 March 2009.
Speed Adjustment	Chapter 7 Page 2	Introduction of new phraseology for speed adjustment at or near the change from Mach number to Indicated Airspeed.
Flights Joining Airways	Chapter 7 Page 2	Insertion of note to state that where it is not practicable to provide an expected clearance time, the time check and expected clearance time may be omitted.
Wake Turbulence	Chapter 9 Page 1	Introduction of phraseology 'wake turbulence' instead of 'vortex wake' to comply with ICAO Doc 4444.
En-route Flight	Chapter 10 Page 20	Introduces phraseology for activation of filed flight plan.

Flight Receiving Lower Airspace Radar Service and MATZ Penetration Service	Chapter 10 Page 21 and 22	Amended phraseology reflecting requirement for MATZ penetration to include explicit permission to enter any associated ATZ.
UK Differences to ICAO Radiotelephony Procedures	Appendix 1	Additional text detailing significant differences between the ICAO standard phraseology and that specified for use in CAP 413.

4 Revisions included in Edition 19

4.1 In addition to editorial changes and minor corrections, Edition 19 comprises:

Use of term 'FISO'	Throughout Document	Term FISO used throughout document to align with Air Navigation Order.
Cross References	Throughout Document	Where no civil phraseology exists or military phraseology differs from civil usage, inclusion of cross references from civil to military examples.
Foreword	Foreword Page 1	Addition of text explaining the scope of the revised Manual and new Chapter 10 (Military Specific Phraseology).
Definitions and Abbreviations	Glossary	Inclusion of additional definitions and abbreviations resulting from expansion of the Manual and revised definition of 'holding point'.
Transmitting Technique	Chapter 2 Page 1	Inclusion of additional guidance regarding length and complexity of messages.
Transmission of Numbers	Chapter 2 Page 3	Airspeed included in list of items, each digit of which shall be transmitted separately.
Standard Words and Phrases	Chapter 2 Page 4	RTF phraseology when referring to 8.33 kHz frequencies.
Standard Words and Phrases	Chapter 2 Page 5	Note regarding use of "break break" added.
Callsigns for Aeronautical Stations	Chapter 2 Page 7	Additional callsign information added and information for controllers regarding telephone and intercom usage deleted. See CAP 493 (Manual of Air Traffic Services Part 1).
Callsigns for Aircraft	Chapter 2 Page 8	Additional guidance regarding callsign confusion.
Callsigns for Aircraft	Chapter 2 Page 9	Introduces callsign suffix 'Super' for A380 aircraft.
Callsigns for Aircraft	Chapter 2 Page 9	Inclusion of information on military aircraft callsigns.

Transfer of Communications	Chapter 2 Page 13 and 14	Additional information and phraseology examples for transfer of communication.
Clearance Issue and Readback Requirements	Chapter 2 Page 16	Guidance to controllers regarding amendment to clearances and repetition of critical information in cases of doubt.
Withholding Clearances	Chapter 2 Page 17	Phraseology to be used by controllers when a clearance is withheld.
Level Reporting	Chapter 3 Page 3 and 4	Additional phraseology examples for level instructions, including VMC climb/descent.
Speed Control	Chapter 3 Page 5	Additional phraseology examples for speed instructions, and inclusion of information previously published in Chapter 7 (Area Phraseology).
Subsequent Frequency Changes	Chapter 3 Page 6	Clarification of content of initial call.
Reply to "Pass Your Message"	Chapter 3 Page 7	Clarification of usage.
Position Reporting	Chapter 3 Page 9	Additional example of instruction to omit position reports.
Low Visibility Procedures	Chapter 3 Page 10	Phraseology examples for low visibility procedures (LVPs).
Delays	Chapter 3 Page 10	Phraseology examples used to advise pilots of delays.
Taxi Instructions	Chapter 4 Page 4	Additional examples of runway crossing instructions.
Pre-Departure Manoeuvring	Chapter 4 Page 5	Additional examples of holding instructions.
Take-Off Clearance	Chapter 4 Page 6	Example of phraseology for request and transmission of instantaneous wind.
	Chapter 4 Page 6	Inclusion of additional guidance and phraseology examples for immediate take-off.
	Chapter 4 Page 8	Additional phraseology examples for departure instructions.
Aerodrome Traffic Circuit	Chapter 4 Page 11	Phraseology examples for overhead join and position reports in the circuit.
Final Approach and Landing	Chapter 4 Page 14	Example of instantaneous wind phraseology.
	Chapter 4 Page 15	Additional examples of low approach phraseology.
Runway Vacating and Communicating After Landing	Chapter 4 Page 16	Example of instruction to give way to another aircraft.

Helicopter Hover Phraseology Examples (ATC and AFIS only)	Chapter 4 Page 24	Additional phraseology examples.
Helicopter Taxiing Phraseology Examples (ATC and AFIS only)	Chapter 4 Page 25	Additional phraseology example for ground taxi.
Aerodrome AGCS – Phraseology and Examples	Chapter 4 Page 34	Correction of phraseology requesting traffic information when in transit.
Runway Visual Range (RVR) Visibility/Absolute Minimum	Chapter 4 Page 43	Inclusion of additional phraseology examples for RVR transmission and advising pilot of absolute minimum.
Radar Identification of Aircraft	Chapter 5 Page 2	Additional phraseology example combining heading and level report.
	Chapter 5 Page 2	Changes to requirements for providing position information and addition of note describing extent of controller responsibility when identifying an aircraft receiving a Basic Service.
Secondary Radar Surveillance Phraseology	Chapter 5 Page 3 Table 2	Additional guidance and phraseology used to verify squawk.
Radar Vectoring	Chapter 5 Page 5	Additional examples of vectoring instructions.
	Chapter 5 Page 5	Provision of position information following a period of vectoring subject to discretion of the controller.
Traffic Information and Avoiding Action Phraseology	Chapter 5 Page 6	Additional examples of avoiding action phraseology.
Essential Traffic Information	Chapter 5 Page 8	Inclusion of phraseology for passing essential traffic information when traffic is separated by less than specified standard separation.
Danger Area Crossing / Danger Area Activity Information Service	Chapter 5 Page 9	Revised Danger Area phraseology
IFR Arrivals	Chapter 6 Page 5 and 6	Expanded phraseology examples for IFR arrivals.
VFR Arrivals	Chapter 6 Page 7 and 8	Minor corrections and additional examples of phraseology used to flights operating under VFR in Class D airspace.
Vectoring to Final Approach	Chapter 6 Page 11	Inclusion of phraseology for use when vectoring an aircraft through the final approach track.
Direction Finding (DF)	Chapter 6 Page 12	Addition of note that bearing class may be omitted after passing the initial bearing.

Surveillance Radar Approach (SRA)	Chapter 6 Page 22	Closing information added to examples.
PAR Approach	Chapter 6 Page 24	PAR phraseology now published in Chapter 10 (Military Specific Phraseology).
Military Aerodrome Traffic Zone (MATZ) and Penetration Services	Chapter 6 Page 25	MATZ phraseology now published in Chapter 10 (Military Specific Phraseology).
Reduced Traffic Information	Chapter 6 Page 28	Expanded guidance regarding reduced traffic information.
Speed Adjustment	Chapter 7 Page 2	Information regarding speed control near transition from Mach number to IAS moved to Chapter 3 (General Phraseology).
Emergency Phraseology	Chapter 8 Page 1	Expanded description of D&D services.
Ejection from Aircraft	Chapter 8 Page 4	Phraseology to advise a controller that a pilot is abandoning an aircraft.
Speechless Code	Chapter 8 Page 4	Existing section deleted and replaced by section in Chapter 10 (Military Specific Phraseology).
Emergency Descent	Chapter 8 Page 6	Inclusion of controller phraseology for use during emergency descent.
Wake Turbulence	Chapter 9 Page 1	Expansion of and revision to existing section on wake turbulence.
Use of ATS Frequencies for Aircraft Operating Agency Message	Chapter 9 Page 4	Additional guidance for controllers regarding use of ATS frequencies for company messages.
Mareva Injunctions	Chapter 9 Page 6	Introduction of controller phraseology for Mareva injunctions.
CPDLC Failure	Chapter 9 Page 7	Introduction of phraseology for CPDLC failure.
Aerodrome Emergency Services	Chapter 9 Page 7	Introduction of phraseology for messages from the Aerodrome Authority regarding aerodrome emergency services.
Military Specific Phraseology	Chapter 10	New chapter detailing phraseology for use by military controllers and aircrew. Civil pilots visiting military aerodromes will be expected to be aware of the military phraseology in Chapter 10.
Flight in the Military Visual Circuit	Chapter 11 Page 26	Deletion of notes relating to obsolete military phraseology and inclusion of new DACS phraseology.
Appendix 1	Appendix 1 Page 2	Addition of information regarding UK use of 'pass your message'.
Appendix 2	Appendix 2	New appendix detailing UK civil / military radiotelephony differences.

5 Revisions included in Edition 20

5.1 In addition to editorial changes and minor corrections, Edition 20 comprises:

Glossary	Chapter 1 Paragraph 1.2.2	Addition of Clearance Delivery Officer and Combined Military Aerodrome Traffic Zone.
Radiotelephony	Chapter 2 Paragraph 1.6	'Negative I say again' and 'Recleared' added to Table 7.
	Chapter 2 Paragraph 1.7.1	Clearance Delivery added to Table 8.
	Chapter 2 Paragraph 1.8.2	Additions to Table 9, Abbreviated Callsigns.
	Chapter 2 Paragraph 1.14.2	Expansion of Clearance Issue and Read Back Requirements.
General Phraseology	Chapter 3 Paragraph 1.2.3.5	Rewording of Pilot Response to ATC Instructions.
	Chapter 3 Paragraph 1.6	Rewording of Passing Message Details.
Aerodrome Phraseology	Chapter 4 Paragraph 1.5.2	Addition of phraseology for crossing unserviceable stop-bars.
	Chapter 4 Paragraph 1.9.2	Addition of phraseology for cancelling a landing clearance, when reissue is anticipated in good time for a safe landing.
	Chapter 4 Paragraph 4.4	Use of Tow Approved added.
Radar Phraseology	Chapter 5 Paragraph 1.3.1	Barometric Pressure Setting Tool added to Table 2.
	Chapter 5 Paragraph 1.7	ACAS/TCAS phraseology is unchanged, however entry is rewritten.
Approach Phraseology	Chapter 6 Paragraph 1.7.2	Transmit for DF added.
Miscellaneous Phraseology	Chapter 9 Paragraph 1.12.1	Revised Phraseology for depletion of Aerodrome Emergency Services.

INTENTIONALLY LEFT BLANK

Foreword

1 Document Description

1.1 Document Purpose

- 1.1.1 The aim of the United Kingdom Radiotelephony Manual (CAP 413) is to provide pilots, Air Traffic Services personnel and other ground personnel, both civil and military, with a compendium of clear, concise, standardised phraseology and associated guidance, for radiotelephony (RTF) communication in United Kingdom airspace.

1.2 Document Applicability

- 1.2.1 All users of RTF in the United Kingdom are expected to comply with the phraseology described in this manual.
- 1.2.2 Chapter 10 of this Manual details Military Specific Phraseology for specific use by military ATCOs and military aircrew. The RTF described in Chapter 10 is complementary to NATO STANAG 3817. It is also complementary to the remainder of CAP 413, as it either differs from civil phraseology or there is no equivalent civil phraseology, e.g. in the case of arrestor system procedures.
- 1.2.3 Civil pilots visiting military aerodromes will be expected to be aware of the military phraseology in Chapter 10 and to comply with such instructions as may be issued by military controllers during their visit. Where relevant, cross references from the remainder of CAP 413 to the equivalent military phraseology are provided for the assistance of civil pilots visiting military aerodromes.
- 1.2.4 Operational details can be found in the United Kingdom Aeronautical Information Publication (UK AIP). Phraseology for air traffic controllers (consistent with CAP 413) is also published in the Manual of Air Traffic Services (CAP 493).
- 1.2.5 CAP 413 is also a useful reference for those studying for the UK Flight Radiotelephony Operator's Licence.
- 1.2.6 Candidates for JAA pilot and instrument rating examinations should note that the syllabus for the communications examination is drawn directly from the International Civil Aviation Organisation (ICAO) Annex 10 Volume 2 and ICAO Doc 9432-AN/925 and not CAP 413.

1.3 Document Source

- 1.3.1 The UK RTF Manual is based on ICAO Annex 10 Volume 2 (Communications Procedures) to the Convention on International Civil Aviation and ICAO PANS-ATM (Procedures for Air Navigation Services - Air Traffic Management) Doc. 4444.
- 1.3.2 Where the ICAO standard phraseology may be misunderstood, or has weaknesses in the UK environment, different phraseology has been specified (and notified to ICAO). Significant differences between the ICAO standard phraseology and that specified for use in CAP 413 are described in Appendix 1 to this publication.

1.4 Document Format

- 1.4.1 Examples of phraseology in CAP 413 are intended to be representative of communications in common use. The initial call in a series of messages is shown on the left side of the page; subsequent messages appear in chronological order on the right side of the page.
- 1.4.2 Black text and grey-scale illustrations are used to facilitate printing on monochrome printers.

- 1.4.3 The agency making the transmission is identified by the line style of the frame and a representative symbol (e.g. Aircraft) as follows:

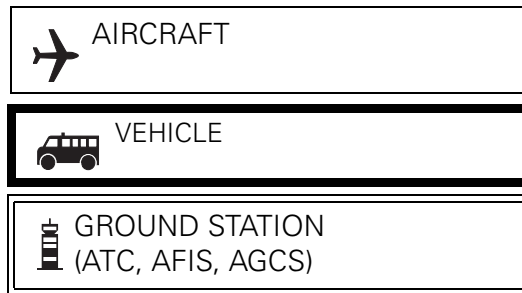

- 1.4.4 In this document the following protocol is used:
- The words '**must**' or '**shall**' indicate that compliance is compulsory.
 - The word '**should**' indicates a recommendation.
 - The word '**may**' indicates an option.
 - The word '**will**' is used to express the future.
- 1.4.5 Any reference in this document to the male gender should be understood to include both male and female persons.
- 1.5 **Document Revisions**
- 1.5.1 Major changes to RTF phraseology are notified by issuing an Aeronautical Information Circular (AIC). Revisions to CAP 413 are published at regular intervals.
- 1.5.2 Regular users of CAP 413 may wish to consider subscribing to the AIC Amendment Service in order to maintain the currency of this publication. Details of this service may be obtained from the Civil Aviation Authority at the address shown on the inside front cover of this document.
- 1.5.3 When appropriate, loose-leaf amendments to this publication will be issued for insertion to the main document. When significant changes occur the document will be reissued as a new edition. The edition number and amendment status of the current version are shown inside the front cover.
- 1.5.4 When issuing amendments or a new edition, significant changes to the text are indicated by the use of sideline revision marks.
- 1.5.5 The revision date of an individual page can be determined from the date shown at the left footer. When a new edition is published, all pages will indicate the effective date of the complete edition.
- 1.5.6 Individual Chapters in this publication are separately numbered to allow for the issue of amendment pages, without the need to renumber and reissue the entire document.
- 1.6 **Document Availability**
- 1.6.1 CAP 413 is available from the Civil Aviation Authority website at **www.caa.co.uk/cap413**. Visitors to the website may view, download and reproduce this file for use by their company or organisation, or for their own personal use.
- 1.6.2 Printed copies of CAP 413 are available for purchase from the CAA's sales agency for printed publications. Contact details are provided on the inside cover of this publication.
- 1.7 **Document Comments and Queries**
- 1.7.1 Should readers have any comments or queries regarding the contents of this document, they should contact the editor at the address provided on the inside cover of the publication.

Chapter 1 Glossary

1 Terms

1.1 Definitions

Absolute Minima A theoretical value, calculated according to the instrument approach and facilities available at the aerodrome, which will be equal to or less than the specified operating RVR for a category A aircraft carrying out that instrument approach.

Advisory Area A designated area where air traffic advisory service is available.

Advisory Route A designated route along which air traffic advisory service is available (ICAO).

Aerodrome Any area of land or water designed, equipped, set apart or commonly used for affording facilities for the landing and departure of aircraft and includes any area or space, whether on the ground, on the roof of a building or elsewhere, which is designed, equipped or set apart for affording facilities for the landing and departure of aircraft capable of descending or climbing vertically, but shall not include any area the use of which for affording facilities for the landing and departure of aircraft has been abandoned and has not been resumed (ANO).

Aerodrome Control Service Air traffic control service for aerodrome traffic. Commission Regulation (EC) 549/2004.

Aerodrome Flight Information Service (AFIS) A flight information service provided to aerodrome traffic.

Aerodrome Operating Minima In relation to the operation of an aircraft at an aerodrome means the cloud ceiling and runway visual range for take-off, and the decision height or minimum descent height, runway visual range and visual reference for landing, which are the minimum for the operation of that aircraft at that aerodrome (ANO).

Aerodrome Traffic All traffic on the manoeuvring area of an aerodrome and all aircraft flying in the vicinity of an aerodrome (ICAO).

Aerodrome Traffic Zone Has the meaning assigned to it by Article 156, ANO 2005.

Aeronautical Mobile Service A mobile service between aeronautical stations and aircraft stations, or between aircraft stations, in which survival craft stations may participate; emergency position-indicating radio beacon stations may also participate in this service on designated distress and emergency frequencies (ICAO).

Aeronautical Station A land station in the aeronautical mobile service. In certain instances, an aeronautical station may be located, for example, on board ship or on a platform at sea (ICAO).

Airborne Collision Avoidance System (ACAS) An aircraft system based on SSR transponder signals which operates independently of groundbased equipment to provide advice to the pilot on potential conflicting aircraft that are equipped with SSR transponders.

Aircraft Station A mobile station in the aeronautical mobile service on board an aircraft.

Air-ground Communications Two-way communication between aircraft and stations or locations on the surface of the earth (ICAO).

Air/Ground Communication Service A service provided from an aerodrome to give information to pilots of aircraft flying in the vicinity of the aerodrome by means of radio signals and 'air/ground communications service unit' shall be construed accordingly (ANO).

AIRPROX A situation in which, in the opinion of a pilot or controller, the distance between aircraft as well as their relative positions and speed have been such that the safety of the aircraft involved was or may have been compromised (ICAO).

Air Traffic All aircraft in flight or operating on the manoeuvring area of an aerodrome (ICAO).

Air Traffic Control Clearance Authorisation for an aircraft to proceed under conditions specified by an air traffic control unit (ICAO).

Air Traffic Service (ATS) A generic term meaning variously: flight information service, alerting service, air traffic advisory service, air traffic control service, (area control service, approach control service or aerodrome control service) (ICAO).

Airway A control area or portion thereof established in the form of a corridor (ICAO).

Altitude The vertical distance of a level, a point or an object considered as a point, measured from mean sea level (ICAO).

Area Control Centre An air traffic control unit established to provide an area control service to aircraft flying within a notified flight information region which are not receiving an aerodrome control service or an approach control service (ANO).

ATS Surveillance Service A service provided directly by means of an ATS surveillance system (ICAO).

Automatic Terminal Information Service (ATIS) The automatic provision of current, routine information to arriving and departing aircraft throughout 24 hours or a specified portion thereof (ICAO).

Base Turn A turn executed by the aircraft during the initial approach between the end of the outbound track and the beginning of the intermediate or final approach track. The tracks are not reciprocal (ICAO).

Basic Service A Basic Service is an ATS provided for the purpose of giving advice and information useful for the safe and efficient conduct of flights. This may include weather information, changes of serviceability of facilities, conditions at aerodromes, general airspace activity information, and any other information likely to affect safety. The avoidance of other traffic is solely the pilot's responsibility.

Blind Transmission A transmission from one station to another station in circumstances where two-way communication cannot be established but where it is believed that the called station is able to receive the transmission (ICAO).

Broadcast A transmission of information relating to air navigation that is not addressed to a specific station or stations (ICAO).

Clearance Limit The point to which an aircraft is granted an air traffic control clearance. A clearance limit shall be described by specifying the name of the appropriate significant point, or aerodrome or controlled airspace boundary (ICAO).

Control Area Controlled airspace which has been further notified as a control area and which extends upwards from a notified altitude or flight level (ANO).

Controlled Airspace Airspace which has been notified as Class A, Class B, Class C, Class D or Class E airspace (ANO).

Control Zone Controlled airspace which has been further notified as a control zone and which extends upwards from the surface (ANO).

Cruising Level A level maintained during a significant portion of a flight (ICAO).

Decision Altitude/Height In relation to the operation of an aircraft at an aerodrome means a specified altitude/height in a precision approach at which a missed approach must be initiated if the required visual reference to continue the approach to land has not been established (ANO).

Deconfliction Service. A Deconfliction Service is a surveillance based ATS where, in addition to the provisions of a Basic Service, the controller provides specific surveillance derived traffic information and issues headings and/or levels aimed at achieving planned deconfliction minima against all observed aircraft in Class F/G airspace, or for positioning and/or sequencing. However, the avoidance of other traffic is ultimately the pilot's responsibility.

Elevation The vertical distance of a point or level on, or affixed to, the surface of the earth measured from mean sea level (ICAO).

Estimated Time of Arrival For IFR flights, the time at which it is estimated that the aircraft will arrive over that designated point, defined by reference to navigation aids, from which it is intended that an instrument approach procedure will be commenced, or, if no navigation aid is associated with the aerodrome, the time at which the aircraft will arrive over the aerodrome. For VFR flights, the time at which it is estimated that the aircraft will arrive over the aerodrome (ICAO).

Flight Information Service Officer (FISO) A Flight Information Service Officer at any aerodrome or area control centre.

Flight Level One of a series of levels of equal atmospheric pressure, separated by notified intervals and each expressed as the number of hundreds of feet which would be indicated at that level on a pressure altimeter calibrated in accordance with the International Standard Atmosphere and set to 1013.2 millibars (ANO).

Flight Plan Specified information provided to air traffic services units, relative to an intended flight or portion of a flight of an aircraft (ICAO).

General Air Traffic Flights operating in accordance with civil air traffic procedures.

Heading The direction in which the longitudinal axis of an aircraft is pointed, usually expressed in degrees from North (true, magnetic, compass or grid) (ICAO).

Height The vertical distance of a level, a point, or an object considered as a point measured from a specified datum (ICAO).

Holding Point A speech abbreviation used in radiotelephony phraseology having the same meaning as Taxiway Holding Position or Runway Holding Position.

Identification The situation which exists when the position indication of a particular aircraft is seen on a situation display and positively identified (ICAO).

IFR Flight A flight conducted in accordance with the Instrument Flight Rules (RoA).

Instrument Meteorological Conditions (IMC) Weather precluding flight in compliance with the Visual Flight Rules (ANO).

Known Traffic Traffic, the current flight details and intentions of which are known to the controller concerned through direct communication or co-ordination.

Level A generic term relating to the vertical position of an aircraft in flight and meaning variously: height, altitude or flight level (ICAO).

Level Bust Any deviation from assigned altitude, height or flight level in excess of 300 feet.

Microwave Approach An approach executed by an aircraft, utilising a Microwave Landing System (MLS) for guidance.

Minimum Descent Altitude/Height In relation to the operation of an aircraft at an aerodrome means the altitude/height in a non-precision approach below which descent may not be made without the required visual reference (ANO).

Missed Approach Point (MAPt) The point in an instrument approach procedure at or before which the prescribed missed approach procedure must be initiated in order to ensure that the minimum obstacle clearance is not infringed.

Missed Approach Procedure The procedure to be followed if the approach cannot be continued (ICAO).

Procedural Service A Procedural Service is an ATS where, in addition to the provisions of a Basic Service, the controller provides vertical, lateral, longitudinal and time instructions, which if complied with, shall achieve deconfliction minima against other aircraft participating in the Procedural Service. Neither traffic information nor deconfliction advice can be passed with respect to unknown traffic.

Procedure Turn A manoeuvre in which a turn is made away from a designated track followed by a turn in the opposite direction to permit the aircraft to intercept and proceed along the reciprocal of the designated track (ICAO).

Radar Approach An approach in which the final approach phase is executed under the direction of a controller using radar (ICAO).

Radar Contact The situation which exists when the radar position of a particular aircraft is seen and identified on a situation display (ICAO).

Reporting Point A specified geographical location in relation to which the position of an aircraft can be reported (ICAO).

Runway A defined rectangular area on a land aerodrome prepared for the landing and take-off of aircraft (ICAO).

Runway Visual Range The range over which the pilot of an aircraft on the centre line of a runway can expect to see the runway surface markings, or the lights delineating the runway or identifying its centre line (ICAO).

SAFETYCOM A common frequency (135.475MHz) made available for use at aerodromes where no other frequency is allocated, to enable pilots to broadcast their intentions to other aircraft that may be operating on, or in the vicinity of, the aerodrome.

Signal Area An area on an aerodrome used for the display of ground signals.

Significant Point A specified geographical location used in defining an ATS route or the flight path of an aircraft and for other navigational and ATS purposes (ICAO).

Special VFR Flight A flight made at any time in a control zone which is Class A airspace or is in any other control zone in IMC or at night, in respect of which the appropriate air traffic control unit has given permission for the flight to be made in accordance with special instructions given by that unit, instead of in accordance with the Instrument Flight Rules and in the course of which flight the aircraft complies with any instructions given by that unit and remains clear of cloud and with the surface in sight (RoA).

Straight Ahead When used in departure clearances means: 'track extended runway centre-line'. When given in Missed Approach Procedures means: 'continue on Final Approach Track'.

Terminal Control Area A control area normally established at the confluence of airways in the vicinity of one or more major aerodromes (ICAO).

Threshold The beginning of that portion of the runway useable for landing (ICAO).

Traffic Alert and Collision Avoidance System (TCAS) See Airborne Collision Avoidance System (ACAS).

Traffic Service A Traffic Service is a surveillance ATS, where in addition to the provisions of a Basic Service, the controller provides specific surveillance derived traffic information to assist the pilot in avoiding other traffic. Controllers may provide headings and/or levels for the purposes of positioning and/or sequencing; however, the controller is not required to achieve deconfliction minima, and the avoidance of other traffic is ultimately the pilot's responsibility.

Vectoring Provision of navigational guidance to aircraft in the form of specific headings, based on the use of an ATS surveillance system (ICAO).

VFR Flight A flight conducted in accordance with the visual flight rules (RoA).

Visual Meteorological Conditions (VMC) Weather permitting flight in accordance with the Visual Flight Rules (ANO).

1.2 Abbreviations

- 1.2.1 The following abbreviations are those in common use in the United Kingdom. If RTF transmission of an abbreviation is required, and the format is not specified in this document, the format specified by ICAO (see ICAO PANS-ABC Doc. 8400) should be used. If no format is defined, the abbreviation should be described using the phonetic alphabet.
- 1.2.2 The abbreviations annotated with an asterisk are normally spoken as complete words. The remainder are normally spoken using the constituent letters rather than the spelling alphabet. Military abbreviations are marked with '(M)'.

A

AAIB	Air Accident Investigation Branch
aal	Above Aerodrome Level
ACAS*	Airborne Collision Avoidance System (pronounced A-kas) (see TCAS)
ACC	Area Control Centre
ADF	Automatic Direction-Finding Equipment
ADR	Advisory Route
ADT	Approved Departure Time
AEF	Air Experience Flight (M)
AFTN	Aeronautical Fixed Telecommunication Network
AFIS	Aerodrome Flight Information Service
AGCS	Air Ground Communication Service
agl	Above Ground Level

AIC	Aeronautical Information Circular
AIP	Aeronautical Information Publication
AIRPROX*	Aircraft Proximity (replaces Airmiss/APHAZ)
AIS	Aeronautical Information Services
amsl	Above Mean Sea Level
ANO	Air Navigation Order
APAPI	Abbreviated Precision Approach Path Indicator (pronounced Ay-PAPI)
ATA	Actual Time of Arrival
ATC	Air Traffic Control (in general)
ATCO*	Air Traffic Control Officer (M)
ATD	Actual Time of Departure
ATIS*	Automatic Terminal Information Service
ATS	Air Traffic Service
ATSU	Air Traffic Service Unit
ATSOCAS	Air Traffic Services outside Controlled Airspace
AT-VASIS	Abbreviated T Visual Approach Slope Indicator System (pronounced Ay-Tee-VASIS)
ATZ	Aerodrome Traffic Zone

C

CAA	Civil Aviation Authority
CAVOK*	Visibility, cloud and present weather better than prescribed values or conditions (CAVOK pronounced Cav-okay)
C/S	Callsign
CDO	Clearance Delivery Officer
CMATZ	Combined Military Aerodrome Traffic Zone
CPDLC	Controller Pilot Data Link Communication (pronounced See Pee Dee Ell See) - A means of communication between a controller and aircrew using data link in conjunction with or instead of voice, for ATC.
CTA	Control Area
CTR	Control Zone

D

DAAIS*	Danger Area Activity Information Service (DAAIS pronounced DAY-ES)
DACS*	Danger Area Crossing Service
DF	Direction Finding

DME	Distance Measuring Equipment
DR	Dead Reckoning
E	
EAT	Expected Approach Time
ETA	Estimated Time of Arrival
ETD	Estimated Time of Departure
EGNOS*	European geostationary navigation overlay service
F	
FAF	Final Approach Fix
FIR	Flight Information Region
FTU	Flying Training Unit (M)
FISO*	Flight Information Service Officer
FL	Flight Level
Ft	Foot (feet)
G	
GAT	General Air Traffic
GBAS*	Ground-based augmentation system (pronounced GEE-BAS)
GS	Gliding School (M)
GLONASS*	Global Orbiting Navigation Satellite System (pronounced Glo-NAS)
GMC	Ground Movement Control
GNSS	Global Navigation Satellite System
GPS	Global Positioning System
GRAS*	Ground-based regional augmentation system (pronounced GRASS)
H	
H24	Continuous day and night service (H24 pronounced Aitch Twenty Fower)
HF	High Frequency
HJ	Sunrise to Sunset
HN	Sunset to Sunrise
I	
IAF	Initial Approach Fix
IAS	Indicated Air Speed

ICAO*	International Civil Aviation Organisation
IF	Intermediate Approach Fix
IFR	Instrument Flight Rules
ILS	Instrument Landing System
IMC	Instrument Meteorological Conditions
IRVR	Instrumented Runway Visual Range

K

Kg	Kilogramme(s)
kHz	Kilohertz
Km	Kilometre(s)
kt	Knot(s)

M

MAPt	Missed Approach Point
MATZ*	Military Aerodrome Traffic Zone
mb	Millibars
MDA/H	Minimum Descent Altitude/Height
MEDA*	Military Emergency Diversion Aerodrome
MET*	Meteorological or Meteorology
METAR*	Routine aviation aerodrome weather report
MHz	Megahertz
MLS	Microwave Landing System
MOR	Mandatory Occurrence Report

N

NATS*	National Air Traffic Services
NDB	Non-Directional Radio Beacon

O

OAC	Oceanic Area Control Unit
OCA	Oceanic Control Area
OCA/H	Obstacle Clearance Altitude/Height
OPC	Operational Control Communications
OCU	Operational Conversion Unit (M)

P

PAPI*	Precision Approach Path Indicator (pronounced PAPI)
POB	(Total) Persons on Board
PAR	Precision Approach Radar (M)

Q

QDM	Magnetic heading (zero wind) (Sometimes employed to indicate magnetic heading of a runway)
QDR	Magnetic bearing
QFE	Altimeter subscale setting to indicate height above either aerodrome elevation, or threshold elevation, or helideck elevation
QNE	Landing altimeter reading when subscale set 1013 millibars
QNH	Altimeter subscale setting to indicate elevation (AMSL) when on the ground and altitude in the air
QTE	True Bearing

R

RA	Resolution Advisory (see TCAS)
RCC	Rescue Co-ordination Centre
RPS	Regional Pressure Setting
RTF	Radiotelephone/Radiotelephony
RVR	Runway Visual Range
RVSM	Reduced Vertical Separation Minima (pronounced Ahh Vee Ess Emm)

S

SAR	Search and Rescue
SBAS*	Satellite-based augmentation system (pronounced ESS-BAS)
SID*	Standard Instrument Departure
SIGMET*	Significant information concerning en-route weather phenomena which may affect the safety of aircraft operations
SRA	Surveillance Radar Approach
SSR	Secondary Surveillance Radar
STANAG*	Standing Agreement (M)
STAR*	Standard Instrument Arrival

T

TA	Traffic Advisory (see TCAS)
TAF*	Terminal Aerodrome Forecast
TCAS*	Traffic Alert and Collision Avoidance System (pronounced Tee-kas) (see ACAS)
TMA	Terminal Control Area
T-VASIS	T Visual Approach Slope Indicator System (pronounced TEE-VASIS)
TWU	Tactical Weapons Unit (M)

U

UAS	Upper Airspace
UAS	University Air Squadron (M)
UHF	Ultra-High Frequency
UIR	Upper Flight Information Region
USAF	United States Air Force (M)
UTC	Co-ordinated Universal Time

V

VASIS*	Visual Approach Slope Indicator System (pronounced VASIS)
VDF	Very High Frequency Direction-Finding Station
VFR	Visual Flight Rules
VHF	Very High Frequency (30 to 300 MHz)
VMC	Visual Meteorological Conditions
VOLMET*	Meteorological information for aircraft in flight
VOR	VHF Omnidirectional Radio Range
VORTAC*	VOR and TACAN combination

Chapter 2 Radiotelephony

1 General Procedures

1.1 Introduction

Radiotelephony provides the means by which pilots and ground personnel communicate with each other. Used properly, the information and instructions transmitted are of vital importance in assisting in the safe and expeditious operation of aircraft. However, the use of non-standard procedures and phraseology can cause misunderstanding. Incidents and accidents have occurred in which a contributing factor has been the misunderstanding caused by the use of non-standard phraseology. **The importance of using correct and precise standard phraseology cannot be over-emphasised.**

1.2 Transmitting Technique

1.2.1 The following transmitting techniques will assist in ensuring that transmitted speech is clearly and satisfactorily received.

- a) Before transmitting check that the receiver volume is set at the optimum level and listen out on the frequency to be used to ensure that there will be no interference with a transmission from another station.
- b) Be familiar with microphone operating techniques and do not turn your head away from it whilst talking or vary the distance between it and your mouth. Severe distortion of speech may arise from:
 - i) talking too close to the microphone;
 - ii) touching the microphone with the lips; or
 - iii) holding the microphone or boom (of a combined headset/microphone system).
- c) Use a normal conversation tone, speak clearly and distinctly.
- d) Maintain an even rate of speech not exceeding 100 words per minute. When it is known that elements of the message will be written down by the recipients, speak at a slightly slower rate.
- e) Maintain the speaking volume at a constant level.
- f) A slight pause before and after numbers will assist in making them easier to understand.
- g) Avoid using hesitation sounds such as 'er'.
- h) Avoid excessive use of courtesies and entering into non-operational conversations.
- i) Depress the transmit switch fully before speaking and do not release it until the message is complete. This will ensure that the entire message is transmitted. However, do not depress transmit switch until ready to speak.
- j) Be aware that the mother tongue of the person receiving the message may not be English. Therefore, speak clearly and use standard radiotelephony (RTF) words and phrases wherever possible.
- k) Messages should not contain more than three specific phrases, comprising a clearance, instruction or pertinent information. In cases of doubt, e.g. a foreign pilot having difficulty with the English language or an inexperienced pilot unsure of the procedures, the controller should reduce the number of items and if necessary these should be passed, and acknowledged, singly.

1.2.2 One of the most irritating and potentially dangerous situations in radiotelephony is a 'stuck' microphone button. Operators should always ensure that the button is released after a transmission and the microphone placed in an appropriate place that will ensure that it will not inadvertently be switched on.

1.2.3 After a call has been made, a period of at least 10 seconds should elapse before a second call is made. This should eliminate unnecessary transmissions while the receiving station is getting ready to reply to the initial call.

1.3 Transmission of Letters

1.3.1 The words in the table below shall be used when individual letters are required to be transmitted. The syllables to be emphasised are underlined.

Table 1

Letter	Word	Appropriate pronunciation
A	Alpha	<u>AL</u> FAH
B	Bravo	<u>BRAH</u> VOH
C	Charlie	<u>CHAR</u> LEE
D	Delta	<u>DELL</u> TAH
E	Echo	<u>ECK</u> OH
F	Foxtrot	<u>FOKS</u> TROT
G	Golf	GOLF
H	Hotel	HOH <u>TELL</u>
I	India	<u>IN</u> DEE AH
J	Juliett	<u>JEW</u> LEE <u>ETT</u>
K	Kilo	<u>KEY</u> LOH
L	Lima	<u>LEE</u> MAH
M	Mike	MIKE
N	November	NO <u>VEM</u> BER
O	Oscar	<u>OSS</u> CAH
P	Papa	PAH <u>PAH</u>
Q	Quebec	KEH <u>BECK</u>
R	Romeo	<u>ROW</u> ME OH
S	Sierra	SEE <u>AIR</u> RAH
T	Tango	<u>TANG</u> GO
U	Uniform	<u>YOU</u> NEE FORM
V	Victor	<u>VIK</u> TAH
W	Whiskey	<u>WISS</u> KEY
X	X-ray	<u>ECKS</u> RAY
Y	Yankee	<u>YANG</u> KEE
Z	Zulu	<u>ZOO</u> LOO

1.4 Transmission of Numbers

1.4.1 The syllables to be emphasised are underlined.

Table 2

Numeral or numeral element	Latin alphabet representation
0	<u>Z</u> ERO
1	<u>W</u> UN
2	<u>T</u> OO
3	<u>T</u> REE
4	<u>F</u> OWER
5	<u>F</u> IFE
6	<u>S</u> IX
7	<u>S</u> EVEN
8	<u>A</u> IT
9	<u>N</u> INER
Decimal	<u>D</u> AY <u>S</u> EEM <u>A</u> L
Hundred	<u>H</u> UN <u>D</u> RED
Thousand	<u>T</u> OU <u>S</u> AND

1.4.2 All numbers, except those contained in paragraph 1.4.2 b) shall be transmitted by pronouncing each digit separately as follows:

a) When transmitting messages containing aircraft callsigns, altimeter settings, flight levels (with the exception of FL100, 200, 300 etc. which are expressed as 'Flight Level (number) HUN DRED'), headings, wind speeds/directions, pressure settings, airspeed, transponder codes and frequencies, each digit shall be transmitted separately; examples of this convention are as follows:

Table 3

Number	Transmitted as	Pronounced as
BAW246	Speedbird Two Four Six	SPEEDBIRD TOO FOWER SIX
FL100	Flight Level One Hundred	FLIGHT LEVEL WUN HUN DRED
FL180	Flight Level One Eight Zero	FLIGHT LEVEL WUN AIT ZERO
150 Degrees	One Five Zero Degrees	WUN FIFE ZERO DEGREES
18 Knots	One Eight Knots	WUN AIT KNOTS
122.1	One Two Two Decimal One	WUN TOO TOO DAYSEEMAL WUN
(Squawk) 6500	Six Five Zero Zero	SIX FIFE ZERO ZERO

- b) All numbers used in the transmission of altitude, height, cloud height, visibility and runway visual range information which contain whole hundreds and whole thousands shall be transmitted by pronouncing each digit in the number of hundreds or thousands followed by the word HUNDRED or TOUSAND as appropriate. Combinations of thousands and whole hundreds shall be transmitted by pronouncing each digit in the number of thousands followed by the word TOUSAND and the number of hundreds followed by the word HUNDRED; examples of this convention are as follows:

Table 4

Number	Transmitted as	Pronounced as
10	One Zero	WUN ZERO
100	One Hundred	WUN HUN DRED
2 500	Two Thousand Five Hundred	TOO TOUSAND FIFE HUNDRED
11 000	One One Thousand	WUN WUN TOUSAND
25 000	Two Five Thousand	TOO FIFE TOUSAND

- 1.4.3 Numbers containing a decimal point shall be transmitted as prescribed in 1.4.1 with the decimal point in appropriate sequence being indicated by the word decimal.
- 1.4.4 All six figures shall be used when identifying frequencies irrespective of whether they are 25 kHz or 8.33 kHz spaced. Exceptionally, when the final two digits of the frequency are both zero, only the first four digits need be given. In technical terms an 8.33 kHz frequency is referred to as a "channel", however the word "channel" is not used in RTF. Military phraseology for identifying UHF frequencies appears in Chapter 10 paragraph 2.1.

Table 5

Frequency	Transmitted as	Pronounced as
118.125	One One Eight Decimal One Two Five	WUN WUN AIT DAY SEE MAL WUN TOO FIFE
119.050	One One Nine Decimal Zero Five Zero	WUN WUN NINER DAY SEE MAL ZERO FIFE ZERO
122.500	One Two Two Decimal Five	WUN TOO TOO DAY SEE MAL FIFE
118.000	One One Eight Decimal Zero	WUN WUN AIT DAY SEE MAL ZERO

- 1.4.5 When it is necessary to verify the accurate reception of numbers the person transmitting the message shall request the person receiving the message to read back the numbers.
- 1.5 **Transmission of Time**
- 1.5.1 When transmitting time, only the minutes of the hour are normally required. However, the hour should be included if there is any possibility of confusion. Time checks shall be given to the nearest minute and preceded by the word 'TIME'. Co-ordinated Universal Time (UTC) is to be used at all times, unless specified. 2400 hours designates midnight, the end of the day, and 0000 hours the beginning of the day.

Table 6

Number	Transmitted as	Pronounced as
0823	Two Three or Zero Eight Two Three	TOO TREE (or ZERO AIT TOO TREE)
1300	One Three Zero Zero	WUN TREE ZERO ZERO
2057	Five Seven or Two Zero Five Seven	FIFE SEVEN (or TOO ZERO FIFE SEVEN)

1.6 Standard Words and Phrases

The following words and phrases shall be used in radiotelephony communications as appropriate and shall have the meaning given below:

Table 7

Word/Phrase	Meaning
ACKNOWLEDGE	Let me know that you have received and understood this message.
AFFIRM	Yes.
APPROVED**	Permission for proposed action granted.
BREAK	Indicates the separation between messages.
BREAK BREAK	Indicates the separation between messages transmitted to different aircraft in a busy environment.
NOTE: The phraseology "BREAK BREAK" may be confused with an instruction to an aircraft formation and should be used with caution.	
CANCEL	Annul the previously transmitted clearance.
CHANGING TO	I intend to call . . . (unit) on . . . (frequency).
CHECK	Examine a system or procedure. (Not to be used in any other context. No answer is normally expected.)
CLEARED ‡	Authorised to proceed under the conditions specified.
CLIMB ‡	Climb and maintain.
CONFIRM	I request verification of: (<i>clearance, instruction, action, information</i>).
CONTACT	Establish communications with ... (your details have been passed).
CORRECT	True or accurate.
CORRECTION	An error has been made in this transmission (or message indicated). The correct version is ...
DESCEND ‡	Descend and maintain.
DISREGARD	Ignore.
FANSTOP	I am initiating a practice engine failure after take off. (Used only by pilots of single engine aircraft.) The response should be, "REPORT CLIMBING AWAY".
FREECALL	Call . . . (unit) (your details have not been passed – mainly used by military ATC).

Table 7 (Continued)

Word/Phrase	Meaning
HOLD SHORT**	Stop before reaching the specified location. <i>Note: Only used in limited circumstances where no defined point exists (e.g. where there is no suitably located holding point), or to reinforce a clearance limit.</i>
HOW DO YOU READ	What is the readability of my transmission?
I SAY AGAIN	I repeat for clarity or emphasis.
MAINTAIN ‡	Continue in accordance with the condition(s) specified or in its literal sense, e.g. "Maintain VFR".
MONITOR	Listen out on (frequency).
NEGATIVE	No; or Permission not granted; or That is not correct; or Not capable.
NEGATIVE I SAY AGAIN	May be used if repeated incorrect readbacks are given by the pilot and additional emphasis is required.
OUT*	This exchange of transmissions is ended and no response is expected.
OVER*	My transmission is ended and I expect a response from you.
PASS YOUR MESSAGE	Proceed with your message.
READ BACK	Repeat all, or the specified part, of this message back to me exactly as received.
RECLEARED	To be used only in relation to routings and NOT for instructions to climb or descend.
REPORT **	Pass requested information.
REQUEST	I should like to know ... or I wish to obtain ...
ROGER	I have received all your last transmission. <i>Note: Under no circumstances to be used in reply to a question requiring a direct answer in the affirmative (AFFIRM) or negative (NEGATIVE).</i>
SAY AGAIN	Repeat all, or the following part of your last transmission.
SPEAK SLOWER	Reduce your rate of speech.
STANDBY	Wait and I will call you. <i>Note: No onward clearance to be assumed. The caller would normally re-establish contact if the delay is lengthy. STANDBY is not an approval or denial.</i>
UNABLE	I cannot comply with your request, instruction or clearance. <i>Unable is normally followed by a reason.</i>
WILCO	I understand your message and will comply with it (abbreviation for will comply)
WORDS TWICE	<i>As a request:</i> Communication is difficult. Please send every word twice. <i>As Information:</i> Since communication is difficult, every word in this message will be sent twice.

* Not normally used in U/VHF Communications.

** Not used by Air/Ground Communication Service Operators (c/s "Radio").

‡ Not used by Air/Ground Communication Service Operators (c/s "Radio") or Flight Information Service Officers (c/s "Information").

1.7 Callsigns for Aeronautical Stations

1.7.1 Aeronautical stations are identified by the name of the location followed by a suffix except that the name of the rig/platform/vessel is normally used by offshore mineral extraction agencies. The suffix indicates the type of service being provided.

Table 8

Service	Suffix
Area Control	CONTROL
Radar (in general)	RADAR
Approach Control	APPROACH
Aerodrome Control	TOWER
Approach Control Radar Arrival/Departure	DIRECTOR/DEPARTURE (RADAR – when tasks combined)/ ARRIVAL – (when approved))
Ground Movement Control	GROUND
Military Aerodrome Traffic Zone (MATZ) Crossing	ZONE
Precision Approach Radar	TALKDOWN
Flight Information	INFORMATION
Air/Ground Communication Service	RADIO
Clearance Delivery *	DELIVERY

* Clearance Delivery Officer (CDO) positions may be established at aerodromes to relay ATC departure clearances. Standard phraseology for CDO departure clearance is referenced in Chapter 11, paragraph 1.2.2 A CDO shall not relay start, pushback, taxi, or take off instructions.

NOTE: Lower Airspace Radar Service (LARS) is available from participating ATSUs as described in UK AIP ENR 1.6.3.

1.7.2 There are three main categories of aeronautical communications service:

- Air Traffic Control Service (ATC) which can only be provided by licensed Air Traffic Control Officers who are closely regulated by the relevant regulatory authority.
- Flight Information Service at aerodromes can be provided only by licensed Flight Information Service Officers (FISOs), who are also regulated by the CAA.
- Aerodrome Air/Ground Communication Service (AGCS) which can be provided by Radio Operators who are not licensed but have obtained a certificate of competency to operate radio equipment on aviation frequencies from the CAA. These operations come under the jurisdiction of the radio licence holder, but are not regulated in any other way.

Other categories of aeronautical communications service include VOLMET, SIGMET, Automatic Terminal Information Service (ATIS) or Aeronautical Information Services (AIS).

1.7.3 It is an offence to use a callsign for a purpose other than that for which it has been notified.

- 1.7.4 The use of the calling aeronautical station's callsign followed by the answering aeronautical station's callsign shall be considered the invitation to proceed with transmission by the station calling. The use of the phrase 'Pass your message' may be used when considered appropriate.
- 1.7.5 When satisfactory communication has been established, and provided that it will **not be confusing**, the name of the location or the callsign suffix may be omitted.
- 1.7.6 Telephone procedures to be applied by civil controllers are published in CAP 493 (Manual of Air Traffic Services Part 1).

1.8 Callsigns for Aircraft

- 1.8.1 When establishing communication, an aircraft shall use the full callsigns of both stations.

 Borton Tower, G-ABCD, request Basic Service

 G-ABCD, Borton Tower, pass your message

- 1.8.2 After satisfactory communication has been established and provided that no confusion is likely to occur, the ground station may abbreviate callsigns (see table below). A pilot may **only** abbreviate the callsign of his aircraft if it has **first** been abbreviated by the aeronautical station.

Table 9

Full callsign	Abbreviation
GBFRM	G-RM
Speedbird GBGDC	Speedbird DC
N31029	N029
N753DA	N3DA
* Midland 640	No abbreviation
**Piper GBSZT	Piper ZT
**Helicopter GABCD	Helicopter CD

* Represents a Type C callsign.





** The name of either the aircraft manufacturer, or name of aircraft model, or name of the aircraft category (e.g. helicopter or gyrocopter) may be used as a prefix to the callsign.

- 1.8.3 An aircraft should request the service required on initial contact when freecalling a ground station.

 Westbury Approach, G-ABCD, request Traffic Service

 Wrayton Control, G-ABCD, I wish to file an airborne flight plan

- 1.8.4 An aircraft shall not change its callsign type during a flight. **However**, where there is a likelihood that confusion may occur because of similar callsigns, an aircraft may be instructed by an air traffic service unit (ATSU) to change the type of its callsign temporarily.
- 1.8.5 The similarity of some aircraft callsigns on the same frequency can cause confusion which may lead to an incident. The following are particularly liable to be confused:
- Callsigns which have in common three or more digits, especially when the flight numbers are the same, e.g. AIC 515 and SAS 515;
 - Aircraft with similar registrations, e.g. G-ASSB and G-ATSB or HB-SSB.
- Controllers are to warn the pilots concerned and, if necessary, instruct one or both aircraft to use alternative or full callsigns while they remain on the frequency.
- 1.8.6 Aircraft in the heavy wake turbulence category shall include the word 'HEAVY' immediately after the aircraft callsign in the initial call to each ATSU. The purpose of this call is to confirm the aircraft type and/or wake turbulence category is the same as that stated on the flight progress strip. For the A380 the word "SUPER" is to be included after the callsign on initial contact.
- 1.8.7 On initial contact, student pilots who are flying solo shall use the callsign prefix 'STUDENT'¹. Once acknowledged, it will not normally be necessary for student pilots to use the prefix in subsequent transmissions until making initial contact with other ATSUs, unless they feel they are being instructed to do something with which they are unfamiliar.
- 1.8.8 Controllers will acknowledge the initial call, again using the prefix, and can be expected, in so far as is practicable, to make due allowance for the limited experience and ability of student pilots in determining the pace and complexity of instructions and/or information which are subsequently passed.

 Walden Tower, STUDENT G-ABCD, on the apron, request taxi for local VFR flight	 STUDENT G-ABCD, Walden Tower, taxi holding point Alpha, runway 24
 Wrayton Information, STUDENT G-ABCD, request Basic Service	 STUDENT G-ABCD, Wrayton Information, pass your message

- 1.8.9 Flight Instructors must brief students, specifically, on the use of this callsign prefix as part of their pre-solo briefing. The use of this callsign prefix is not intended to remove the additional requirement for flight instructors to notify ATSUs separately of 'first solo' flights where this is normal practice.
- 1.8.10 When receiving an ATS surveillance service, certain ex-military aircraft types have been granted a CAA exemption from the Air Navigation Order requirement to fly at an IAS less than 250 kt below Flight Level 100. In order to alert the controller to this higher speed profile, pilots of exempted aircraft shall, on initial contact, prefix the aircraft callsign with 'FASTJET' or 'FASTPROP' (depending on propulsion type), e.g. "Kennington Radar, FASTJET G-ABCD request Deconfliction service". Use of this prefix shall be confined to initial contact with ATC agencies for periods of flight during which operations at airspeeds in excess of 250 kt are intended. Once acknowledged, it will not normally be necessary for pilots to use the prefix in subsequent transmissions until making initial contact with other ATSUs.

1. Although intended primarily for use by ab initio students, the prefix shall also be used in other circumstances where, for example, the holder of a valid licence is returning to flying practice after a significant absence and is undergoing renewal training involving solo flight conducted as a student under the supervision of a flight instructor.

1.9 **Military Aircraft Callsigns**

1.9.1 **Aircraft Callsigns**

Military aircraft use callsigns derived from 2 systems. Front line aircraft, in the main, use operational callsigns consisting of a 3 character prefix of numbers and letters (trigraph) suffixed by a 2 number (dinome) mission identifier. Callsigns for Flying Training Units (FTUs) and Search and Rescue (SAR) aircraft use fixed ICAO allocated 3 letter designators with figure suffixes as pilot number callsigns. The term FTU embraces all flying training units (including University Air Squadrons (UASs) and Gliding Schools (GSs)), Maintenance Units and Air Experience Flights (AEFs), plus the Operational Conversion Units (OCUs) of HQ AIR who will nominate which OCUs are not included in the scope of this sub section. The salient features of the 2 systems are outlined in the following paragraphs.

1.9.2 **Mission Number Callsigns**

Mission number callsigns are based on a 3 character group of which the last character is a letter and the first 2 characters are either letter/number or number/letter. They are valid for a 24 hour period but the system has insufficient capacity to provide entirely different callsigns for each individual aircraft sortie. Callsigns are configured using a 3 element base callsign root with a 2 number suffix allocated at random by the tasking agency. If several aircraft in formation make up a single mission, the mission is allocated a single callsign and each aircraft is given a further identifying letter suffix. For example T4G (root plus mission), T4G22A, B, C and D (root, mission and 4 aircraft formation).

1.9.3 **Pilot Number Callsigns**

The Pilot Number Callsign system is based on a 2 or 3-figure pilot number suffix to a 3-letter callsign root, e.g. VYJ 44 or CWP 186:

- Callsign Root. Each major FTU is allocated one CAA approved fixed 3 letter callsign root. Four individual trigraphs are allocated to the UASs, one to all AEFs and one to all GSs.
- Pilot Numbers. Pilot Numbers are allocated as follows:
 - Where possible a Pilot Number is allocated to each pilot when posted to an FTU, and normally is to be retained for the duration of the appointment or course of instruction.
 - For UASs, AEFs and GSs, the respective HQs will allocate blocks of Pilot Numbers to each element to simplify identification of pilots from different elements using the same callsign root.

1.9.4 **Formation Callsigns**

When aircraft are operating as a formation, the use of formation callsigns may be desirable to facilitate communications both within the formation and by the leader with ground stations. Formation callsigns should be as detailed in 1.9.2 above, or as authorised by single Service regulations.

1.9.5 **Word Callsigns**

If 2 or more aircraft are flying as a formation, the formation may be allocated an approved word callsign, in addition to the normal mission/pilot numbers allocated to each aircraft. The mission/pilot numbers will only be used in the event of a split. For the duration of the formation flight, the aircraft should be identified by adding the words 'one', '2', etc. to the formation callsign, e.g. Bear one, Bear 2, etc. Where formations operate using the callsign of the lead aircraft, controllers are to add the word 'flight' or 'formation' to the callsign, when transmitting instructions relevant to the whole formation e.g. 'EAGLE 51 FLIGHT'. Where a transmission is relevant to only one element of the formation, this should be clarified e.g. 'EAGLE 51 ONLY', climb etc.'

Examples of formation callsigns are:

"BLACKCAT" – denotes a UK formation

"BLACKCAT 1" – denotes a UK single element

"DEADLY 31 flight" – denotes a United States Air Force (USAF) formation

"DEADLY 31" – denotes a USAF singleton.

1.9.6 **Search and Rescue Callsigns**

Callsigns for Search and Rescue are to be as follows:

- Fixed wing aircraft on SAR are to use the special 4 letter W/T callsigns, suffixed by a 2 figure Mission Number. For voice, the word 'rescue' is used, suffixed by the Mission Number.
- Helicopters on SAR are to employ the words 'rescue helicopter' suffixed by a Mission Number. SAR squadron helicopters will use Pilot Number callsigns in accordance with paragraph 3 when not engaged in SAR tasks using the trigraph allocated to their base unit.
- SAR callsigns are also listed in the current edition of BAM/25/7.

1.9.7 **Transit Flights**

In the same way that aircraft of civil airlines have a callsign which identifies the parent airline, military aircraft making transit (primarily overseas transit) flights requiring a flight plan to be fed into the civil air traffic system should have a military identifier as an element of the callsign as detailed in single Service regulations.

1.9.8 **Callsign Abbreviation**

Once positive contact has been established, and provided no possibility of confusion exists, callsigns may be abbreviated as follows:

- For transit flights, a military identifier followed by whatever the air traffic controller specifies once the full callsign has been used to identify the aircraft.
- On military communications the abbreviation should be:
 - For Mission Numbers. As only the third element of the trigraph is always a letter, the abbreviated callsign should be the third element followed by the dinome.
 - For Pilot Numbers. The first element of the callsign root followed by the dinome or trinome.

However, in all cases the responsibility to shorten lies with ATC as they may be dealing with many aircraft.

1.10 **Continuation of Communications**

1.10.1 The placement of the callsigns of both the aircraft and the ground station **within** an established RTF exchange should be as follows:

Ground to Air: Aircraft callsign – message or reply.

Air to Ground:

a) Initiation of new information/request etc. – Aircraft callsign then message;

- b) Reply – Repeat of pertinent information/readback/acknowledgement then aircraft callsign.

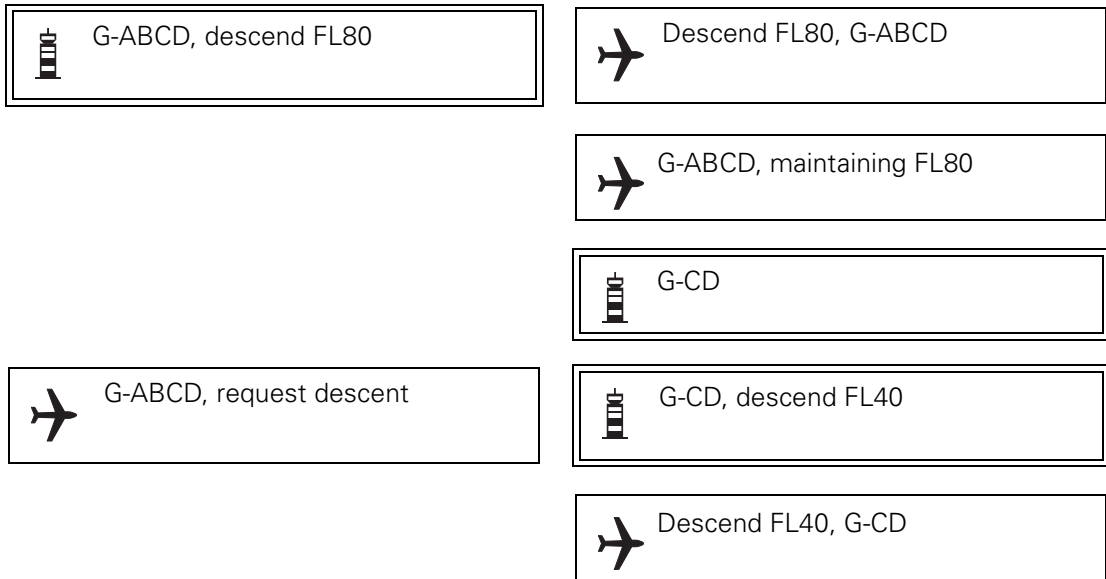

- 1.10.2 When it is considered that reception is likely to be difficult, important elements of the message should be spoken twice.

- 1.10.3 When a ground station wishes to broadcast information to all aircraft likely to receive it, the message should be prefaced by the call 'All stations'.

No reply is expected to such general calls unless individual stations are subsequently called upon to acknowledge receipt.

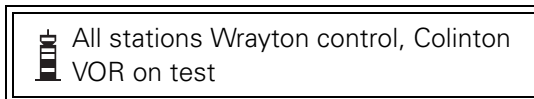



- 1.10.4 If there is doubt that a message has been correctly received, a repetition of the message shall be requested either in full or in part.

Table 10

Phrase	Meaning
Say again	Repeat entire message
Say again ... (item)	Repeat specific item
Say again all before ... (the first word satisfactorily received)	
Say again all after ... (the last word satisfactorily received)	
Say again ... (word before missing portion) to ... (word after missing portion)	

- 1.10.5 When a station is called but is uncertain of the identification of the calling station, the calling station should be requested to repeat its callsign until identification is established.

 Stourton Ground, BIGJET 347

 Station calling Stourton Ground say again your callsign

1.11 Corrections and Repetitions

- 1.11.1 When an error is made in a transmission the word 'CORRECTION' shall be spoken, the last correct group or phrase repeated and then the correct version transmitted.

 BIGJET 347, Wicken 47
FL280 Marlow 07
correction Marlow 57

 BIGJET 347, Roger

- 1.11.2 If a correction can best be made by repeating the entire message, the operator shall use the phrase 'CORRECTION I SAY AGAIN' before transmitting the message a second time.

1.12 Acknowledgement of Receipt

Acknowledgements of information should be signified by the use of the receiving stations' callsign or Roger callsign, and not by messages such as: 'callsign-copy the weather' or 'callsign-copy the traffic'.

1.13 Transfer of Communications

- 1.13.1 To transfer communications with an aircraft to another unit, controllers shall pass instructions giving:

- the identity of the unit to be contacted;
- the frequency to be used for contact.

Transfer of communication instructions should be passed in a single message. Items which require a read-back should normally be passed in a separate transmission before transfer.

- 1.13.2 If no further communication is received from the pilot after an acknowledgement, satisfactory transfer of communication may be assumed.

- 1.13.3 An aircraft will normally be advised by the appropriate aeronautical station to change from one radio frequency to another in accordance with agreed procedures.

 BIGJET 347, contact Wrayton Control 129.125

 Wrayton Control 129.125, BIGJET 347

In the absence of such advice, the aircraft shall notify the aeronautical station before such a change takes place. Aircraft flying in controlled airspace must obtain permission from the controlling authority before changing frequency.

- 1.13.4 An aircraft may be instructed to 'standby' on a frequency when it is intended that the ATSU will initiate communications, and to monitor a frequency on which information is being broadcast.

 BIGJET 347, standby for Kennington Tower 118.950

 Standby for Kennington Tower 118.950, BIGJET 347

 BIGJET 347, monitor ATIS 128.275

 Monitor ATIS 128.275, BIGJET 347

- 1.13.5 The controller may instruct the pilot to contact another agency on passing a specific point or when passing, leaving or reaching a specified level.

 G-CD, at Littletown contact Borton
Approach 122.375

 At Littletown contact Borton
Approach 122.375, G-CD

 BIGJET 347, when passing FL120
contact Wrayton Control 119.725

 When passing FL120 contact
Wrayton Control 119.725, BIGJET
347

- 1.13.6 Where the aircraft is transferred to another agency whilst on a radar heading, the controller will instruct the pilot to report the radar heading to the next agency.

 BIGJET 347, report radar heading to
Wrayton Control, 116.335







- 1.13.7 If the airspace does not dictate that an aircraft must remain in contact with a specific ATSU and the pilot wishes to freecall another agency he should request, or notify such an intention.

 Westbury, G-ABCD, request change
to Wrayton Information 125.750

 Wrayton Information, G-ABCD,
changing to Wrayton Centre 121.5
for Practice Pan

1.14 Clearance Issue and Read Back Requirements

- 1.14.1 Provisions governing clearances are contained in the PANS-ATM (ICAO Doc 4444). A clearance may vary in content from a detailed description of the route and levels to be flown to a brief standard instrument departure (SID) according to local procedures.
- 1.14.2 Controllers will pass a clearance slowly and clearly since the pilot needs to write it down; wasteful repetition will thus be avoided. Whenever possible, a route clearance should be passed to an aircraft before start up and the aircraft's full callsign will always be used. A route clearance and local departure instructions shall not be passed in the same transmission. When a route clearance is passed subsequent to local departure instructions, or to an aircraft that is already airborne, tactical restrictions that remain in place shall be reiterated to ensure that the immediate profile to be flown by the pilot is unambiguous. **Generally, controllers will avoid passing a clearance to a pilot engaged in complicated taxiing manoeuvres and on no occasion when the pilot is engaged in line up or take-off manoeuvres.**
- 1.14.3 An ATC route clearance is **NOT** an instruction to take-off or enter an active runway. **The words 'TAKE-OFF' are used only when an aircraft is cleared for take-off. At all other times the word 'DEPARTURE' is used.**
- 1.14.4 The stringency of the read back requirement is directly related to the possible seriousness of a misunderstanding in the transmission and receipt of ATC clearance and instructions. **ATC route clearances shall always be read back unless otherwise authorised by the appropriate ATS authority** in which case they shall be acknowledged in a positive manner. Read backs shall always include the aircraft callsign.

 BIGJET 347, cleared to Kennington via A1, at FL60, squawk 5501	 Cleared to Kennington via A1, at FL60, squawk 5501, BIGJET 347
 BIGJET 347, cleared to Kennington via A1, Wicken 3 Delta departure, squawk 5501	 Cleared to Kennington via A1, Wicken 3 Delta departure, squawk 5501, BIGJET 347
 G-ABCD, after departure cleared to zone boundary via route Echo. Climb to altitude 2000 feet QNH 1008, squawk 6522	 After departure cleared to zone boundary via route Echo. Climb to altitude 2000 feet QNH 1008, squawk 6522, G-ABCD
	 G-CD, correct

1.14.5 The ATS messages listed below are to be read back in full by the pilot/driver. If a readback is not received the pilot/driver will be asked to do so. Similarly, the pilot/driver is expected to request that instructions are repeated or clarified if any are not fully understood.

Taxi/Towing Instructions

Level Instructions

Heading Instructions

Speed Instructions

Airways or Route Clearances

Approach Clearances

Runway-in-Use

Clearance to Enter, Land On, Take-Off On, Backtrack, Cross, or Hold Short of any Active Runway

SSR Operating Instructions









Altimeter Settings

VDF Information

Frequency Changes

Type of ATS Service

Transition Levels

 G-ABCD, cleared to cross A1 at Wicken, maintain FL70 whilst in controlled airspace. Report entering the airway	 Cleared to cross A1 at Wicken, maintain FL70 in controlled airspace, Wilco, G-ABCD
 G-CD, hold position	 Holding, G-CD
 G-CD, contact Ground 118.050	 Ground on 118.050, G-CD
 BIGJET 347, Squawk 6402	 6402, BIGJET 347

1.14.6 Items which do not appear in the above list may be acknowledged with an abbreviated read back.

1.14.7 If an aircraft read back of a clearance or instruction is incorrect, the controller shall transmit the word 'NEGATIVE' followed by the correct version.

 G-CD, QNH 1003	 QNH 1013, G-CD
	 G-CD, Negative, QNH 1003
	 QNH 1003, G-CD

1.14.8 If at any time a pilot receives a clearance or instruction with which he cannot comply, he should advise the controller using the phrase 'UNABLE' (COMPLY) and give the reason(s).

 BIGJET 347, Wrayton climb FL280, cross Wicken FL150 or above	 Wrayton, BIGJET 347, unable cross Wicken FL150 due weight
--	---

1.14.9 When an amendment is made to a clearance the new clearance shall be read in full to the pilot and shall automatically cancel any previous clearance. Controllers must be aware, therefore, that if the original clearance included a restriction, e.g. "cross KTN FL150 or below" then the issue of a revised clearance automatically cancels the earlier restriction, unless it is reiterated with the revised clearance.

1.14.10 When any doubt exists as to whether a message containing critical information has been passed by the controller or received and understood by the pilot, the message must be repeated. Critical information is information, other than that required to enable routine flight, which must be received by pilots to ensure the safety and effective operation of their aircraft.

The following can be considered as examples of critical information:

- Low Visibility Procedures

- Windshear Warnings
- Essential Aerodrome Information
- Equipment serviceability (i.e. ILS/navigational aids)
- Weather hazards (thunderstorms, hail, icing, etc.)

1.15 Withholding Clearances

- 1.15.1 It may be considered expedient by Government to withhold an ATC clearance to aircraft, particularly if the aircraft has not entered UK national airspace. When authorised, the following phraseology is to be used.

 BIGJET 347, I am instructed by Her Majesty's Government to refuse entry into United Kingdom airspace. What are your intentions?

 BIGJET 347, I am instructed by Her Majesty's Government to inform you that landing clearance has been refused for any airfield within the United Kingdom. What are your intentions?

 BIGJET 347, I am instructed by Her Majesty's Government that you are to hold at KTN at FL270. Acknowledge

- 1.15.2 The Aerodrome Authority and certain other persons are empowered to prohibit flight and they may instruct a controller to withhold a clearance. If a controller has not been instructed to withhold clearance but has reason to believe that a planned flight is liable to endanger life or involve a breach of legislation, the controller is to warn the pilot of the hazardous condition or apparent infringement and obtain an acknowledgement of the message. The hazardous condition may be reported by an outside agency or observed by the controller. Because of possible legal action when pilots disregard the warnings described above, it is essential that clear and precise messages are passed to the pilots concerned and acknowledgements obtained. Further transmissions may be necessary to ascertain the intentions of the pilot.

 BIGJET 347, I am informed that there may be damage to the port wing tip of your aircraft. It appears that your planned flight is liable to endanger life. Acknowledge

 G-ABCD, you are advised surface wind 280 degrees 37 knots gusting 50. It appears that your planned flight is liable to endanger life. Acknowledge

- 1.15.3 In the case of an anticipated infringement of legislation the controller is to warn the pilot that if he does take-off the facts will be reported to the appropriate authority.

	G-ABCD, your planned flight appears to contravene legislation because the required minima for VFR flight are not present. If you take off I shall be required to report the facts. Acknowledge
---	---

1.16 Simultaneous Transmissions

- 1.16.1 Direct communications between pilots and ATSU's can be adversely affected by simultaneous transmissions which, effectively, block all or part of intended messages. Moreover, whilst the situation may be apparent to the controller or another pilot, the individuals who inadvertently make such transmissions may be unaware. On hearing a simultaneous transmission it can be helpful for the controller (or another pilot if it is the controller's transmission which has been blocked) to draw attention to the situation using the word 'blocked'.

- 1.16.1.1 Controller Example (where pilots have transmitted simultaneously):

	Transmission Blocked – (callsign if known) say again
---	--









- 1.16.1.2 Pilot Example (where another pilot has blocked a controller's transmission):

	Transmission Blocked – Wrayton say again, BIGJET 345
---	--

1.17 Complying with Clearances and Instructions

- 1.17.1 Pilots are expected to comply with clearances and instructions promptly, commensurate with normal aircraft operations. If, for any reason, a pilot does not wish to comply with an instruction promptly, the pilot should advise the ATS unit and give an indication of when he intends to comply.
- 1.17.2 If an ATS unit wishes to indicate that time of compliance is at the pilot's discretion, the ATS message will include the phrase 'when ready'.
- 1.17.3 If an ATS unit wishes to indicate that the clearance or instruction is required to be complied with at a particular point in the flight, the message will include the phrase 'after passing'.
- 1.17.4 If an ATS unit wishes to indicate that the instruction or clearance must be complied with at once, the controller's message will include the word 'now' or 'immediately'. Use of the word 'now' indicates that the instruction should be complied with in accordance with normal aircraft operating procedures, but without delay. Use of the word 'immediately' indicates a further degree of urgency exists (e.g. to avoid flight into terrain or restricted airspace, or for the provision of collision avoidance, see Chapter 5 Paragraph 1.6.4 Avoiding Action Phraseology). In such circumstances, the pilot should take action to comply with the instruction as soon as practicable, subject to the safety of the aircraft.

- 1.17.5 In order to ensure any restriction is not blocked by a pilot acknowledgement, the phrase or word, indicating when a clearance or instruction should be complied with, will normally be placed before the executive instruction (Paragraph 1.17.6, 1st and 2nd examples), but in certain cases the phrase or word may be placed between the instruction and the value of the instruction (Paragraph 1.17.6, 3rd and 4th examples).
- 1.17.6 The phrases and words described in this section are most commonly used in association with level instructions (see also Chapter 3, Level Reporting, Paragraph 1.2), but may be used in other circumstances if appropriate. Examples are shown below:

 BIGJET 347, <i>after passing</i> North Cross, descend FL80	 <i>After passing</i> North Cross, descend FL80, BIGJET 347
 BIGJET 347, <i>when ready</i> descend FL170, Report leaving FL210	 <i>When ready</i> descend FL170. Report leaving FL210, BIGJET 347
 BIGJET 347, reduce speed <i>now</i> 210 kt	 Reducing speed <i>now</i> 210 kt, BIGJET 347
 BIGJET 347, climb <i>immediately</i> FL35	 Climbing <i>immediately</i> FL35, BIGJET 347

1.18 **Communication Failure**

1.18.1 **Air – Ground**

- a) Check the following points:
 - i) The correct frequency has been selected for the route being flown.
 - ii) The Aeronautical Station being called is open for watch.
 - iii) The aircraft is not out of radio range.
 - iv) Receiver volume correctly set.
- b) If the previous points are in order it may be that the aircraft equipment is not functioning correctly. Complete the checks of headset and radio installation appropriate to the aircraft.
- c) When an aircraft station is unable to establish contact with the aeronautical station on the designated frequency it shall attempt to establish contact on another frequency appropriate to the route being flown. If this attempt fails, the aircraft station shall attempt to establish communication with other aircraft or other aeronautical stations on frequencies appropriate to the route.
- d) The pilot may still be unable to establish communication on any designated aeronautical station frequency, or with any other aircraft. The pilot is then to transmit his message twice on the designated frequency, including the addressee for whom the message is intended, preceded by the phrase 'TRANSMITTING BLIND' in case the transmitter is still functioning.
- e) Where a transmitter failure is suspected, check or change the microphone. Listen out on the designated frequency for instructions. It should be possible to answer questions by use of the carrier wave if the microphone is not functioning (see Chapter 8 paragraph 1.7.1).

- f) In the case of a receiver failure transmit reports twice at the scheduled times or positions on the designated frequency preceded by the phrase 'TRANSMITTING BLIND DUE TO RECEIVER FAILURE'.
- g) An aircraft which is being provided with air traffic control service, advisory service or aerodrome flight information service is to transmit information regarding the intention of the pilot in command with respect to the continuation of the flight. Specific procedures for the action to be taken by pilots of IFR and Special VFR flights are contained in the appropriate AIP ENR and/or AD sections.

1.18.2 **Ground – Air**

1.18.2.1 After completing checks of ground equipment (most airports have standby and emergency communications equipment) the ground station will request other aeronautical stations and aircraft to attempt to communicate with the aircraft which has failed to maintain contact.

1.18.2.2 If still unable to establish communication the aeronautical station will transmit messages addressed to the aircraft by blind transmission on the frequency on which the aircraft is believed to be listening.

1.18.2.3 These will consist of:

- a) The level, route and EAT (or ETA) to which it is assumed the aircraft is adhering.
- b) The weather conditions at the destination aerodrome and suitable alternate and, if practicable, the weather conditions in an area or areas suitable for descent through cloud procedure to be effected. (See AIP ENR Section.)

1.19 **Test Transmissions**

1.19.1 All radio transmissions for test purposes shall be of the minimum duration necessary for the test and shall not continue for more than 10 seconds. The recurrence of such transmissions shall be kept to the minimum necessary for the test.

1.19.2 The nature of the test shall be such that it is identifiable as a test transmission and cannot be confused with other communications. To achieve this the following format shall be used:

- the callsign of the aeronautical station being called;
- 'the aircraft identification';
- the words 'RADIO CHECK';
- 'the frequency' being used;

1.19.3 The operator of the aeronautical radio station being called will assess the transmission and will advise the aircraft making the test transmission in terms of the readability scale (Table 11), together with a comment on the nature of any abnormality noted (i.e. excessive noise) using the following format:

- 'the aircraft identification';
- 'the callsign' of the aeronautical station replying;
- 'READABILITY x' (where 'x' is a number taken from Table 11);
- 'additional information' with respect to any noted abnormality;

NOTE: For practical reasons it may be necessary for the operator of an aeronautical station to reply with 'STATION CALLING (*frequency or 8.33 channel*) UNREADABLE'.

Table 11

Readability Scale	Meaning
1	Unreadable
2	Readable now and then
3	Readable but with difficulty
4	Readable
5	Perfectly readable

 Borton Tower, G-ABCD, radio check
118.725

 G-ABCD, Borton Tower, readability 5

or,

 G-CD, Borton Tower, readability 3 with
a loud background whistle

or,

 Station calling Borton Tower
readability 1

1.20 Pilot Complaints Concerning Aeronautical Telecommunications

Pilots should report faults concerning services and facilities in the Aeronautical Mobile Broadcast and Navigation Services to the Briefing Officer, Senior Telecommunications Officer or Senior Controller at the destination or airport of first landing in order that remedial action can be taken. Reports of local unserviceabilities will be forwarded to the Telecommunications staff if received on RTF by the ATSU.

1.21 Air Traffic Service Complaints Concerning Aircraft Communications

Aircraft radio faults including technical failure, incorrect operating procedures and misuse of specific radio channels may result in the aircraft operator receiving a communication from the CAA detailing the fault condition inviting the operator to explain and/or state what corrective action has been taken.

1.22 Hours of Service and Communications Watch

- 1.22.1 The hours of service of the radio facilities available in the United Kingdom are published in the UK AIP (ENR and AD) which also details those periods set aside for maintenance.
- 1.22.2 Aircraft stations shall, if possible, communicate directly with the ATSU appropriate to the area in which the aircraft are flying. If unable to do so, aircraft stations shall use any relay means available and appropriate to transmit messages to the ATSU.
- 1.22.3 When normal communications from an aeronautical station to an aircraft station cannot be established, the aeronautical station shall use any relay means available and appropriate to transmit messages to the aircraft station.
- 1.22.4 When an aircraft has established communication with an ATSU it is required to maintain a listening watch with that ATSU and advise the ATSU when the listening watch is about to cease. Aircraft should not cease to maintain a listening watch, except for reasons of safety, without informing the ATSU concerned. A time at which it is expected that the watch will be resumed must be stated.

1.23 Record of Communications

All ATC units have automatic equipment to record air-ground communications and some other ATS units (e.g. AFIS) also have such equipment.

1.24 Categories of Message

The categories of messages handled by the aeronautical mobile service are in the following order of priority:

- | | | |
|---|---|---------------------------------------|
| a) Distress messages | } | See Chapter 8 – Emergency Phraseology |
| b) Urgency messages | | |
| c) Communications relating to direction finding | | See Chapter 6 paragraph 1.7 |
| d) Flight safety messages | | See Chapter 9 paragraph 1.6 |
| e) Meteorological messages | | See Chapter 4 paragraph 7 |
| f) Flight Regularity messages | | See Chapter 9 paragraph 1.6. |

Chapter 3 General Phraseology

1 General













1.1 Introduction

- 1.1.1 The phraseology detailed in this manual has been established for the purpose of ensuring uniformity in RTF communications. Communications shall be concise and unambiguous, using standard phraseology for all situations for which it is specified. Obviously, it is not practicable to detail phraseology examples suitable for every situation. However, if standard phrases are adhered to when composing a message, any possible ambiguity will be reduced to a minimum. Only when standard phraseology cannot serve an intended transmission, shall plain language be used.
- 1.1.2 Some abbreviations, which by their common usage have become part of aviation terminology, may be spoken using their constituent letters rather than the spelling alphabet, for example, ILS, QNH, RVR, etc., (see Chapter 1, paragraph 1.2).
- 1.1.3 For all transmissions, with the exception of those used for surveillance radar approaches or precision radar approaches, the word 'degrees' shall be appended to heading figures where the heading ends in zero, or in cases where confusion or ambiguity may result.
- 1.1.4 For all transmissions, the word 'millibar' shall be appended to figures when transmitting a pressure setting below 1000 mb, or in cases where confusion or ambiguity may result.
- 1.1.5 The following words may be omitted from transmissions provided that no confusion or ambiguity may result:
- 'Surface' and 'knots' in relation to surface wind direction and speed.
 - 'Degrees' in relation to surface wind direction.
 - 'Visibility', 'cloud' and 'height' in meteorological reports.
 - 'over', 'Roger' and 'out'.
- 1.1.6 The excessive use of courtesies should be avoided.

1.2 Level Reporting

- 1.2.1 Only basic level instructions are detailed in this Chapter. More comprehensive phrases are contained in subsequent Chapters in the context in which they are most commonly used.
- 1.2.2 The precise phraseology used in the transmission and acknowledgement of climb and descent clearances will vary, depending upon the circumstances, traffic density and nature of the flight operations.
- 1.2.3 However, care must be taken to ensure that misunderstandings are not generated as a consequence of the phraseology employed during these phases of flight. For example, levels may be reported as altitude, height or flight levels according to the phase of flight and the altimeter setting. Therefore, when passing level messages, the following conventions apply:
- The word 'to' is to be omitted from messages relating to FLIGHT LEVELS.
 - All messages relating to an aircraft's climb or descent to a HEIGHT or ALTITUDE employ the word 'to' followed immediately by the word HEIGHT or ALTITUDE. Furthermore, the initial message in any such RTF exchange will also include the appropriate QFE or QNH.

















- c) The phrase 're-cleared' should not be employed.
- d) When transmitting messages containing flight levels each digit shall be transmitted separately. However, in an endeavour to reduce 'level busts' caused by the confusion between some levels (100/110, 200/220 etc.), levels which are whole hundreds e.g. FL100, 200, 300 shall be spoken as "Flight level (number) HUN DRED". The word hundred must not be used for headings.

 G-CD, report your level	 G-CD, maintaining FL65
	 G-CD, descend FL45
	 Descend FL45, G-CD
 G-CD, report your level	 G-CD, maintaining altitude 2500 feet Wessex 998 millibars
	 G-CD, descend to altitude 2000 feet Borton QNH 1000
	 Descend to altitude 2000 feet Borton QNH 1000, G-CD
	 G-CD, descend to altitude 1500 feet
	 Descend to altitude 1500 feet, G-CD
	 G-CD, descend to height 1000 feet QFE 997 millibars
	 Descend to height 1000 feet QFE 997 millibars, G-CD



- NOTES:**
- 1 Use of the word 'millibars' for pressures lower than 1000
 - 2 Transmission of Regional Pressure Setting (Wessex) limited to regional name and pressure.

1.2.3.1 In the following examples the operations of climbing and descending are interchangeable and examples of only one form are given.





 G-CD, report passing FL80	 Wilco, G-CD
---	---

	 G-CD, passing FL80
 G-CD, maintain altitude 2500 feet	 Maintaining altitude 2500 feet, G-CD
 G-CD, climb FL70	 Climb FL70, G-CD
	 G-CD, reaching FL70
 G-CD, request descent	 G-CD, descend FL60
	 Descend FL60, G-CD
 G-CD, not below FL60	 Not below FL60, G-CD
 BIGJET 347, after passing North Cross descend FL80	 After passing North Cross descend FL80, BIGJET 347
 BIGJET 347 stop descent at FL210	 Stop descent at FL210 BIGJET 347
 BIGJET 347, descend FL150, level by South Cross	 Descend FL150 level by South Cross, BIGJET 347
 BIGJET 347, climb FL290, level at time 55	 Climb FL290, level at time 55, BIGJET 347



1.2.3.2 Where the controller requires the aircraft to achieve a specific rate of climb or descent, the controller shall use the phraseology shown below.

 BIGJET 347, climb at 1000 feet per minute or greater	 Climb at 1000 feet per minute or greater, BIGJET 347
 BIGJET 347, descend at 500 feet per minute or less	 Descend at 500 feet per minute or less, BIGJET 347

1.2.3.3 Exceptionally, a best rate of climb or descent may be required. Pilots of aircraft operating within controlled airspace in the London and Scottish FIRs have been instructed not to operate with a climb or descent rate in excess of 8000 ft/min. Aircraft in an emergency and certain military activities are exempt from this restriction.





 BIGJET 347, expedite descent FL180	 Expedite descent FL180, BIGJET 347
 BIGJET 347, climb FL280 expedite until passing FL180	 Climb FL280 expedite until passing FL180, BIGJET 347
or,	
 BIGJET 347, unable expedite climb due weight	

1.2.3.4 Under exceptional circumstances, if instant descent/climb is required, the word 'immediately' shall be used.

 BIGJET 347, descend immediately FL200 due traffic	 Descend immediately FL200, BIGJET 347
---	---

1.2.3.5 **Pilots are expected to comply with ATC instructions as soon as they are issued.** However, when a climb/descent is left to the discretion of the pilot, the words 'when ready' shall be used.

1.2.3.6 Except as described in paragraph 1.4, a pilot receiving a Radar Control Service is not required to report leaving a level, passing a level, or reaching a level, unless specifically requested to do so.

 BIGJET 347, when ready climb FL280, report leaving FL200	 When ready climb FL280, wilco, BIGJET 347
	 BIGJET 347, leaving FL200 climbing FL280
	 BIGJET 347, Roger

















1.2.4 When pilots are instructed to report leaving a level, they should advise ATC that they have left an assigned level only when the aircraft's altimeter indicates that the aircraft has actually departed from that level and is maintaining a positive rate of climb or descent, in accordance with published procedures.

1.2.5 To avoid excessive delays to traffic when ATS surveillance systems are not available, controllers may authorise an aircraft to climb or descend in VMC, subject to a number of safeguards, including the pilot agreeing to maintain his own separation from other aircraft.

 BIGJET 347, maintaining own separation and VMC descend FL50

1.3 Speed Control

1.3.1 Controllers may instruct pilots to increase/decrease speed in order to maintain the appropriate separation.

 BIGJET 347, reduce speed to Mach 0.7	 Reduce speed to Mach 0.7, BIGJET 347
 BIGJET 347, maintain present speed	 Maintain present speed, BIGJET 347
 BIGJET 347, maintain 250 knots or greater	 Maintain 250 knots or greater, BIGJET 347
 BIGJET 347, not above 250 knots	 Not above 250 knots, BIGJET 347
 BIGJET 347, reduce to minimum clean speed	 Reduce to minimum clean speed, BIGJET 347
 BIGJET 347, reduce to minimum approach speed	 Reduce to minimum approach speed, BIGJET 347
 BIGJET 347, maintain 160 knots until 4 miles final	 Maintain 160 knots until 4 miles final, BIGJET 347
 BIGJET 347, maintain 160 knots until outer marker	 Maintain 160 knots until outer marker, BIGJET 347

1.3.2 The following phraseology shall be used by controllers when providing speed control to aircraft at or above FL280 that have been cleared to levels below FL280.

1.3.2.1 Where the controller only requires speed control to apply following the point at which the aircraft changes over from Mach number to IAS, the phraseology to be used by the controller is:

 BIGJET 347, descend FL120, on speed conversion, 250 knots	 Descend FL120, on speed conversion, 250 knots, BIGJET 347
---	---

1.3.2.2 Where the controller requires the aircraft to fly at a specific Mach number until the changeover to IAS and then fly a specified IAS, the phraseology to be used by the controller is:

 BIGJET 347, Mach .78, on speed conversion, 250 knots
--

- 1.3.2.3 Where the controller requires the aircraft to fly the specified IAS as soon as practicable, the phraseology to be used by the controller is:

	BIGJET 347, when able, speed 250 knots
---	--

- 1.3.2.4 The procedures above may be used in reverse for the application of speed control to aircraft currently below FL280 but climbing to a level above FL280.

	BIGJET 347, on speed conversion, Mach .7
---	--

	BIGJET 347, 250 knots, on speed conversion, Mach .7
---	---

	BIGJET 347, maintaining own separation and VMC descend FL50
---	---

1.4 Initial Call – IFR flights

1.4.1 Format of Initial Calls

Pilots of aircraft flying Instrument Departures (including those outside controlled airspace) shall include the following information on initial contact with the first en-route ATS Unit (see also Chapter 6 Approach Phraseology Paragraph 1.1.2):

- a) Callsign;
- b) SID or Standard Departure Route Designator (where appropriate);
- c) Current or passing level; **PLUS**
- d) Initial climb level (i.e. the first level at which the aircraft will level off unless otherwise cleared. For example, on a Standard Instrument Departure that involves a stepped climb profile, the initial climb level will be the first level specified in the profile).

	Westbury Departure, BIGJET 347, BIGRO 5D, Passing Altitude 2300 feet climbing FL80
---	--

	BIGJET 347, Westbury, Roger
---	-----------------------------

1.4.2 Subsequent Frequency Changes

Unless otherwise instructed or paragraph 1.4.1 applies, when changing communication channel to an ATC unit (including changes within the same ATS unit), the initial call on the new channel shall include **aircraft identification and level only**.

	Westbury Control, BIGJET 347, FL 350
---	--------------------------------------

	BIGJET 347, Westbury, Roger
---	-----------------------------

1.4.3 Level information should be included in the report as follows:

- a) if the aircraft is in level flight but cleared to another level, the call shall include the aircraft identification followed by the **current level and the cleared level**;

 Westbury Approach, BIGJET 347,
Maintaining FL350 cleared FL250

 BIGJET 347, Westbury, Roger

- b) if the aircraft is not in level flight, the call shall include the aircraft identification followed by **cleared level only**;

 Westbury Approach, BIGJET 347,
descending FL90

 BIGJET 347, Westbury, Roger

- c) if the aircraft has been assigned a speed or a heading, the initial call shall also include the assigned speed or heading.

 Westbury Control, BIGJET 347,
FL 90, Maintaining 250 kt

 BIGJET 347, Westbury, Roger

1.5 Initial Call – VFR Flight

1.5.1 Normally, the initial call to an ATS unit should only include the minimum information needed to establish:

- a) the service that an enroute flight requires; or
b) the clearance/information that a joining or departing flight requires.

 Westbury Approach, G-ABCD,
Request (type of service)

 Westbury Tower, G-ABCD, Request
join

 Westbury Tower, G-ABCD, Request
taxi for departure to Borton

 Westbury Tower, G-ABCD, Request
taxi for the south side maintenance
area

 Westbury Tower, G-ABCD, Request
zone transit

The ATS unit will then respond with their callsign and 'Pass Your Message' (optional).

1.6 Passing Message Details

1.6.1 Flights on or in the vicinity of an aerodrome

Pilots of aircraft inbound or outbound to an aerodrome, or wishing to manoeuvre on an aerodrome, when instructed to pass their message details, should respond in the manner described in Chapter 4.

1.6.2 En-route flights

Generally, the format of this call is applicable to aircraft operating under Visual Flight Rules (VFR). However, aircraft operating under Instrument Flight Rules (IFR), when contacting an ATS unit that does not hold details of the flight, may use the format described in Paragraph 1.6.3.

1.6.3 When instructed by the ATS Unit to pass your message details, the reply should contain the following information, whenever possible in the order specified:

a) Aircraft Callsign / Type





b) Departure Point and Destination

c) Present Position





d) Level

e) Additional details / Intention (e.g. Flight Rules, Next route point)

Reply Example 1:

 Westbury Approach, G-ABCD, request Basic Service	 G-ABCD, Westbury Approach
 G-ABCD, Cessna 172, from Borton to Walden, 15NM South of Westbury, altitude 2500 feet Wessex 1008, VFR, tracking to Wells	 G-CD Roger, Basic Service, Report Wells
 Basic Service, Wilco, G-CD	

Reply Example 2: An aircraft returning to the aerodrome of departure.

 Westbury Approach, G-ABCD, request Basic Service	 G-ABCD, Westbury Approach, pass your message
 G-ABCD, PA28 local flight from Borton, Wells altitude 3500 feet Wessex 1008, VFR, tracking to Salisbury	 G-CD Roger, Basic Service, traffic is a Cessna 172, 15NM South of Westbury, VFR, tracking to Wells at 2500 feet, Report Salisbury
 Wilco, G-CD	

1.7 Position Reporting

1.7.1 Position reports shall contain the following elements of information:



a) Aircraft identification



b) Position

c) Time



d) Level

e) Next position and ETA

 BIGJET 347, Wicken 47 FL280 Marlow 57	 BIGJET 347
 G-ABCD, Wrayton Information report mid-channel	 Wilco, G-ABCD

 G-ABCD, mid-channel 25 Altitude 3500 Greenpoint 40	 G-ABCD
--	--

- 1.7.2 Where adequate flight progress data is available from other sources, such as ground radar, aircraft may be exempted from the requirement to make compulsory position reports.

 BIGJET 347, next report at Colinton	 Wilco, BIGJET 347
---	---



 BIGJET 347, omit position reports	 Wilco, BIGJET 347
---	---

 BIGJET 347, omit position reports this frequency	 Wilco, BIGJET 347
--	---

 BIGJET 347, resume position reporting	 Wilco, BIGJET 347
---	---

1.8 Flight Plans



- 1.8.1 A pilot may file a flight plan with an ATSU during flight, although the use of busy RTF channels should be avoided; normally the FIS frequency should be used.

 Wrayton Control, G-ABCD, I wish to file an airborne flight plan	 G-ABCD, Wrayton Control, pass your message
---	--

- 1.8.2 The format for an airborne flight plan is as follows:

- a) Aircraft identification and type.
- b) Position and heading.
- c) Level and flight conditions.
- d) Departure aerodrome.
- e) Estimated time at entry point.
- f) Route and point of first intended landing.
- g) True airspeed.
- h) Desired level on airway or advisory route.

- 1.8.3 Where the aircraft pilot is responsible for activating a flight plan, this may be done by asking an ATSU by radio to activate the flight plan.

 G-CD, departed Seton at 38 request activate flight plan	 G-CD, departure time 38 will activate flight plan
---	---

1.8.4 During a flight a pilot may elect to cancel an IFR flight plan.

 Wrayton Control, G-CD, cancelling my IFR flight

 G-CD, Roger, IFR flight cancelled at 47

1.8.5 When a pilot has expressed his intention to cancel an IFR flight plan, the ATSU will pass the pilot any available meteorological information which makes it likely that flight in VMC cannot be maintained.

 G-CD, IMC reported in the vicinity of Kennington

 G-CD, Roger, remaining IFR

1.9 Low Visibility Procedures

1.9.1 Aerodromes that wish to continue operating in poor visibility or are available for instrument approaches in conditions of low cloud are required to develop and maintain Low Visibility Procedures (LVP). Controllers shall advise pilots of the implementation and subsequent cancellation of LVP at an aerodrome.

 BIGJET 347, LVPs in force

 Roger, BIGJET 347

 All stations, LVPs cancelled

1.10 Delays

1.10.1 Where an aircraft is required to hold before making an approach the expected delay shall be passed to the pilot.

 BIGJET 347, delay less than 10 minutes. Expect two holding patterns

1.10.2 Expected Approach Time (EAT) is the time that Approach Control estimate that an aircraft will be able to leave the holding facility, following a delay, to commence its approach to land.

 BIGJET 347, expect approach clearance at 44

1.10.3 If for reasons other than weather, e.g. an obstruction on the runway, the extent of the delay is not known, aircraft are to be advised "delay not determined" followed by the reason for the delay.

 BIGJET 347, delay not determined, runway obstructed

- 1.10.4 If aircraft elect to hold for the weather to improve at the landing aerodrome, the controller shall inform the first aircraft entering the holding pattern that "no traffic delay expected". Subsequent aircraft will be passed "delay not determined" followed by an indication of the number of aircraft holding.

 BIGJET 347, no traffic delay expected

 BIGJET 347, delay not determined 2 aircraft holding for weather improvement

INTENTIONALLY LEFT BLANK

Chapter 4 Aerodrome Phraseology

1 Aerodrome Control Service Phraseology

1.1 Introduction

- 1.1.1 Concise and unambiguous phraseology used at the correct time is vital to the smooth, safe and expeditious running of an aerodrome and associated ATZ. It is not only the means by which instructions and information are passed but it also assists pilots in maintaining an awareness of other traffic in their vicinity, particularly in poor visibility conditions.
- 1.1.2 Messages will not be transmitted to an aircraft during take-off, the last part of final approach or the landing roll, unless it is necessary for safety reasons, because it will be distracting to the pilot at a time when the cockpit workload is often at its highest.
- 1.1.3 Local procedures vary from aerodrome to aerodrome and it is impossible to give examples to cover every situation which may arise at the multiplicity of different types of aerodrome. Information in addition to that shown in the examples, e.g. time checks, etc. may be provided as necessary.

1.2 Type of Service

- 1.2.1 As described in Chapter 2 the type of service provided at an aerodrome falls into one of three categories. In this section the examples are confined to those used by air traffic controllers.
- 1.2.2 Whilst the RTF procedures used by air traffic controllers form the main content of this publication, it should be noted that the phraseology used by FISOs and Air/Ground Communication Service operators is different from that used by controllers. Examples of phraseology for Flight Information Service Officers and Air/Ground Communication Service operators may be found in Chapter 4 sections 2 and 5 respectively.

1.3 Departure Information and Engine Starting Procedures

- 1.3.1 Where no ATIS is provided the pilot may ask for current aerodrome information before requesting start up.

 Stourton Ground, BIGJET 347, request departure information

 BIGJET 347, Stourton Ground, departure runway 32 wind 290 4, QNH 1008, temperature -2, dewpoint -3, RVR 550 550 600 metres

 Runway 32, QNH 1008, will call for start up, BIGJET 347

- 1.3.2 Requests to start engines are normally made to facilitate ATC planning and to avoid excessive fuel wastage by aircraft delayed on the ground. At certain aerodromes, along with the request, the pilot will state the location of the aircraft and acknowledge receipt of the departure ATIS broadcast identifying letter together with the QNH.

 Stourton Ground, BIGJET 347, stand 24 information Bravo, QNH 1022 request start up

 BIGJET 347, Stourton Ground, start up at time 35

- 1.3.3 When there will be a delay to the departure of the aircraft the controller will normally indicate a time to start up or expect to start up.

 Stourton Ground, BIGJET 347, information Charlie QNH 1022, request start up

 BIGJET 347, Stourton Ground, start up approved

or,

 BIGJET 347, Stourton Ground, expect start up at time 35

or,

 BIGJET 347, Stourton Ground, expect departure at time 49 start up at own discretion

1.4 Pushback and Powerback

At many aerodromes at which large aircraft operate, the aircraft are parked nose-in to the terminal in order to save parking space. Aircraft have to be pushed backwards by tugs before they can taxi for departure. Some aircraft also have the capability to reverse from a nose-in position to the terminal under their own power. This procedure is known as powerback. Requests for pushback or powerback are made to ATC depending on the local procedures.

 BIGJET 347, stand 27 request pushback/powerback

 BIGJET 347, pushback/powerback approved

or,

 BIGJET 347, negative. Expect one minute delay due B747 taxiing behind

















1.5 Taxi Instructions

- 1.5.1 Taxi instructions issued by a controller will always contain a clearance limit, which is the point at which the aircraft must stop, unless further permission to proceed is given. For departing aircraft, the clearance limit will normally be the holding point of the runway in use, but it may be any other position on the aerodrome depending on the prevailing traffic. Taxi clearances should, wherever possible, be noted down by pilots.

 Borton Tower, G-ABCD, T67 by the south side hangars request taxi for VFR flight to Walden, 2 POB

 G-ABCD, taxi holding point G2 runway 24 via taxiway Charlie, QNH 967 millibars

NOTE: POB (total persons on board) may be added, e.g. where a flight plan is not required and has not been filed.

	 Taxi holding point G2 runway 24 via taxiway Charlie, QNH 967 millibars, G-ABCD
	 G-ABCD, request surface wind
	 G-CD, surface wind 220 6
	 G-CD, request runway 14
	 G-CD, after the Seneca coming from your left, taxi holding point B1 runway 14
	 Following the Seneca from the left, taxi holding point B1 runway 14, G-CD
 Borton Tower, G-ABCD, T67 at the fuel station VFR to Walden request taxi	 G-CD, runway 06, QNH 1008, taxi holding point B2 runway 14 via taxiway Alpha
	 QNH 1008, G-CD, request taxiway Bravo, and backtrack runway 06
	 G-CD, taxi holding point H1 runway 06 via taxiway Bravo
	 Taxi holding point H1 runway 06 via taxiway Bravo, G-CD
 Borton Tower, G-ABCD, at the fuel station request taxi to flying club	 G-CD, taxi holding point A1 runway 24 via Charlie
	 Taxi holding point A1 runway 24 via Charlie, G-CD
	 G-CD, holding point A1 runway 24 request cross
	 G-CD, negative. Hold position.
	 Holding, G-CD



G-CD, taxi to the flying club, via A1
cross runway 24 report vacated



Taxi to the flying club, via A1 cross
runway 24, Wilco, G-CD



G-CD, runway vacated



G-CD

- NOTES:**
- 1 Instruction to report vacated may be omitted when aerodrome control has continuous sight of the aircraft crossing.
 - 2 For helicopters the phrase "Air-taxi..." may be used in place of "Taxi..."

- 1.5.2 Controllers are not to instruct aircraft or vehicles to cross illuminated red stop-bars used at runway and intermediate taxiway holding positions. The aerodrome operator may decide, on the grounds of safety, that inoperable stop-bars and associated taxiways be withdrawn from service and alternative routes used where practicable. On the occasions when the withdrawal of inoperable stop-bars is not possible and the stop-bars cannot be readily suppressed, under exceptional circumstances, an aircraft may be instructed to cross such an illuminated stop-bar.



G-CD stop-bar unserviceable,
cross red stop-bar at A1



Cross red stop-bar at A1, G-CD



G-CD stop-bar unserviceable, cross
red stop-bar, via A1 line up runway
24



Cross red stop-bar, via A1 line up
runway 24, G-CD

- 1.5.3 If the instructions given to surface traffic involve crossing a runway in use, clearance to cross should normally be withheld until no conflict exists. However, to achieve greater efficiency of operation, clearance to cross may be given subject to aircraft, which are landing or taking off. The conditional clearance shall contain sufficient information to enable the pilot of the taxiing aircraft or vehicle driver to identify the other traffic and should be related to one movement only.



BIGJET 347, after the landing
A320, via Bravo 1 cross runway 26,
report vacated



After the landing A320, via Bravo 1
cross runway 26, wilco, BIGJET 347



G-CD, after the landing PA28 cross
and report vacated



After the landing PA 28, cross, wilco,
G-CD

- 1.5.4 When a clearance to cross a runway in use is issued, a report vacated instruction shall be included. However, this instruction may be omitted when the controller has continuous sight of the aircraft or vehicle crossing.



G-CD, after the departing Seneca,
via Kilo 4 cross runway 02



After the departing Seneca, via Kilo
4 cross runway 02, G-CD

- 1.5.5 When passing taxi instructions that will position an aircraft to cross a runway the controller may, optionally, insert the phrase 'hold short of' prior to the runway designator. This phrase is intended to reinforce the need to stop at the holding point.



BIGJET 347, taxi holding point C3,
hold short of runway 36



Taxi holding point C3 hold short of
runway 36, BIGJET 347



BIGJET 347, cross runway 36, taxi
holding point A1, hold short of
runway 09



Cross runway 36, taxi holding point
A1, hold short of runway 09,
BIGJET 347

- 1.5.6 Where an ATIS broadcast is established the controller does not need to pass departure information to the pilot when giving taxi instructions. He will, however, check that the aircraft is in possession of the latest QNH.



BIGJET 347, information Bravo,
QNH 1020 request taxi



BIGJET 347, now information
Charlie, new QNH 1021, after the
B747 passing left to right taxi holding
point A1 runway 28



QNH 1021, after B747 left to right
taxi holding point A1 runway 28,
BIGJET 347

1.6 Pre-Departure Manoeuvring

- 1.6.1 Meticulous care has been taken to ensure that the phraseology which is to be employed during the pre-departure manoeuvres cannot be interpreted as a take-off clearance. This is to avoid any misunderstanding in the granting or acknowledgement of take-off clearances and the serious consequences that could result.

- 1.6.2 At busy aerodromes with a separate ground and tower function, aircraft are usually transferred to the tower frequency at or approaching the holding point.



BIGJET 347, contact Tower 118.9



Tower 118.9, BIGJET 347

- 1.6.3 It may be necessary for the controller to instruct the pilot to hold at a specified holding point. Where appropriate the controller should include the reason for the instruction.



BIGJET 347, hold at Bravo 2



Hold at Bravo 2, BIGJET 347







BIGJET 347, hold at Bravo 1, 2
aircraft to depart before you from
runway 20





Hold at Bravo 1, BIGJET 347



- 1.6.4 Many types of aircraft carry out engine checks prior to departure and are not always ready for take-off when they reach the holding point.

 G-CD, report ready for departure	 Wilco, G-CD
 G-CD, ready for departure	 G-CD, line up
	 Line up, G-CD

- 1.6.5 When line-up will take place at a position other than for a full-length runway departure the intermediate 'Holding Point' designator shall be included in the line-up instruction. Controllers may include the runway 'Holding Point' designator in any other line-up instruction when considered necessary.

 G-CD, ready for departure	 G-CD, via C2 line-up runway 28
	 G-CD, line-up via C2 runway 28

- 1.6.6 For reason of expedition, a controller may wish to line-up an aircraft for departure before conditions allow take-off.

 BIGJET 347, via holding point A1 line-up and wait runway 26, one aircraft to depart before you from holding point A2	 Via holding point A1 line-up and wait runway 26, number two for departure, BIGJET 347
--	---



1.7 Take-Off Clearance

- 1.7.1 Except in cases of emergency, messages will not be transmitted to an aircraft in the process of taking off or in the final stages of an approach and landing.
- 1.7.2 Controllers will use the following phraseology for take off.





 G-CD, cleared for take-off	 Cleared for take-off, G-CD
--	--

NOTE: The surface wind will be passed if there is a significant difference to that already passed.





- 1.7.3 The averaging period for wind observations is two minutes for reports used at an aerodrome for take-off and landing and for wind indicators in air traffic service units. The instantaneous surface wind should be available to be given to pilots on request particularly at aerodromes supporting primarily the operations of aircraft whose maximum total weight authorised is 5,700 kg or less. When a pilot requests the instantaneous surface wind, the word "instant" is to be inserted to indicate that the wind being reported is not the two minute average.

 G-CD, request instant wind	 G-CD, instant wind 270 7
--	--





- 1.7.4 A take-off clearance shall be issued separately from any other clearance message.
- 1.7.5 For traffic reasons a controller may consider it necessary for an aircraft to take off without any delay. Therefore, when given the instruction 'cleared for immediate take-off', the pilot is expected to act as follows:
- At the holding point: taxi immediately on to the runway and commence take-off without stopping the aircraft.
 - If already lined up on the runway: take-off without delay. Should an immediate take-off not be possible, the pilot is to advise the controller.

 BIGJET 347, cleared for immediate take-off	 Cleared for immediate take-off, BIGJET 347
 G-CD, Piper Cub 2 miles on final approach. Cleared for immediate take-off wind 240 8 knots	 Cleared for immediate take-off, G-CD

- 1.7.6 For reason of expedition a controller may wish to line-up an aircraft for departure before conditions allow take-off.

 BIGJET 347, line-up and wait – vehicle crossing upwind end of runway	 Line-up and wait, BIGJET 347
 BIGJET 347, cleared for take-off	 Cleared for take-off, BIGJET 347

- 1.7.7 In poor visibility the controller may prefix the clearance with the runway designator and request the pilot to report when airborne.

 BIGJET 347, runway 28 cleared for take-off report airborne	 Runway 28 cleared for take-off. Wilco, BIGJET 347
	 BIGJET 347, airborne
	 BIGJET 347, contact Radar 121.750
	 Radar 121.75, BIGJET 347

- 1.7.8 Conditional clearances are only to be provided subject to conditions specified by the relevant authority. Conditional phrases will not be used for movements affecting the active runway(s), except when the aircraft or vehicles concerned are seen by the controller and pilot. Conditional clearances are to relate to one movement only and, in the case of landing traffic, this must be the first aircraft on approach. A conditional instruction shall be given as follows:
- callsign;
 - the condition;
 - identification of subject of the condition;

d) the instruction.

 BIGJET 347, after the landing DC9, line up

 After the landing DC9 line up, BIGJET 347

1.7.9 When several runways are in use and/or there is any possibility that the pilot may be confused as to which one to use, the runway number will be stated prior to the clearance.

 BIGJET 347, runway 09 left cleared for take-off

 Runway 09 left cleared for take-off, BIGJET 347

1.7.10 Local departure instructions may be given prior to the take-off clearance. Such instructions are normally given to ensure separation between aircraft operating in the vicinity of the aerodrome.

 BIGJET 347, after departure track extended centre line

 After departure track extended centre line, BIGJET 347

 BIGJET 347, after departure climb straight ahead

 After departure climb straight ahead, BIGJET 347

 BIGJET 347, after departure fly heading 240 degrees, climb to altitude 6000 feet

 After departure fly heading 240 degrees, climb to altitude 6000 feet, BIGJET 347

 G-CD, after departure right hand circuit

 After departure right hand circuit, G-CD

 G-CD, after departure track 270 degrees from Borton until reaching altitude 3000 feet before setting course

 After departure track 270 degrees from Borton until reaching altitude 3000 feet before setting course, G-CD

1.7.11 Revised clearances and post departure instructions for aircraft on the runway or at the holding position shall be prefixed with an instruction to hold position.

 BIGJET 347, Hold position, after departure climb straight ahead to altitude 2500 feet QNH 1014 before turning right

 BIGJET 347, Holding, after departure climb straight ahead to altitude 2500 feet, QNH 1014 before turning right.

 BIGJET 347, Cleared for take-off

 Cleared for take-off, BIGJET 347

 G-CD, after departure request right turn

 G-CD, Hold position, right turn approved

 G-CD, Holding, right turn approved



G-CD, Cleared for take-off



Cleared for take-off, G-CD

- 1.7.12 Due to unexpected traffic developments or a departing aircraft taking longer to take-off than anticipated, it is occasionally necessary to rescind the take-off clearance or quickly free the runway for landing traffic.



BIGJET 347, take-off immediately or vacate runway



Taking-off, BIGJET 347



BIGJET 347, take-off immediately or hold short of runway



Holding, BIGJET 347

- 1.7.13 When an aircraft is about to take-off or has commenced the take-off roll, and it is necessary that the aircraft should abandon take-off, the aircraft will be instructed to cancel take-off or stop immediately; these instructions will be repeated.

G-CD, hold position, cancel take-off
I say again cancel take-off,
acknowledge

Holding, G-CD

BIGJET 347, stop immediately I say
again, BIGJET 347, stop
immediately, acknowledge

Stopping, BIGJET 347

NOTE: Military procedures for cancelled take-offs appear in Chapter 10 paragraph 3.4.

- 1.7.14 When a pilot abandons take-off he should, as soon as practicable, inform the tower that he is doing so. Likewise, as soon as practicable, he should inform the tower of the reasons for abandoning take-off if applicable, and request further manoeuvring instructions.



BIGJET 347, stopping



BIGJET 347

BIGJET 347, request backtrack for
another departure

BIGJET 347, backtrack approved

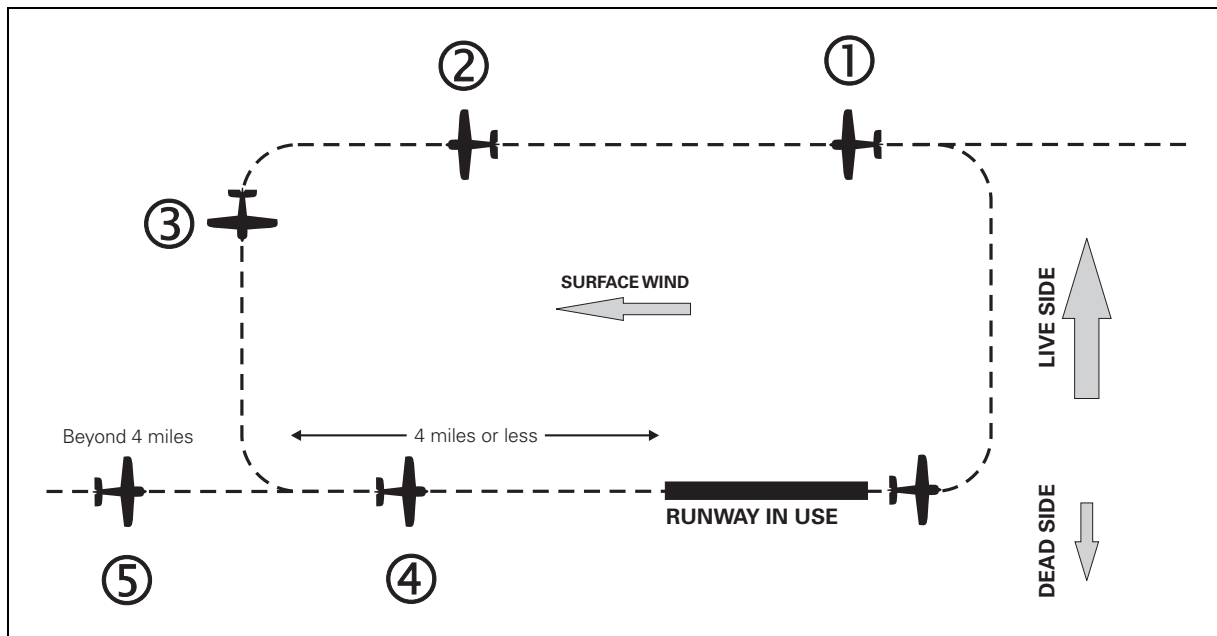
1.8 **Aerodrome Traffic Circuit**1.8.1 **Designated Positions in the Traffic Circuit****Figure 1** Designated positions in the traffic circuit**Typical Left-Hand Circuit**

Position 1 Aircraft reports on 'Downwind' leg.

Position 2 Aircraft reports '**Late downwind**' if it is on the downwind leg, has been unable to report '**Downwind**' and has passed the downwind end of the runway.

Position 3 Aircraft reports '**Base**' leg (if required).

Position 4 Aircraft reports '**Final**'. Clearance to land issued here.

Position 5 Aircraft reports '**Long final**' (between 8 and 4 miles) when aircraft is on a straight in approach.

NOTE 1: For light aircraft operations, circuit dimensions may be reduced but the relative RTF reporting points are maintained.

NOTE 2: For details of the standard overhead joining procedure see Aerodrome Traffic Circuit (Chapter 4 Paragraph 1.8.3) and RTF Reports at Unattended Aerodromes (Chapter 4 Paragraph 6.1).

NOTE 3: For details of military visual circuit patterns see Chapter 11 paragraph 1.4

1.8.2 Requests for circuit-joining instructions should be made in sufficient time for a planned entry into the circuit taking other traffic into account. Where ATIS is established, receipt of the broadcast should be acknowledged in the initial call to an aerodrome. When the traffic circuit is a right-hand pattern it shall be specified. A left-hand pattern **need not** be specified although it is **essential** to do so when the circuit direction is variable.

 Walden Tower, G-ABCD, request join

 G-ABCD, Walden Tower, pass your message

 G-ABCD, T67 10 miles south altitude 2500 feet Wessex 1008

 G-CD, join righthand downwind runway 27 height 1000 feet QFE 1006

 Join righthand downwind runway 27 height 1000 feet QFE 1006, G-CD

1.8.3 In some circumstances, an aircraft may be instructed to complete a standard overhead join which comprises the following:

- a) Overfly at 2000 ft above Aerodrome Elevation.
- b) If not already known, determine the circuit direction from the signals square, other traffic or windsock.
- c) Descend on the 'dead side' to circuit height.
- d) Join the circuit by crossing the upwind end of the runway at circuit height.
- e) Position downwind.

NOTE: Pilots should ensure they have checked beforehand whether specific joining procedures apply; otherwise an 'overhead join' (which actually takes a joining aircraft around the aerodrome) is the preferred method of joining the circuit pattern. Aerodromes where specific procedures apply will notify such differences in the UK AIP.

 G-CD, join overhead runway 20 height 2000 feet QFE 997 millibars, report aerodrome in sight

 Join overhead runway 20 height 2000 feet QFE 997 millibars, wilco, G-CD

1.8.4 Depending on prevailing traffic conditions and the direction from which an aircraft is arriving, it may be possible to make a straight-in approach.

 Walden Tower, G-ABCD, request join

 G-ABCD, Walden Tower, pass your message

 G-ABCD, T67 10 miles south altitude 2500 feet Wessex 1008 request straight in approach runway 34

 G-CD, cleared straight in approach runway 34 wind 260 degrees 5 knots QFE 1006 report final



 Cleared straight in approach runway 34 QFE 1006. Wilco, G-CD

1.8.5 The pilot having joined the traffic circuit makes routine reports as required by local procedures.









 G-CD, downwind

 G-CD, number 2 follow the Cherokee on base



 Number 2, Cherokee in sight, G-CD

 G-CD, base	 G-CD
 G-CD, final	 G-CD, runway 34 cleared to land wind 270 7
	 Runway 34 cleared to land, G-CD





1.8.6 Where necessary the controller may instruct the pilot to report at a specified position.

 G-CD, report overhead	 Wilco, G-CD
 G-CD, report downwind	 Wilco, G-CD
 G-CD, report long final	 Wilco, G-CD
 G-CD, report base	 Wilco, G-CD

1.8.7 It may be necessary in order to co-ordinate traffic in the circuit to issue delaying or expediting instructions.

 G-CD, extend downwind number 2 to a Cherokee 4 miles final	 Extend downwind, number 2, G-CD
 G-CD, for spacing orbit right report again on base	 Orbit right, Wilco, G-CD

1.8.8 In order to save taxiing time when flying training in the traffic circuit pilots may wish to carry out a 'touch and go', i.e. the aircraft lands, continues rolling and takes-off, without stopping.

 G-CD, downwind touch and go	 G-CD, report final
	 G-CD, final
	 G-CD, runway 34 cleared touch and go surface wind calm
	 Runway 34 cleared touch and go, G-CD

or,



G-CD, unable to approve due traffic,
make full stop landing runway 34
cleared to land, surface wind calm



Runway 34 cleared to land, G-CD

- 1.8.9 It is helpful for circuit management purposes if a controller is informed when an aircraft which has been engaged in multiple approaches is on his last circuit.



G-CD, downwind to land



G-CD, report final

1.9 Final Approach and Landing

- 1.9.1 A 'final' report is made when an aircraft has turned onto final approach. If the turn on is made at a distance greater than 4 NM from touchdown a 'long final' report is made. The landing/touch and go/low approach clearance will include the runway designation.



G-CD, final



G-CD, runway 34 cleared to land
surface wind 270 7



Runway 34 cleared to land, G-CD



BIGJET 347, long final



BIGJET 347, report final surface
wind 260 18



Wilco, BIGJET 347



BIGJET 347, final



BIGJET 347, runway 28 cleared to
land, wind 270 20



Runway 28 cleared to land,
BIGJET 347

NOTE 1: Military phraseology for a gear check appears in Chapter 10 paragraph 3.6.

NOTE 2: Where established, an 'outer marker' instead of a 'final' report may be made.

- 1.9.2 Where a controller cancels a landing clearance but feels that a landing clearance will be re-issued in good time for the aircraft to make a safe landing, he should, if time permits, give the reason for cancelling the landing clearance.



BIGJET 347, continue approach,
cancel landing clearance (reason),
acknowledge



Landing clearance cancelled,
continuing approach, BIGJET 347

- 1.9.3 If available, the instantaneous surface wind should be provided to the pilot on request.



G-CD, runway 13 cleared to land,
instant surface wind 270 15

- 1.9.4 The runway may be obstructed when the aircraft makes its 'final' report at 4 NM or less from touchdown but is expected to be available in good time for the aircraft to make a safe landing. On these occasions, the controller will delay landing clearance.



G-CD, final



G-CD, continue approach, wind
270 5



Continue approach, G-CD

The controller may or may not explain why the landing clearance has been delayed but the instruction to 'continue' IS NOT an invitation to land and the pilot must wait for landing clearance or initiate a missed approach (see Chapter 4, paragraph 1.10.3).

- 1.9.5 A landing aircraft may be permitted to touch down before a preceding landing aircraft has vacated the runway provided that:

- the runway is long enough to allow safe separation between the two aircraft and there is no evidence to indicate that braking may be adversely affected;
- it is during daylight hours;
- the preceding landing aircraft is not required to backtrack in order to vacate the runway;
- the controller is satisfied that the landing aircraft will be able to see the preceding aircraft which has landed, clearly and continuously, until it has vacated the runway; and
- the pilot of the following aircraft is warned. (Responsibility for ensuring adequate separation rests with the pilot of the following aircraft.)



BIGJET 347, runway 28, land after
the B737, wind calm



Land after the B737, BIGJET 347

Military phraseology for clearances with an occupied runway is shown in Chapter 10 paragraph 3.24.

- 1.9.6 A pilot may request to fly past the control tower or other observation point for the purpose of visual inspection from the ground.

- 1.9.7 If the low pass is made for the purpose of observing the undercarriage, one of the following replies could be used to describe its condition but these examples are not exhaustive:

- landing gear appears down;
- right (or left, or nose) wheel appears up (or down);
- wheels appear up;
- right (or left, or nose) wheel does not appear up (or down).

- 1.9.8 A pilot may request permission to make a low approach along the runway, without intending to land.

 G-CD, request low approach

 G-CD, runway 34 cleared low approach

- 1.9.9 If the runway in use is occupied by aircraft or vehicles, an approaching aircraft may be cleared to carry out a low approach which includes a descent not below a specified height or altitude. The minimum height or altitude is defined in regulatory documentation and/or local instructions as appropriate. In such circumstances, the pilot is to be informed of the aircraft or vehicles on the runway.

- 1.9.9.1 The following example assumes an aircraft operating on QNH.

 BIGJET 347, request low approach

 BIGJET 347, runway 05 cleared low approach, not below altitude (number) feet, vehicle on runway

 Runway 05 cleared low approach, not below altitude (number) feet, BIGJET 347

- 1.9.9.2 Where the aircraft is known to be operating on QFE, the instruction is as follows.

 BIGJET 347, request low approach

 BIGJET 347, runway 05 cleared low approach, not below height (number) feet, vehicle on runway

 Runway 05 cleared low approach, not below height (number) feet, BIGJET 347

1.10 Missed Approach

- 1.10.1 Instructions to carry out a missed approach may be given to avert an unsafe situation. When a missed approach is initiated cockpit workload is inevitably high. Any transmissions to aircraft going around shall be brief and kept to a minimum.

 BIGJET 347, go around I say again go around, acknowledge

 Going around, BIGJET 347

- 1.10.2 An aircraft on an instrument approach is to carry out the published missed approach procedure and an aircraft operating VFR is to continue into the normal traffic circuit unless instructions are issued to the contrary.

- 1.10.3 In the event of missed approach being initiated by the pilot, the phrase 'going around' shall be used.













 G-CD, going around

 G-CD, Roger

- 1.10.4 Missed Approach Phraseology used by military controllers is shown in Chapter 10 paragraph 3.17.



1.11 Runway Vacating and Communicating After Landing

1.11.1 Unless absolutely necessary, controllers will not give taxi instructions to pilots until the landing roll is complete. Unless otherwise advised, pilots should remain on tower frequency until the runway is vacated.

 BIGJET 347, vacate left	 Vacate left, BIGJET 347
 BIGJET 347, when vacated contact Ground 118.350	 When vacated Ground 118.350, BIGJET 347
	 Kennington Ground, BIGJET 347, runway vacated
	 BIGJET 347, Kennington Ground, taxi to Stand 27 via taxiway Alpha
	 Taxi to Stand 27 via taxiway Alpha, BIGJET 347
 G-CD, taxi to the end, report runway vacated	 Taxi to the end, Wilco, G-CD
	 G-CD, runway vacated
	 G-CD, give way to the Cherokee on taxiway Alpha, taxi to the flying club
	 Give way to the Cherokee on taxiway Alpha, taxi to the flying club, G-CD

1.12 Essential Aerodrome Information

Essential Aerodrome Information is information regarding the manoeuvring area and its associated facilities which is necessary to ensure the safe operation of aircraft. Essential Aerodrome Information is passed to aircraft whenever possible prior to start-up or taxi and prior to the commencement of final approach.

 BIGJET 347, caution construction work at the end of Stand 37
 ... caution work in progress ahead north side of taxiway Alpha
 ... caution centre line taxiway lighting unserviceable

 ... caution PAPIs runway 27
unserviceable

 ... caution large flock of birds north of
runway 27 near centre taxiway

 ... message from aerodrome
authority, fire and rescue services
reduced. The aerodrome can only
accept aircraft up to and including
category (number)

1.13 **Arrestor Systems at Military Aerodromes**

- 1.13.1 Phraseology describing arrestor systems at military aerodromes appears in Chapter 10 paragraph 3.7.

2 Aerodrome Flight Information Service Phraseology

2.1 Introduction

- 2.1.1 Concise and unambiguous phraseology used at the correct time is vital to the smooth, safe and expeditious running of an aerodrome and associated ATZ. It is not only the means by which instructions and information are passed but it also assists pilots in maintaining an awareness of other traffic in their vicinity, particularly in poor visibility conditions.
- 2.1.2 Messages will not be transmitted to an aircraft during take-off, the last part of final approach or the landing roll, unless it is necessary for safety reasons, because it will be distracting to the pilot at a time when the cockpit workload is often at its highest.
- 2.1.3 Local procedures vary from aerodrome to aerodrome and it is impossible to give examples to cover every situation which may arise at the multiplicity of different types of aerodrome. Information in addition to that shown in the examples, e.g. time checks, etc. may be provided as necessary.

2.2 Type of Service

- 2.2.1 As described in Chapter 2 the type of service provided at an aerodrome falls into one of three categories. In this section the examples are confined to those used by Flight Information Service Officers (FISOs). Phraseology for air traffic controllers may be found in Chapter 4 paragraph 1 and that for Air/Ground Communication Service Operators in Chapter 4 paragraph 5.
- 2.2.2 Whilst the RTF procedures used by air traffic controllers form the main content of this publication it should be noted that the phraseology used by FISOs at aerodromes is different from that used by controllers. A FISO at an aerodrome provides a service to give information useful for the safe and efficient conduct of flights in the Aerodrome Traffic Zone. From the information received pilots will be able to decide the appropriate course of action to be taken to ensure the safety of flight. Generally, the FISO is not permitted to issue instructions or advice to pilots of his own volition. However, in granting or refusing permission under Rule 40 and 41 of the Rules of the Air, FISOs at aerodromes are permitted to pass instructions to vehicles and personnel operating on the manoeuvring area and information and instructions to aircraft moving on the apron and specific parts of the manoeuvring area. Elsewhere on the manoeuvring area and at all times in the air, information only shall be passed to pilots. Further details on the passing of instructions by FISOs at aerodromes are contained in CAP 410 Manual of Flight Information Services - Part B Aerodrome.
- 2.2.3 FISOs are also permitted to pass messages on behalf of other agencies and instructions from the aerodrome operator. If they do so, they will include the name of the agency so that pilots will be aware that the message comes from a legitimate source, e.g. 'Wrayton Control clears you to join ...'.
- 2.2.4 With the exception of issuing instructions to aircraft on the ground, FISOs are reminded that the service they provide is an information service relating to the ATZ and aerodrome. They must ensure that the information given to pilots is distinct and unambiguous, as pilots will use this information for the safe and efficient conduct of their flights.
- 2.2.5 A FISO may request pilots to make position reports e.g. downwind, final etc. These requests do not have the status of instructions, although it is expected that most pilots will comply.

- 2.2.6 From the instructions and information provided by the FISO to aircraft on the appropriate areas of the aerodrome, the pilot will be able to determine if it is safe to taxi. From the information provided by the FISO, the pilot will determine if it is safe to land, take-off or transit the ATZ. FISOs are not permitted to refuse entry into the ATZ when requested by a pilot. The aerodrome authority may decide that they will not permit an aircraft to land at their aerodrome and request that the FISO pass this message on. Such a message must be prefixed: 'Message from the aerodrome authority...' FISOs may **not** issue such messages of their own volition.
- 2.3 **AFIS Phraseology for Ground Movement, Take-off, Landing and Transit**
- 2.3.1 RTF messages transmitted on aviation VHF frequencies should normally comprise callsign and text as described earlier in this document.
- 2.3.2 Ground movement instructions are similar for aircraft, vehicles and tractors towing aircraft but the operative word in the message is 'taxi', 'proceed' and 'tow' respectively.





















Table 1

	Phraseology
Taxi Instructions prior to take off, after landing and other ground movement.	(Aircraft callsign) taxi holding point (designation) runway (designation) via (route), surface wind (number) degrees (number) knots, QNH/QFE (pressure) millibars, left/right hand circuit. (Aircraft callsign) taxi to stand (designation) via (route). (Aircraft callsign) taxi to (location). When necessary, detailed taxiing instructions e.g. turn left from the apron and take the first intersection right. (Aircraft callsign) after the (aircraft type) passing (e.g. left to right) taxi holding point (designation) runway (designation) surface wind (number) degrees (number) knots, QNH/QFE (pressure) millibars, left/right hand circuit. (Aircraft callsign) follow the (aircraft type) (position of aircraft). (Aircraft callsign) hold position. Note: FISOs are permitted to pass instructions to helicopters engaged in air taxiing. However, when the pilot reports ready to depart, the FISO shall pass information. For all inbound helicopters, information shall be passed until they land or reach the hover prior to air taxiing to the parking area. Thereafter, instructions shall be given until the helicopter touches down.
Aircraft at the holding point of runway to be used for departure ready for take-off	(Aircraft callsign) hold position. (Aircraft callsign) take off at your discretion, surface wind (number) degrees (number) knots. (Aircraft callsign) traffic is (traffic information) take off at your discretion, surface wind (number) degrees (number) knots. ** **Note: Pilots will notify the FISO of their intentions.
Aircraft at the holding point of runway to be used for departure ready for take-off with the possibility of requiring a backtrack	(Aircraft callsign) do you require to backtrack the runway? ** **Note: Pilots will notify the FISO of their intentions.

Table 1 (Continued)

Aircraft requiring a backtrack	(Aircraft callsign) report entering the runway. (Aircraft callsign) report lining up.** (Aircraft callsign) traffic is (traffic information) report entering the runway and lining up.** (Aircraft callsign) the runway is occupied (details of traffic). Report lining up.** (Aircraft callsign) the (aircraft type) has landed to vacate and there is a (aircraft type) on a 2 mile final. Report lining up.** (Aircraft callsign) backtrack as required, surface wind (number) degrees (number) knots, take off at your discretion.** **Note: Pilots will notify the FISO of their intentions.
Instructions for crossing runway in use	(Aircraft callsign) cross runway (designation) at (point of crossing). Report vacated.* (Aircraft callsign) cross, report vacated.* (Aircraft callsign) negative, hold position, I will call you. *‘Report vacated’ instructions may be omitted when the FISO has continuous sight of the vehicle or aircraft crossing.
When airborne	(Aircraft callsign) roger, report (downwind or position).
Aircraft wishes to transit the ATZ	(Aircraft callsign) (traffic and aerodrome information), report entering/overhead/leaving.
Aircraft wishes to enter the ATZ for landing	(Aircraft callsign) runway (designation) left/right hand circuit, surface wind (number) degrees (number) knots, QNH/QFE (pressure) millibars (traffic information and essential aerodrome information as appropriate).
Aircraft reports joining the circuit	(Aircraft callsign) roger, (traffic information) report downwind/base/final.
Aircraft reports final	<i>(If number 1 and runway is clear)</i> (Aircraft callsign) land/touch and go at your discretion, surface wind (number) degrees (number) knots. OR <i>(If aircraft has traffic ahead on final)</i> (Aircraft callsign) roger, (number) aircraft ahead on final. OR <i>(If the runway is occupied)</i> (Aircraft callsign) the runway is occupied (traffic information).
Aircraft expects Air Traffic Control Service	(Aircraft callsign) no ATC Service available. (TYPE OF SERVICE) only.

2.3.3 Examples of typical FISO/Pilot RTF exchanges are detailed below.

 G-ABCD, request taxi	 G-CD, taxi holding point C2, runway 06 via taxiway C, surface wind 060 10 knots, QNH 998 millibars, left hand circuit
	 Roger, taxi to holding point C2, runway 06 via taxiway C, QNH 998 millibars, G-CD
at the holding point...	
 G-CD, C2 Ready for departure	 G-CD, Hold position
	 Holding, G-CD
 G-CD, Take-off at your discretion, surface wind 270 degrees 15 knots	 Taking off, G-CD
 G-CD, Traffic is a Cessna 172 base leg, take off at your discretion, surface wind 270 15	 Taking off, G-CD
 G-CD, Via C2 take-off at your discretion, surface wind 270 15	 Via C2 taking off, G-CD
 G-CD, Do you require to backtrack the runway?	 Affirm, G-CD
	 G-CD, Traffic is a Cessna 172 base leg, via C2 report entering the runway and lining up
	 Holding, wilco, G-CD
 G-CD, Entering runway 27	 G-CD, Roger
	 G-CD, Lining up runway 27
	 G-CD, Take off at your discretion, surface wind 270 15



Taking off, G-CD



G-CD, Report downwind

In the circuit...



G-CD, Downwind to land

G-CD, Roger, traffic is a Cessna 172
base leg, report final

Wilco, G-CD



G-CD, Final

G-CD, Roger, Cessna 172 ahead on
final

Roger, G-CD

When the runway is available...

G-CD, Land at your discretion,
surface wind 050 10 knots

Roger, G-CD

After landing...

G-CD, after the Cessna 172 taxiing
right to left, taxi to the aero club, via
taxiway CharlieRoger, after the Cessna 172, taxi to
the aero club, via taxiway Charlie,
G-CD

3 Aerodrome Phraseology for Helicopters

3.1 Introduction

- 3.1.1 Rotary-wing flight characteristics mean that helicopter operations at aerodromes can differ significantly from fixed-wing operations. This section describes standard phraseology and procedures to address the different requirements for helicopter lifting, taxiing, taking-off and landing (including the approach and departure phases), particularly at aerodromes where rotary-wing and fixed-wing operations are integrated.
- 3.1.2 Standard phraseology should be used in all situations for which it is specified. When standardised phraseology cannot serve an intended transmission, plain language should be used. The use of plain language may further assist when describing rotary-wing aircraft manoeuvres. Care should be exercised to ensure that all parties involved achieve clear understanding.
- 3.1.3 The phraseology described in this section is intended for general use. However, the examples of taxiing phraseology describe communications specific to aerodromes at which ATC or AFIS is provided. Phraseology examples for take-off and landing are specific to communications at aerodromes with ATC.

3.2 Helicopter Callsigns

- 3.2.1 Aircraft callsigns to be used are described in Chapter 2 paragraph 1.8. Provision is made for the name of the aircraft manufacturer, or the aircraft model, to be used before the aircraft registration (in full or abbreviated form). If considered appropriate, the pilot or ATSU may replace manufacturer's name or aircraft model with the term 'Helicopter' where this may benefit the ATSU or other aircraft (see phraseology examples paragraphs 3.8.5 and 3.8.6).

Table 2

Full callsign	Abbreviation
Helicopter G-ABCD	Helicopter CD

3.3 Helicopter Phraseology for Taxiing

- 3.3.1 These procedures are for helicopters taxiing for departure, or after landing, or for general manoeuvring on the aerodrome. Phraseology and procedures for specific manoeuvring on the aerodrome, for example for training purposes, should be described in local procedures.
- 3.3.2 The term 'LIFT' shall describe a manoeuvre where the helicopter gets airborne and enters a 'HOVER'.
- 3.3.3 'HOVER' describes a manoeuvre where the helicopter holds position whilst airborne in ground effect, waiting to proceed. Hover allows spot/axial turns (i.e. about the central axis of the helicopter). When required, further instructions should subsequently be transmitted to permit the helicopter to proceed.
- 3.3.4 The term 'AIR TAXI' shall be used when it is necessary for a helicopter to proceed at a slow speed above the surface, normally below 20 knots and in ground effect (ICAO).
- 3.3.5 The instruction 'GROUND TAXI' shall be used for the movement of a helicopter, in contact with the surface of the aerodrome, under its own power. This could be required for a helicopter fitted with wheels, to reduce rotor downwash (ICAO).

- 3.3.6 An instruction to 'TAXI' leaves the pilot free to select the most appropriate method, either ground taxi or air taxi. Pilots and controllers should use the term AIR TAXI or GROUND TAXI when required to differentiate between air taxiing and ground taxiing (for helicopters equipped with wheels).

NOTE 1: Air taxiing helicopters at aerodromes where ATC and AFIS are provided will be issued with detailed taxi routes and instructions as appropriate to prevent collisions with other aircraft and vehicles. Helicopters are expected to follow procedures/routes on aerodromes appropriate to aeroplanes unless otherwise authorised.

NOTE 2: ATC and AFIS units will normally avoid issuing instructions that result in taxiing helicopters coming into close proximity with small aircraft or helicopters and will normally give consideration to the effect of turbulence from taxiing helicopters on arriving and departing light aircraft (ICAO).

- 3.3.7 For a helicopter taxiing, the instruction 'HOLD' shall indicate a requirement to come to a standstill.
- 3.3.7.1 A helicopter air taxiing and instructed to 'HOLD', may hold in the hover or may touch down and hold on the ground at the pilot's discretion. If touch down is not authorised, a helicopter may be instructed by the ATSU to 'HOLD IN THE HOVER'.
- 3.3.7.2 A helicopter ground taxiing and instructed to 'HOLD' shall hold on the ground, unless a hover manoeuvre is specifically authorised or requested by the ATS unit.
- 3.3.8 ATC and AFIS will normally avoid issuing a frequency change instruction to a single-pilot helicopter hovering or air taxiing. If required and whenever possible, control instructions from the next ATS unit will be relayed until the pilot is able to change frequency (ICAO).

3.4 Helicopter Phraseology for Take-Off and Landing (ATC only)

- 3.4.1 At aerodromes, helicopter take-offs and landings may not be restricted to designated runways or landing areas. With appropriate permission helicopters may take-off and land at any location on the aerodrome. At aerodromes with an air traffic control service, all movements are subject to the permission of the ATC unit.
- 3.4.2 At aerodromes with air traffic control service, when helicopters land or take-off on the manoeuvring area, and within sight of the VCR the terms 'CLEARED TO LAND' and 'CLEARED FOR TAKE-OFF' shall be used to authorise the manoeuvres.
- 3.4.3 At aerodromes with air traffic control service, when helicopters land or take-off at locations not on the manoeuvring area (e.g. apron, maintenance area, sites adjacent the aerodrome), or locations not in sight of the VCR, or unlit locations at night, the appropriate phrase 'LAND AT YOUR DISCRETION' or 'TAKE-OFF AT YOUR DISCRETION' shall be used to authorise the manoeuvres. Relevant traffic information on other aircraft (airborne or on the ground) shall also be passed.
- 3.4.4 The term 'TOUCH DOWN' shall be used to describe an aircraft (helicopter or fixed-wing) coming into contact with the surface in accordance with normal operation. A clearance to land leaves the pilot of a helicopter free to either enter a low hover, or to touch down, as appropriate.

3.5 Helicopter Hover Phraseology Examples (ATC and AFIS only)

 Borton Tower, G-ABCD, request lift

 G-ABCD, Borton Tower, lift and hover, surface wind 040 degrees 6 knots

3.6 Helicopter Taxiing Phraseology Examples (ATC and AFIS only)

3.6.1 Taxi Instruction

 Borton Tower, G-ABCD, request TAXI for departure runway 06

 G-ABCD, Borton Tower, TAXI holding point H1, runway 06, via taxiway Golf

 Taxi holding point H1 runway 06 via taxiway Golf, G-ABCD
Note: The use of 'taxi' indicates the pilot is free to air taxi or ground taxi at his/her discretion

3.6.2 Air Taxi Instruction (if required)

 Borton Tower, G-ABCD, request Air Taxi for departure runway 06

 G-CD, Borton, Air Taxi holding point H1, runway 06, via taxiway Golf

 Air Taxi holding point H1 runway 06 via taxiway Golf, G-CD

3.7 Ground Taxi Instruction (if required)

 Borton Tower, G-ABCD, request ground taxi for departure runway 06

 G-ABCD, Borton Tower, ground taxi holding point H1 runway 06 via taxiway Golf

3.8 Helicopter Take-Off and Landing Phraseology Examples (ATC only)

3.8.1 Take-off on the Runway

 G-CD, ready for departure

 G-CD, Runway 06, Cleared for take-off

 Cleared for take-off, G-CD

3.8.2 Landing on the Runway

 G-CD, final runway 06

 G-CD, Runway 06, Cleared to land, surface wind 060 10

 Cleared to land, G-CD



3.8.3 Take-off from a designated Helicopter Landing Area on the Manoeuvring Area

 G-CD, 'Area Whiskey' ready for departure



 G-CD, 'Area Whiskey' Cleared for take-off

 Cleared for take-off, G-CD







3.8.4 Landing at a designated Helicopter Landing Area on the Manoeuvring Area.

 G-ABCD, at the Power Station to land 'Area Whiskey'	 G-CD, 'Area Whiskey' Cleared to land, surface wind 060 10
	 Cleared to land, 'Area Whiskey', G-CD

3.8.5 Take-off from the Apron (or location not on the Manoeuvring Area) for a Direct Departure (i.e. not following the visual circuit for departure).

 Borton Tower, Helicopter G-ABCD, beside the south side hangars ready for direct departure to Walden	 Helicopter CD, Borton, direct departure, surface wind 060 10, QNH 997 millibars, no reported traffic, Take-off at your discretion
	 Taking-off, departing direct, QNH 997 millibars, Helicopter CD

3.8.6 Direct Arrival to the Apron (or location not on the Manoeuvring Area) for Landing.

 Borton Tower, Helicopter G-ABCD, 5 miles east inbound to land Eastern Apron	 Helicopter CD, Borton, route to the eastern apron via the Power Station, report at the Power Station wind 060 10 QNH 997 millibars, runway 06 in use
	 Route to Eastern Apron via the Power Station, wilco, QNH 997 millibars, Helicopter CD
 Helicopter CD, at the Power Station	 Helicopter CD, traffic is a C172 taxiing from Stand 8 for taxiway B, Land at your discretion, surface wind 060 10
	 Roger, Landing Eastern Apron, Helicopter CD

4 Aerodrome Phraseology for Vehicles (ATC and AFIS only)

4.1 Introduction

4.1.1 The expeditious movement of vehicles plays an essential supporting role in the operation of an aerodrome. Whenever possible the areas in which vehicles and aircraft operate are segregated. However, there are many occasions when vehicles need to move on the manoeuvring area either for maintenance purposes or in direct support of aircraft operations.

4.1.2 Procedures governing the movement of vehicles vary widely from aerodrome to aerodrome, but certain factors to be taken into account when driving on an aerodrome are common to all:

- a) in general, aircraft are by no means as manoeuvrable as ground vehicles;
- b) the visibility from an aircraft cockpit for ground movement purposes is often restricted compared with a vehicle.





Therefore when vehicles are operating in close proximity to aircraft, drivers should be extremely vigilant and comply with Rule 42/43 of the Rules of the Air and, if applicable, ATC instructions.

4.1.3 Correct RTF operating technique must be observed by all users. For all vehicles on the movement area, it is important that a continuous listening watch is maintained, not only in case of further instructions or information from the tower, but also so that drivers can be aware of the movements, and intended movements, of other traffic thereby reducing the risk of conflict.







4.1.4 **The examples that follow are applicable to air traffic controllers and FISOs at aerodromes only. Air/Ground Communication Service operators are not to pass instructions and must use the phraseology they would use for the movement of aircraft on the aerodrome.**

4.2 Movement Instructions

4.2.1 Drivers on first call should state the ground station they are calling, identify themselves by their vehicle call sign and state their position and intended destination. Where the planned route includes crossing a runway, this should be included in the initial call.



 Metro Ground Works 21, stand 27 request proceed to work in progress taxiway Hotel	 Works 21, proceed to taxiway Hotel via Kilo and Alpha
 Metro Ground, Works 3, stand 27 request proceed to work in progress on taxiway Hotel, via runway 34	 Works 3, via Alpha 1 and Charlie 1 cross runway 34, proceed to taxiway Hotel
 Via Alpha 1 and Charlie 1 cross runway 34, proceed to taxiway Hotel, Works 3	

- 4.2.2 If the controller is too busy he will reply 'standby'. This means that the driver should wait until the controller calls back. The driver shall **not** proceed until permission is given.
- 4.2.3 When there is conflicting traffic the controller may reply 'hold position'. This means that the driver shall not proceed until the controller calls back with permission. All other replies should contain a clearly defined point to which the driver may proceed; this may or may not be the intended destination. If it is not the intended destination drivers must stop at this point and further permission shall be requested.







 Tels 5, by the control tower request proceed to hangar 3	 Tels 5, hold position
	 Holding, Tels 5
 Tels 5, at Charlie 8 request proceed to hangar 3	 Tels 5, proceed holding point Charlie 1 runway 14, via Alpha and Bravo
	 Proceed holding point Charlie 1 runway 14, Tels 5, via Alpha and Bravo

NOTE: The vehicle has only been cleared as far as the holding position to await runway crossing clearance and permission to proceed to hangar 3.

- 4.2.4 The controller/FISO may include the instruction 'hold short' to reinforce the point beyond which the vehicle may not proceed.









 Tels 5, by the control tower request proceed to hangar 3	 Tels 5, proceed holding point Charlie 1, hold short of runway 14
	 Proceed holding point Charlie 1, hold short of runway 14, Tels 5

- 4.2.5 Permission to proceed on the apron may include instructions to ensure safe operations.



 Tug 5, stand 21 request proceed to stand 26	 Tug 5, after the BIGJET BAe 146 on your right has passed, proceed to stand 26, caution jet blast
	 After the BAe 146 has passed proceed stand 26, Tug 5
 Checker 1, caution work in progress north side of taxiway Hotel	 Roger, Checker 1
 Fire 1, report your position	 Fire 1, taxiway Bravo by the maintenance hangar

4.3 To Cross a Runway

- 4.3.1 Drivers should note carefully the position to which they may proceed, particularly where the intended route involves crossing a runway. Some aerodromes may have procedures that will allow vehicles to proceed to a holding point on the movement area and then request runway crossing instructions. Under no circumstances shall a driver cross a runway unless **positive permission has been given and acknowledged**. A runway vacated report should not be made until the vehicle (and tow) is clear of the designated runway area.
- 4.3.2 In order to prevent unauthorised runway incursions, when an ATS Unit issues an instruction to cross a runway, the appropriate holding point designator shall be included in the instruction. A vehicle driver should query any instruction that identifies a holding point designator inconsistent with the vehicle location, or the driver's request, before proceeding onto the runway.

 Ops 1, on the Southern Apron request proceed to Northern Apron, via runway 27	 Ops 1, proceed holding point Alpha 2 via Alpha and Bravo hold short of runway 27
	 Proceed holding point Alpha 2 via Alpha and Bravo hold short of runway 27, Ops 1
 Ops 1, holding point Alpha 2 runway 27 request cross	 Ops 1, via Alpha 2 and Charlie 2 cross runway 27, report vacated
	 Via Alpha 2 and Charlie 2, cross runway 27, wilco, Ops 1
 Ops 1, runway 27 vacated	 Ops 1, proceed to Northern Apron
	 Proceed to Northern Apron, Ops 1

Where it is not possible for the controller to issue permission to cross the runway, alternative instructions may be given.

 Ops 1, on the Southern Apron request proceed to Northern Apron via runway 27	 Ops 1, negative, proceed to Northern Apron via Perimeter Road
	 Proceed to Northern Apron via Perimeter Road, Ops 1

Positive permission must be given and acknowledged before a vehicle driver enters a runway to carry out a specialised task.

 Checker 1, holding point Charlie 1 request enter runway 05 for surface inspection

 Checker 1, via holding point Charlie 1 enter runway 05, report vacated

 Via holding point Charlie 1 enter runway 05, wilco, Checker 1

- 4.3.3 If a vehicle is operating on the runway, it will be instructed to vacate the runway when it is expected that an aircraft will be landing or taking off.

 Works 21, vacate runway 27 at Alpha 1, report vacated

 Vacate at Alpha 1, wilco, Works 21

 Works 21, runway 27 vacated

 Works 21

- 4.3.4 When a vehicle is moving on the movement area it may be necessary to inform the vehicle of a potentially dangerous situation and to tell it to stop.

 Works 21, stop immediately aircraft crossing ahead

 Stopping, Works 21

4.4 Vehicles Towing Aircraft

Drivers of vehicles required to tow aircraft should not assume that the receiving station is aware that an aircraft is to be towed. The performance and manoeuvrability of ground vehicles is obviously considerably reduced when towing aircraft and this is taken into account when instructions to such vehicles are issued. Therefore, in order to avoid any confusion, and as an aid to identification, drivers should state the type, and where applicable the operator, of the aircraft to be towed in the first call.

 Ground Tug 9, request tow BIGJET BAe 146 from stand 25 to maintenance hangar 3

 Tug 9, tow approved from stand 25 to maintenance hangar 3 via taxiway Echo

 Tow approved from stand 25 to maintenance hangar 3 via taxiway Echo, Tug 9

Where it is necessary for the tug to push an aircraft back from a parking standing before towing, this should be included.

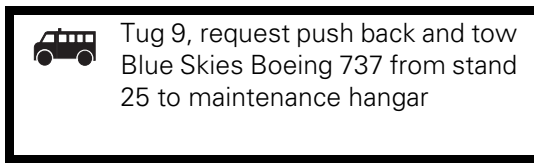

4.5 Low Visibility Procedures

Arrangements for notifying low visibility procedures vary between aerodromes and may include a broadcast by the controller.

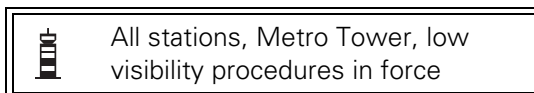

4.6 Messages regarding Safety of an Aircraft

Information regarding the safety of a specific aircraft should be transmitted to the controller/FISO.

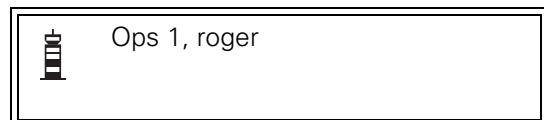

4.7 Messages regarding Wildlife

Drivers should follow the procedures for their particular aerodrome when reporting sightings of wildlife.

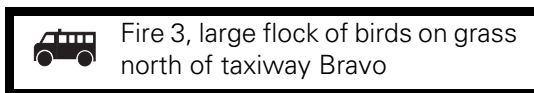

4.8 Driver unsure of Position

If a driver is lost or unsure of the vehicle's location he should inform the controller/FISO immediately and follow instructions.

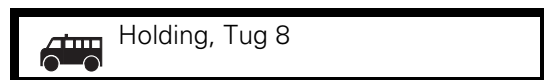
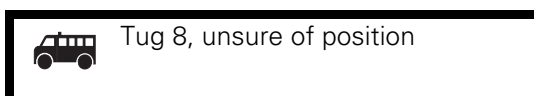

4.9 Broken-Down Vehicle

The driver of a broken-down vehicle should inform the controller/FISO immediately, including precise information regarding the vehicle's location and follow the aerodrome's procedures for broken-down vehicles.

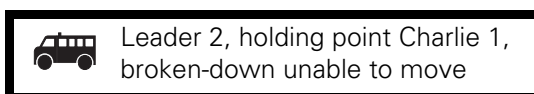

4.10 Radio Failure

In the event of a radio failure, drivers should follow the procedures for their aerodrome and comply with any light signals by the controller/FISO.

5 Aerodrome Air/Ground Communication Service Phraseology

5.1 Introduction

- 5.1.1 Concise and unambiguous phraseology used at the correct time is vital to the smooth, safe and expeditious running of an aerodrome and associated ATZ. It is not only the means by which information is passed but it also assists pilots in maintaining an awareness of other traffic in their vicinity, particularly in poor visibility conditions.
- 5.1.2 Messages will not be transmitted to an aircraft during take-off, the last part of final approach or the landing roll, unless it is necessary for safety reasons, because it will be distracting to the pilot at a time when the cockpit workload is often at its highest.
- 5.1.3 Local procedures vary from aerodrome to aerodrome and it is impossible to give examples to cover every situation which may arise at the multiplicity of different types of aerodrome. Information in addition to that shown in the examples, e.g. time checks, etc. may be provided as necessary.

5.2 Type of Service

- 5.2.1 As described in Chapter 2 the type of service provided at an aerodrome falls into one of three categories. In this section the examples are confined to those used by Air/Ground Communication Service operators.
- 5.2.2 Whilst the RTF procedures used by air traffic controllers and FISOs form the main content of this publication it should be noted that the phraseology used by Air/Ground Communication Service operators is different from that used by controllers and FISOs. This section describes only the phraseology provided by AGCS operators and details of the service itself may be found in CAP 452 Aeronautical Radio Station Operator's Guide on the CAA web site or from the CAA's printers (Details can be found on the inside cover of this publication). Phraseology for aerodrome air traffic controllers may be found in Chapter 4 paragraph 1 and that for FISOs in Chapter 4 paragraph 2.
- 5.2.3 An AGCS radio station operator is not necessarily able to view any part of the aerodrome or surrounding airspace. Traffic information provided by an AGCS radio station operator is therefore based primarily on reports made by other pilots. Information provided by an AGCS radio station operator may be used to assist a pilot in making decisions, however, the safe conduct of the flight remains the pilot's responsibility.

5.3 Air/Ground Station Identification

Radio operators must ensure that the full callsign, including the suffix 'RADIO', is used in response to the initial call from an aircraft and on any other occasion that there is doubt.

5.4 Phraseology and Examples

- 5.4.1 From time to time air traffic controllers and flight information service officers are invited by aerodrome authorities to provide an Air/Ground Communication Service. They are permitted to do so in certain circumstances provided they hold a valid Certificate of Competence (CA 1308). However, air traffic controllers, in particular, must appreciate that there is a considerable difference between the service they normally provide and the Air/Ground Communication Service. Therefore they must be careful not to lapse into providing an air traffic control service.

- 5.4.2 Personnel providing an Air/Ground Communication Service must ensure that they do not pass a message which could be construed to be either an air traffic control instruction or an instruction issued by FISOs for specific situations. Clearances initiated by an air traffic control unit may be relayed but the name of the authority must be included in the message, e.g:

'London control clears you to join controlled airspace . . . '





NOTE: Air Traffic Control clearances passed to radio operators to be issued on behalf of the ATC unit are to be read back in full to the issuing authority. The pilot is to readback, in full, the clearance relayed by the Air/Ground Communication Service operator.

















Table 3





















Event	Response
A/C requests taxi information	(Aircraft callsign) runway (designation) left/right hand circuit wind number (degrees) number (knots) QFE/QNH (pressure) millibars.
A/C reports wishing to cross a runway	(Aircraft callsign) (traffic information e.g. no reported traffic or, after the (aircraft type) has landed no reported traffic).
A/C reports ready to take off	(Aircraft callsign) no reported traffic (or traffic is...) surface wind (number) degrees (number) knots.
A/C reports airborne	(Aircraft callsign) roger
A/C overflying reports entering ATZ or asks for traffic information	(Aircraft callsign) (traffic information) (aerodrome information)
A/C requests joining information for a landing	(Aircraft callsign) runway (designation) left/right hand circuit surface wind (number) degrees (number) knots, QFE/QNH (pressure) millibars (traffic information).
A/C reports joining circuit	(Aircraft callsign) roger, (plus, when applicable, updated traffic information and any changes to aerodrome information).
A/C reports landed and/or runway vacated	(Aircraft callsign) (any appropriate aerodrome information).

NOTE: Air ground operators must not use the expression 'at your discretion' as this is associated with the service provided by FISOs and is likely to cause confusion to pilots.

- 5.4.3 An example of a typical RTF exchange is detailed below:

	Seaton Radio, G-ABCD, radio check 123.0 and request taxi information		G-ABCD, Seaton Radio, readability 5 runway 23 left hand circuit QNH 1022
			G-ABCD, readability 5 also, taxiing for runway 23 left hand QNH 1022
			G-CD, Roger

 G-CD, ready for departure	 G-CD, Roger. No reported traffic, surface wind 230 degrees 10 knots
	 Roger, taking off, G-CD
or,	
 G-CD, traffic is a Cherokee reported final, surface wind 230 degrees 10 knots	 Roger, taking off, G-CD
	or,
	 Roger, holding position, G-CD
once Cherokee has landed and vacated	
 G-CD, lining-up and taking off	 G-CD, Roger, surface wind 230 degrees 10 knots
	 G-CD, leaving the circuit to the west. Will report when re-joining
	 G-CD, Roger two other aircraft reported operating VFR to the west
	 Roger, G-CD
 Seaton Radio, G-BCDA, request traffic information	 G-BCDA, Seaton Radio, pass your message
	 G-BCDA, PA28 from Westbury to Millom position overhead Marlow, 1800 feet on QNH 1021, estimate Seaton at 15
	 G-DA, Roger. Runway 23 is active left hand with a Cessna 172 reported downwind QNH 1022
	 QNH 1022 will report overhead, G-DA

 G-DA, overhead at 15 will report leaving the frequency	 G-DA, Roger
	 G-DA, now leaving the ATZ changing to Wrayton information 124.75
	 G-DA, Roger
 Seaton Radio, G-ABCD, 6 miles west of Seaton request join	 G-CD, Seaton, runway 23 left hand, QFE 1021. Traffic is a Cessna 172 reported left base
	 Roger. Runway 23 left hand circuit, QFE 1021, G-CD
 G-CD, overhead joining for runway 23	 G-CD, Roger no reported traffic
or,	
 G-CD, downwind	 G-CD, Roger no reported traffic
 G-CD, final	 G-CD, Roger surface wind 220 15. Traffic is a Cessna 172 reported lining up to depart
	 Roger, G-CD.
 G-CD, vacated left and returning to the club	 G-CD, Roger
 G-CD, ready to cross runway 15	 G-CD, Roger no reported traffic
	 Roger, G-CD. Is there a convenient parking space
	 G-CD, parking available next to the blue Cessna 152

5.5 Offshore Communication Service

5.5.1 Introduction

Aeronautical radio stations located offshore on rigs, platforms and vessels provide an air-ground service to helicopters operating in the vicinity.

5.5.2 Offshore Station Identification

Offshore radio stations must identify themselves using the callsign specified by the CAA in the approval document.

5.5.3 Offshore Phraseology

Actual communications will follow a pattern dictated by the individual circumstances. However, in the interests of conformity and to avoid misunderstandings, a selection is given of the types of messages a helicopter pilot may pass, their meaning where necessary and the response which should be made.

Table 4

Helicopter	Response
(Offshore station callsign) (Aircraft callsign) Take the Flight Watch (You are requested to maintain radio watch until watch is taken by another station)	(Aircraft callsign) (Offshore station callsign) I have the Flight Watch
(Offshore station callsign) (Aircraft callsign) position ...	(Aircraft callsign) (Offshore station callsign) Roger
(Offshore station callsign) (Aircraft callsign) Report your weather	(Aircraft callsign) (Offshore station callsign) Weather <i>(State the following information as appropriate)</i> Surface Wind (number) degrees (number) knots, Visibility (distance) kilometres/metres, Weather (rain, snow, showers, etc.), Cloud few/scattered etc., (number) feet estimated, Ambient temperature (number), Helideck temperature (number), (Name of Area) QNH (pressure) (millibars), QFE (pressure) (millibars), Pitch (number) degrees: Roll (number) degrees: Heave (number) metres <i>(as appropriate)</i>
(Offshore station callsign) (Aircraft callsign) Switch on the NDB	(Aircraft callsign) (Offshore station callsign) Wilco NDB frequency (number) kHz ident (letters) <i>(if requested)</i>
(Offshore station callsign) (Aircraft callsign) ETA is (time)	(Aircraft callsign) (Offshore station callsign) Roger
(Offshore station callsign) (Aircraft callsign) Landing in (number) minutes	(Aircraft callsign) (Offshore station callsign) Roger
(Offshore station callsign) (Aircraft callsign) overhead	(Aircraft callsign) (Offshore station callsign) Roger

Table 4 (Continued)

Helicopter	Response
(Offshore station callsign) (Aircraft callsign) Beacon outbound (<i>this indicates the pilot is using the NDB as a navigational aid to take him from overhead to a point where he can safely descend below cloud and return under visual conditions to the helideck</i>)	(Aircraft callsign) (Offshore station callsign) Roger
(Offshore station callsign) (Aircraft callsign) Is the deck available for landing?	(Aircraft callsign) (Offshore station callsign) Affirm Deck available (for landing) <i>or</i> Deck obstructed, expect (number) minutes delay, <i>or</i> Deck closed due to (reason), expect (number) minutes delay <i>Note: Transmission of 'for landing' is optional</i>
(Offshore station callsign) (Aircraft callsign) Ready for departure	(Aircraft callsign) (Offshore station callsign) Roger (<i>or pass relevant information</i>)
(Offshore station callsign) (Aircraft callsign) Departing	(Aircraft callsign) (Offshore station callsign) Roger
(Offshore station callsign) (Aircraft callsign) Switch off the NDB	(Aircraft callsign) (Offshore station callsign) Wilco
(Offshore station callsign) (Aircraft callsign) Radio contact with (ATS Unit), close down the Flight Watch	(Aircraft callsign) (Offshore station callsign) Closing down Flight Watch
Additionally the following are applicable to vessels:	
(Vessel callsign) (Aircraft callsign) Report position	(Aircraft callsign) (Vessel callsign) Position (lat/long)
(Vessel callsign) (Aircraft callsign) Report course and speed	(Aircraft callsign) (Vessel callsign) Course and speed (number) degrees (number) knots
(Vessel callsign) (Aircraft callsign) Report relative wind (Relative to the ship's heading)	(Aircraft callsign) (Vessel callsign) Relative wind Port/Starboard (number) degrees (number) knots
(Vessel callsign) (Aircraft callsign) Maintain course and speed	(Aircraft callsign) (Vessel callsign) Roger
(Vessel callsign) (Aircraft callsign) Alter course Port/Starboard (number) degrees	(Aircraft callsign) (Vessel callsign) Standby. Course now (number) degrees
(Vessel callsign) (Aircraft callsign) Change speed to (number) knots	(Aircraft callsign) (Vessel callsign) Standby. Speed now (number) knots

NOTE 1: The phrase 'Deck available (for landing)' replaces the previously used phrase, 'Deck is clear for landing', in order to avoid any possible confusion with a landing clearance that may be issued by an Air Traffic Control unit. For operational purposes, the two terms should be considered to have the same meaning.

NOTE 2: Procedures for certain messages (e.g. when following the requirements for notification of the flight when there is no ATSU at the destination – see AIP ENR 1.10), including the phraseology to be used, should be contained in the aircraft operator's standard operating procedures and local operating procedures. These messages are not air traffic service messages and are not reproduced in this document.

5.5.4 Helideck Movement

- 5.5.4.1 Helicopter crews must be provided with accurate information regarding the pitch, roll and heave of the helideck. Reports on pitch and roll should include values, in degrees, about both axes of the true vertical datum (i.e. relative to the true horizon) and be expressed in relation to the vessel's heading.
- 5.5.4.2 Pitch should be expressed in terms of 'up' and 'down' and roll should be expressed in terms of 'left' and 'right'. Heave should be reported in a single figure, being the total heave motion of the helideck rounded up to the nearest metre. Heave is taken to be the vertical difference between the highest and lowest points of the helideck movement.
- 5.5.4.3 A standard radio message should be passed to the pilot containing the information on the helideck movement in an unambiguous format. Should the crew require other motion information or amplification of the standard message, they will request it.
- 5.5.4.4 An example of the 'standard message' would be: '(Pitch, roll and heave). Roll one degree left and three degrees right; pitch two degrees up and two degrees down; heave two metres'.

6 Radiotelephony Reports at Unattended Aerodromes

6.1 Introduction

- 6.1.1 Where an aeronautical communications frequency is allocated for use at a United Kingdom aerodrome, all RTF communications are to be conducted on the allocated frequency. For licensed aerodromes, allocated frequencies are promulgated in the UK AIP. A common frequency (135.475 MHz) known as 'SAFETYCOM' is made available for use at aerodromes where no other frequency is allocated (UK AIP GEN 3.4 refers) to enable pilots to broadcast their intentions to other aircraft that may be operating on, or in the vicinity of, the aerodrome.
- 6.1.2 At some UK aerodromes, air traffic movements may occur outside the promulgated hours of watch of Air Traffic Services (ATS). In order to improve the safety of these aerodrome operations, pilots should broadcast information on their intentions to other aircraft that may be operating on, or in the vicinity, of the aerodrome.
- 6.1.3 The phraseology to be used at an unattended aerodrome, as described in this section, is not to be used at aerodromes with ATS in attendance. Where ATS is provided, the relevant ATS unit will issue appropriate instructions.
- 6.1.4 All transmissions at unattended aerodromes shall be addressed to '(Aerodrome name) Traffic'. No reply to an unattended aerodrome report shall be transmitted.
- 6.1.5 Pilot reports are described for a Standard Overhead Join. This procedure will allow pilots to determine the runway in use and to orientate themselves with the circuit direction and other traffic. As specific joining and circuit procedures exist for some aerodromes, pilots should refer to the UK AIP to establish the procedure to be followed.
- 6.1.6 Unattended aerodrome reports are made at the discretion of the pilot. However, to ensure the traffic awareness of other pilots is correctly maintained, if a pilot elects to make reports, all those reports not listed as 'optional' should be included. Optional calls (illustrated in paragraph 6.3) may be included if additional traffic information is likely to assist traffic organisation or to enhance safety.
- 6.1.7 Monitoring of unattended aerodrome reports is not a substitute for visual observation and pilots must maintain traffic awareness and lookout even when making such calls, as not all aircraft may be monitoring radio broadcasts.
- 6.1.8 Transmission of unattended aerodrome reports does not confer any right-of-way. Pilots shall comply at all times with the Rules of the Air Regulations, in particular the rules for avoiding aerial collisions.

6.2 Additional Procedures for the Use of SAFETYCOM

- 6.2.1 SAFETYCOM is not an Air Traffic Service and no aeronautical ground station is associated with SAFETYCOM.
- 6.2.2 SAFETYCOM is a single common frequency and pilots should be aware of the possibility of congestion and breakthrough. It is particularly important when using SAFETYCOM that RTF transmissions identify the aerodrome name (suffixed 'traffic') in order to indicate the relevance of the report to other aircraft. Transmissions must be correct and concise.
- 6.2.3 SAFETYCOM transmissions shall only be made when aircraft are not more than 2000 ft above aerodrome level, or not more than 1000 ft above promulgated circuit height (if applicable) and within 10 NM of the aerodrome of intended landing.

6.2.4 Where an aerodrome lies within controlled airspace, pilots are to call the appropriate ATSU and ensure that they obtain clearance to enter the airspace.

6.3 Unattended Aerodrome Phraseology Examples

6.3.1 Taxiing Phraseology Example

 Borton Traffic, G-ABCD, TAXIING for Runway 09

This transmission is optional and may be advisable at airfields where the view from an aircraft either in the air or on the ground may be restricted.

6.3.2 Departure Phraseology Example

 Borton Traffic, G-ABCD, LINING UP for departure Runway 09

6.3.3 Joining the Circuit Phraseology Examples

 Borton Traffic, G-ABCD, 10 miles southwest JOINING OVERHEAD

 Borton Traffic, G-ABCD, Overhead joining for Runway 09 (*if determined*)

This transmission is optional and may be advisable depending on other traffic in the vicinity

 Borton Traffic, G-ABCD, Dead side descending Runway 09

This transmission is optional and may be advisable depending on other traffic in the vicinity

6.3.4 Reporting in the Circuit Phraseology Examples

 Borton Traffic, G-ABCD, DOWNWIND (*Right-hand if applicable*) Runway 09 (*Intentions if applicable*)

 Borton Traffic, G-ABCD, BASE LEG Runway 09

This transmission is optional and may be advisable depending on other traffic in the vicinity

 Borton Traffic, G-ABCD, FINAL Runway 09

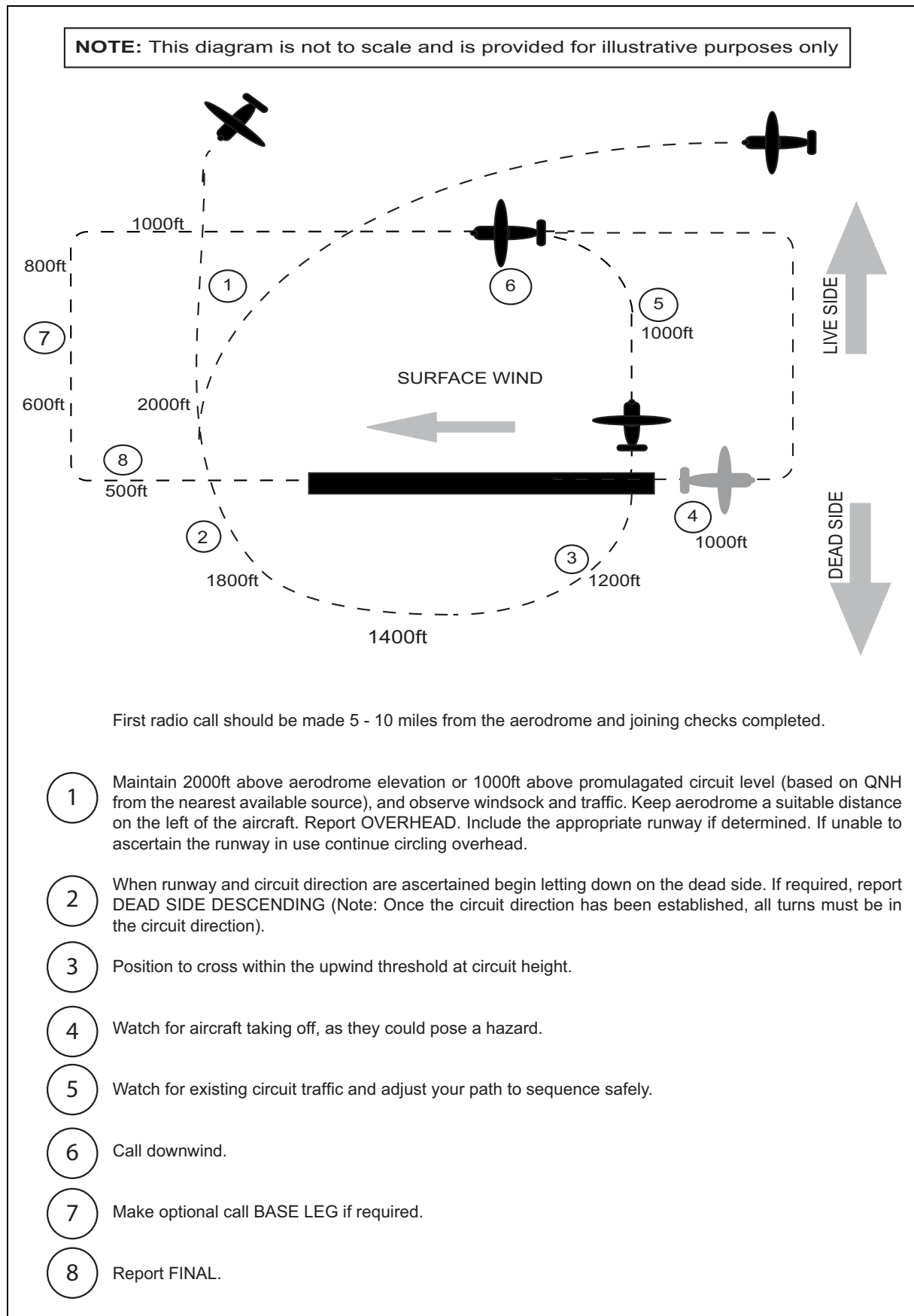

Figure 2 Standard Overhead Join Procedure
See paragraph 1.8.3 for additional information regarding overhead join procedures

7 Aerodrome Information

7.1 Meteorological Conditions

Meteorological information in the form of reports, forecasts or warnings is made available to pilots using the aeronautical mobile service either by broadcast (e.g. VOLMET) or by means of specific transmissions from ground personnel to pilots. Standard meteorological abbreviations and terms should be used and the information should be transmitted slowly and enunciated clearly in order that the recipient may record such data as is necessary.

 <p>G-CD, Borton Tower, 0950 weather surface wind 360 degrees 5 knots visibility 30 km. Nil weather, 2 oktas 2500 feet temperature plus 10, dew point plus 3, QNH 1010</p>	 <p>QNH 1010, G-CD</p>
---	---

NOTE: Cloud may also be reported as follows:

'Scattered at five hundred feet, scattered cumulonimbus at one thousand feet, broken at two thousand five hundred feet.'

In the above example 'scattered' equates to 3 or 4 Octas and 'broken' equates to 5–7 Octas.

Full details of meteorological information are contained in UK AIP GEN section. Information on military aerodromes and weather information is in Chapter 10 paragraph 3.3.

7.2 Voice Weather Broadcast (VOLMET) UK

7.2.1 Meteorological aerodrome reports for certain aerodromes are broadcast on specified frequencies. The callsign of the VOLMET, frequency, operating hours, aerodromes contained within the group, and contents are published in the UK AIP.

7.2.2 The content of a VOLMET broadcast is as follows:

- a) Aerodrome identification (e.g. Stourton)
- b) Surface wind
- c) Visibility (Note 1)
- d) RVR (if applicable) (Note 1)
- e) Weather
- f) Cloud (Note 1)
- g) Temperature
- h) Dewpoint
- i) QNH
- j) Trend (if applicable)

NOTES:

- 1 Non essential words such as 'surface wind', 'visibility' etc. are not spoken.
- 2 'SNOCLO' is used to indicate that aerodrome is unusable for take-off/landings due to heavy snow on runways or snow clearance.
- 3 All broadcasts are in English.

7.3 Runway Visual Range (RVR)/Visibility/Absolute Minimum

7.3.1 When transmitting the runway visual range the abbreviation RVR will be used without using the phonetic word for each letter, e.g. RVR runway 27, 800 metres. The runway designator may be omitted if there is no possibility of confusion.

7.3.2 Where instrumented RVR (IRVR) is not available, RVR for the purposes of Category 1 and non-precision instrument approach operations may be assessed by human observer and transmitted by the controller to the pilot.

 BIGJET 347, RVR 400 metres
--

7.3.3 If the assessed value is more than the maximum reportable value, controllers are to advise the pilot.

 BIGJET 347, RVR is greater than 1200 metres

7.3.4 If no lights are visible controllers are to state "RVR less than (number) metres, inserting the value corresponding to one light.

 BIGJET 347, RVR less than 60 metres
--

7.3.5 Occasionally pilots of aircraft may report, or observations from the control tower may indicate that the visibility conditions on the runway are significantly different to those being reported. Under no circumstances is a controller to pass a pilot information which suggests that the visibility is better than the RVR reported. However, when a pilot's report or an observation from the tower indicates a worse condition on the runway this information is to be passed to the pilot with subsequent RVR reports for as long as the condition is considered to exist.

 BIGJET 347, RVR 400 metres. Thicker patches reported further along the runway by the pilot of a landing aircraft

 BIGJET 347, RVR 400 metres. Thicker patches observed further along the runway from the control tower

7.3.6 Where RVR is not available the pilot is to be advised..

 BIGJET 347, RVR runway 27 not available

 BIGJET 347, RVR runway 27 not reported
--

- 7.3.7 Where instrumented runway visual range (IRVR) observations are available, more than one reading may be transmitted.

 BIGJET 347, RVR runway 27, 650
600 600 metres

 BIGJET 347

 BIGJET 347, RVR runway 27,
touchdown not available, mid point
650, stop end 550 metres

 BIGJET 347

- 7.3.8 In the UK, there is an approach ban which states that a pilot may not continue an instrument approach beyond the outer marker or equivalent position, if the reported RVR, or at aerodromes where RVR measurements are not taken or available, the visibility, is below the minimum specified for that approach. Essentially, this means that a pilot may not descend below 1,000 feet above the aerodrome when these conditions exist. This RVR/visibility is known as an 'absolute minimum'.

- 7.3.9 Should a pilot indicate that he or she intends to commence an instrument approach when the reported RVR/visibility is less than the notified 'absolute minimum' value, the controller should inform the pilot using the following RTF phraseology:

 BIGJET 347, you are advised that the
current RVR/visibility is (number)
metres which is below the absolute
minimum for a (name) approach to
runway (number). What are your
intentions?

- 7.3.10 If the pilot states that he still intends to continue the approach below 1000 ft above aerodrome level, the controller shall inform the pilot.

 BIGJET 347, if you continue the
approach and descend below 1000
feet above aerodrome level, it is
believed that you will be
contravening UK legislation and I
shall be required to report the facts.
Acknowledge

- 7.3.11 This shall be followed at the appropriate times by the following transmissions.

 BIGJET 347, there is no known
traffic to affect you making a (name)
approach to runway 30

 BIGJET 347, there is no known
traffic to affect you landing, surface
wind 280 degrees 16 knots

7.4 Runway Surface Conditions

7.4.1 When conditions of standing water, with or without reports of braking action, are brought to the attention of ATS, the available information will be passed to aircraft likely to be affected.

7.4.2 When reports are based on inspections of the runway surface made by the aerodrome authority, the presence or otherwise of surface water on a runway will be assessed over the most significant portion of the runway (i.e., the area most likely to be used by aircraft taking off and landing).

NOTE: This area may differ slightly from one runway to another but will approximate to the central two-thirds of the width of the runway extending longitudinally from a point 100 m before the aiming point to 100 m beyond the aiming point for the reciprocal runway.

7.4.3 The presence or otherwise of surface water on a runway is reported in RTF and ATIS broadcasts using the following descriptions:

Table 5

Reporting Term	Surface conditions
DRY	The surface is not affected by water, slush, snow, or ice. NOTE: Reports that the runway is dry are not normally to be passed to pilots. If no runway surface report is passed, pilots should assume the surface to be dry.
DAMP	The surface shows a change of colour due to moisture. NOTE: If there is sufficient moisture to produce a surface film or the surface appears reflective, the runway will be reported as WET.
WET	The surface is soaked but no significant patches of standing water are visible. NOTE: Standing water is considered to exist when water on the runway surface is deeper than 3mm. Patches of standing water covering more than 25% of the assessed area will be reported as WATER PATCHES.
WATER PATCHES	Significant patches of standing water are visible. NOTE: Water patches will be reported when more than 25% of the assessed area is covered by water more than 3mm deep.
FLOODED	Extensive patches of standing water are visible. NOTE: Flooded will be reported when more than 50% of the assessed area is covered by water more than 3mm deep.

7.4.4 Reports originated by the Aerodrome Authority are based on runway inspections and include the conditions in each third of the assessed area, sequentially, for the runway to be used.

	BIGJET 347, Runway 26 surface is DAMP, WATER PATCHES, WET
--	--

	BIGJET 347, Runway 34 surface is WET, WET, WET
--	---

- 7.4.5 Additional information, based on observations from the control tower or from pilot reports that indicate that the amount of water present on the runway surface is greater than that assessed, may be passed to pilots. Such additional information will be prefixed by the words "Unofficial observation". In this case, the runway surface conditions will be advised using a single term for the entire runway.

	<p>BIGJET 347, Unofficial observation based on pilot report. The runway 34 surface condition appears to be WET</p>
---	--

- 7.4.6 When suitable equipment is available reports of braking action on wet runways will be passed to pilots.

- 7.4.7 Other runway surface conditions, which may be of concern to a pilot, will be passed by ATS.

	<p>BIGJET 347, displaced threshold runway 27, 100 metres due broken surface</p>
---	---

	<p>BIGJET 347, braking action reported by B737 at 1456 poor</p>
---	---

7.5 Automatic Terminal Information Service (ATIS) UK

- 7.5.1 To alleviate RTF loading at some busy airports, Automatic Terminal Information Service (ATIS) messages are broadcast to pass routine arrival/departure information on a discrete RTF frequency or on an appropriate VOR. Pilots inbound to these airports are normally required, on first contact with the aerodrome ATISU, to acknowledge receipt of current information by quoting the code letter of the broadcast. Pilots of outbound aircraft are not normally required to acknowledge receipt of departure ATIS except when requested on the actual ATIS broadcast. If, however, pilots report receipt of a departure ATIS broadcast the QNH should be included, thereby allowing ATC to check that the quoted QNH is up-to-the-minute.

- 7.5.2 Aerodromes possessing ATIS, the hours of ATIS operation and the frequency employed are published in the UK AIP.

- 7.5.3 ATIS broadcasts (which should be no more than thirty seconds duration) will include all or part of the elements of the information shown in the Manual of Air Traffic Services Part 1, Section 3, Paragraph 11.7 in the order listed.

- 7.5.4 Example of ATIS broadcast:

'This is Stourton Approach Information Alpha. 0850 hours weather. Runway 28. 240 degrees 12 kt. 10 km. Intermittent slight rain. Scattered at 1000 ft, overcast at 1800 ft. Temperature +12. Dew point +7. QNH 1011. Report information Alpha received on first contact with Stourton.'

NOTES:

- 1) A Trend may be included in an ATIS broadcast.
- 2) Rapidly changing meteorological situations sometimes make it impractical to include weather reports in the broadcast. In these circumstances, ATIS messages will indicate that weather information will be passed on RTF.
- 3) Any significant change to the content of a current ATIS message will be passed to pilots by RTF until such time as a new message is broadcast.

- 7.5.5 Military Weather and Aerodrome Information appear in Chapter 10 paragraph 3.3.

Chapter 5 Radar Phraseology

1 General

1.1 Introduction









1.1.1 This Chapter contains general radar phraseology which is commonly used in communications between aircraft and all types of radar unit. Phraseology which is more applicable to approach radar control or area control is to be found in Chapters 6 and 7 as appropriate.

1.1.2 The phrase 'radar control' shall only be used when a radar control service is being provided. Normally however, the callsign suffix used by the radar unit is sufficient to indicate its function.

1.1.3 In a radar environment heading information given by the pilot and heading instructions given by controllers are normally in degrees magnetic.

1.2 Radar Identification of Aircraft

1.2.1 An aircraft must be identified before it can be provided with an ATS surveillance service. However, the act of identifying aircraft is not a service in itself and pilots should **not** assume that they are receiving an ATS surveillance service, particularly when they are flying outside controlled airspace.

 G-CD, report heading	 G-CD, heading 350
 G-CD, for identification turn left heading 320 degrees	 Left heading 320 degrees, G-CD
 G-CD, identified 18 miles north-west of Borton, Deconfliction Service	 Deconfliction Service, G-CD
or,	
 G-CD, not identified. Resume own navigation	 Wilco, G-CD

1.2.2 The instruction to report heading may be expanded to “report heading and level”.

 G-CD, report heading and level

 G-CD, heading 350 altitude 2400 feet

1.2.3 When a controller has identified an aircraft he will inform the pilot, according to the circumstances, of the following:

- a) that the aircraft is identified, and
- b) of the position of the aircraft.

The occasions when the above information will be passed are summarised in Table 1 below. Additionally, controllers may pass position information to aircraft whenever they consider it necessary.

Table 1

Method of Identification	Aircraft flying inside controlled airspace		Aircraft flying outside controlled airspace*	
	Inform Identified	Pass Position	Inform Identified	Pass Position
SSR	No	No	Yes	No
Turn	Yes	Yes	Yes	Yes
Departing aircraft	No	No	Yes	No
Position Report	No	No	Yes	No

*When providing a Basic Service, a controller may identify an aircraft to facilitate co-ordination or to assist in the provision of generic navigational assistance, but is not required to inform the pilot that identification has taken place or to pass a position report.

1.2.4 The pilot will be warned if identification is lost, or about to be lost, and appropriate instructions given.

 G-CD, radar service terminated due radar failure. Resume own navigation. Basic service available from Wrayton on 125.750

 Changing to Wrayton 125.750, G-CD

 G-CD, will shortly be leaving radar cover, radar service terminated. Basic service available from Wrayton on 125.750

 G-CD, changing to Wrayton 125.750

 G-CD, Roger

1.3 Secondary Surveillance Radar Phraseology

1.3.1 The following phrases are instructions which may be given by controllers to pilots regarding the operation of SSR transponders. The phrases used by controllers are given together with their meanings; assignment of a code **does not** constitute the provision of ATS surveillance service.

Table 2











Phrase	Meaning
Squawk (code)	Set the code as instructed
Confirm squawk	Confirm the code set on the transponder
Reset squawk (code)	Reselect assigned code
Squawk Ident	Operate the special position identification feature
Squawk Mayday	Select Emergency
Squawk Standby	Select the standby feature
Squawk Charlie	Select altitude reporting feature
Check altimeter setting and confirm (level)	Check pressure setting and confirm your level
Stop squawk Charlie	Deselect altitude reporting
Stop squawk Charlie, wrong indication	Stop altitude report, incorrect level readout
* Confirm (level)	Check and confirm your level
** Check selected level. Cleared level is (correct cleared level)	Check and confirm your cleared level
Confirm you are squawking assigned code (code assigned to the aircraft by ATC)	To verify that 7500 has been set intentionally
*** Check altimeter setting (correct altimeter setting)	Check and confirm your altimeter setting

*Used to verify the accuracy of the Mode C derived level information displayed to the controller.

**Where selected flight level is seen to be at variance with an ATC clearance, controllers shall not state on the frequency the incorrect SFL as observed on the situation display. However, controllers may query the discrepancy using this phraseology. For ATC purposes, the generic phrase 'selected level' is used to encompass both altitude and flight level.

***Downlinked Mode S Barometric Pressure Setting data has the potential to assist in the prevention of level busts. Where such information is available to a controller and a discrepancy is observed between the QNH passed and that selected, a controller should query the discrepancy.



1.3.2 The pilot must respond to SSR instructions, reading back specific settings.

 BIGJET 347, squawk 6411	 6411, BIGJET 347
 BIGJET 347, squawk ident	 Squawk ident, BIGJET 347
 BIGJET 347, squawk 6411 and ident	 6411 and ident, BIGJET 347
 BIGJET 347, confirm squawk	 6411, BIGJET 347
 BIGJET 347, reset squawk 6411	 Resetting 6411, BIGJET 347

 BIGJET 347, check altimeter setting	 1013 set, BIGJET 347
 BIGJET 347, confirm transponder operating	 BIGJET 347, negative, transponder unserviceable

1.4 **ATS Surveillance Service**

Where it is not self-evident the controller will normally advise the pilot of the service being provided.









 BIGJET 347, Radar Control	 Radar Control, BIGJET 347
 G-CD, Deconfliction Service	 Deconfliction Service, G-CD
 G-CD, Traffic Service	 Traffic Service, G-CD
 BIGJET 347, radar service terminated	 BIGJET 347, Roger

1.5 **Radar Vectoring**







1.5.1 Aircraft may be given specific vectors to fly in order to establish separation. Pilots may be informed of the reasons for radar vectoring.

 BIGJET 347, for spacing turn left heading 050 degrees	 Left heading 050 degrees, BIGJET 347
---	--

1.5.2 It may be necessary for a controller to know the heading of an aircraft as separation can often be established by instructing an aircraft to continue on its existing heading.

 BIGJET 347, continue present heading	 Continue heading, BIGJET 347
 BIGJET 347, report heading	 BIGJET 347, heading 050 degrees
 BIGJET 347, continue present heading and report that heading	 Continue heading 050 degrees, BIGJET 347
 BIGJET 347, continue heading 050 degrees	 Continue heading 050 degrees, BIGJET 347

1.5.3 Heading instructions may also be combined with a turn instruction.

 BIGJET 347, turn left 30 degrees and report heading	 Turning left 30 degrees, wilco, BIGJET 347
 BIGJET 347, stop turn heading 240 degrees	 Stop turn heading 240 degrees, BIGJET 347
 BIGJET 347, continue turn heading 240 degrees	 Continue turn heading 240 degrees, BIGJET 347





1.5.4 A controller may not know the aircraft's heading but does require the aircraft to fly a particular heading.

 G-CD, fly heading 275	 Roger, turning left heading 275, G-CD
or,	
	 Roger, turning right 20 degrees heading 275, G-CD

1.5.5 The controller may instruct the aircraft to fly a particular heading after passing a specific point.

 BIGJET 347, leave Wicken heading 245	 Leave Wicken heading 245, BIGJET 347
--	--

1.5.6 When vectoring is complete, pilots will be instructed to resume their own navigation, given position information if considered necessary by the controller and appropriate instructions as necessary. Where a direct route is required, the controller shall include this in the instructions.

 BIGJET 347, resume own navigation direct Wicken, magnetic track 075 distance 27 miles	 Wilco, BIGJET 347
 G-CD, resume own navigation Walden position is 15 miles southeast of Westbury	 Wilco, G-CD

1.5.7 Occasionally an aircraft may be instructed to make a complete turn (known as an orbit or a 360 degree turn), for delaying purposes or to achieve a required spacing behind preceding traffic.

 G-CD, for spacing orbit left	 Orbit left, G-CD
--	--

 BIGJET 347, for spacing make a 360 turn left

 360 turn left, BIGJET 347

NOTE: 360 turn spoken as "TREE SIXTY TURN"

1.6 Traffic Information and Avoiding Action Phraseology

1.6.1 Whenever practicable, information regarding traffic on a possible conflicting path should be given in the following form:

- a) relative bearing of the conflicting traffic in terms of the 12 hour clock with the optional prefix 'left or right' as appropriate; or, if the aircraft under service is established in a turn, the relative position of the conflicting traffic in relation to cardinal points i.e. northwest, south etc.;
- b) distance from the conflicting traffic;
- c) direction of flight of the conflicting traffic; and
- d) relative speed of the conflicting traffic or the type of aircraft and level if this is known.

1.6.2 Relative movement and level should be described by using one of the following terms as applicable:

- a) 'closing, converging, parallel, same direction, opposite direction diverging, overtaking, crossing left to right, crossing right to left';
- b) 'indicating level (if known), unverified or 1000 feet above/below'; or,
- c) (when giving traffic information to an aircraft which is climbing or descending) '... 1000 feet above/below cleared level.'

 G-CD, traffic west, 5 miles, tracking east, indicating 1000 feet below cleared level

 G-CD, traffic south, 5 miles, tracking east, indicating similar height

1.6.3 The controller will inform the pilot when the conflict no longer exists.

 G-CD, traffic 10 o'clock 6 miles crossing left to right height unknown fast moving. If not sighted turn left heading 270 degrees

 Left heading 270 degrees, G-CD

 G-CD, clear of traffic resume own navigation direct Walden magnetic track 350 distance 13 miles

 Wilco, G-CD

- 1.6.4 Avoiding action to be taken by the pilot is given when the controller considers that an imminent risk of collision will exist if action is not taken immediately

 G-CD, avoiding action, turn left immediately heading 270 degrees traffic left 10 o'clock 5 miles crossing left to right indicating 3000 feet unverified

 Left heading 270 degrees, G-CD

or,

 G-CD, avoiding action descend immediately FL280. Traffic 12 o'clock, 10 miles opposite direction, same level

 Descend immediately FL280, G-CD

1.7 ACAS/TCAS Phraseology

- 1.7.1 ACAS/TCAS equipment reacts to transponders of other aircraft in the vicinity to determine whether or not there is a potential conflict. The warning (Traffic Advisory), based on the time to an assumed collision enables the pilot to identify the conflicting traffic, and if necessary, take avoiding action (Resolution Advisory). In the UK, this equipment is mainly referred to as 'TCAS', however, the use of 'ACAS' is an acceptable alternative in phraseology terms.

- 1.7.2 Pilots should report TCAS manoeuvres.

 BIGJET 347, TCAS RA

 BIGJET 347, Roger

- 1.7.3 The pilot should report when returning to the assigned clearance or when the assigned clearance has been resumed.

 BIGJET 347, clear of conflict, returning to (assigned clearance)

 BIGJET 347, Roger

 BIGJET 347, clear of conflict, (assigned clearance) resumed

 BIGJET 347, Roger

(Controllers may issue a revised clearance at this point.)

- 1.7.4 Pilots should report that they are unable to comply with a clearance as a result of a TCAS alert.

 BIGJET 347, unable TCAS RA

 BIGJET 347, Roger

In these circumstances the pilot should report when clear of the TCAS conflict.

- 1.7.5 The pilot should report a TCAS manoeuvre even if it was not possible to notify the controller that a resolution advisory had occurred.

1.8 Communications and Loss of Communications

When a controller suspects that an aircraft is able to receive but not transmit messages, the radar may be used to confirm that the pilot has received instructions. When further instructions are given they should be passed slowly, clearly and be repeated.

 G-CD, reply not received, if you read Wrayton turn left heading 040 degrees I say again turn left heading 040 degrees

 G-CD, turn observed 10 miles north of Wrayton I will continue to pass instructions

or,

 BIGJET 347, reply not received, if you read Wrayton squawk ident I say again squawk ident

 BIGJET 347, squawk observed 3 miles east of BTN I will continue to pass instructions

NOTES:

- 1 An aircraft experiencing a radio communications failure is expected to select the appropriate SSR code.
- 2 See also Chapter 8.

1.9 Essential Traffic Information

1.9.1 Essential traffic is traffic which is separated for any period by less than the specified standard separation. It is normally passed in situations when ATS surveillance systems are not available. Essential traffic information passed to an aircraft shall include:

- a) Direction of flight of conflicting aircraft;
- b) Type of conflicting aircraft;
- c) Cruising level of conflicting aircraft and ETA for the named reporting point, or for aircraft passing through the level of another with less than the normal separation; the ETA for the reporting point nearest to where the aircraft will cross levels and;
- d) Any alternative clearance

 BIGJET 347, essential traffic information, a westbound B737 maintaining FL80 estimating KTN at 50, descend FL90

- 1.9.2 The controller will also advise the pilot when there is no reported traffic and may provide a time check as required.

 BIGJET 347, no reported traffic

 BIGJET 347, time check 45

1.10 **Danger Area Crossing Service/Danger Area Activity Information Service**

- 1.10.1 In-flight information on the status of Danger Areas (DAs) is available from the nominated service units:

- a) listed in the UK AIP;
- b) detailed on the legend of the appropriate UK 1:500 000 Aeronautical Chart.

- 1.10.2 When available the DA service will either be a Danger Area Crossing Service (DACs) or a Danger Area Activity Information Service (DAAIS). If there is no reply from the appropriate nominated service unit that is to be called for these services, pilots are advised to assume that the relevant DA is active and remain outside.

1.10.3 **Danger Area Crossing Service**

- 1.10.3.1 The appropriate nominated service unit will, when the DA activity permits, provide a clearance for an aircraft to cross the danger area under a suitable type of service. The crossing clearance is only in relation to DA activity. The provision of deconfliction advice and/or traffic information in relation to other traffic, either inside or operating close to the DA, will be in accordance with the scope of the specific ATS provided, i.e. Deconfliction Service, Traffic Service or Basic Service.
- 1.10.3.2 When used by a DACs unit, the term 'active' means that the DA is published as active and that there is activity taking place. Where there is no possibility of confusion, the number of the DA may be replaced by the name, e.g. 'Danger Area Loudwater'.

 Westbury Approach, G-ABCD, request Crossing Service for Danger Area 113

 G-ABCD, Westbury Approach, Danger Area 113 active remain outside

 Danger Area 113 active remaining outside, changing to Wrayton Information 125.750, G-ABCD

 G-ABCD

1.10.3.3 When a DA is notified as not active, or is notified as active and it has been confirmed that there is no DA activity taking place, the DACS unit may provide a clearance for the aircraft to cross the DA. Where possible, the pilot should provide the nominated unit with an estimated crossing time as shown in the following example.

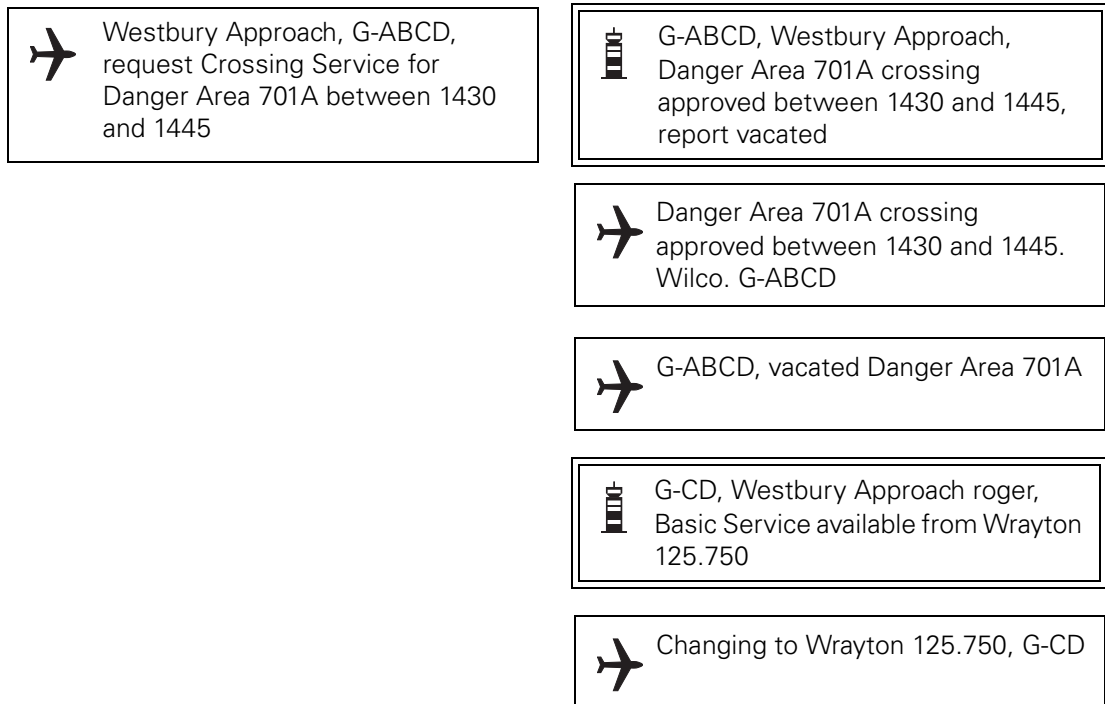

1.10.4 Danger Area Activity Information Service

1.10.4.1 The nominated service unit will pass to the pilot, on request, an update on the known activity status of the DA. Such an update will assist the pilot to decide whether it would be prudent, on flight safety grounds, to penetrate the DA. A DAAIS does NOT constitute a clearance to cross a DA.

1.10.4.2 When used by a DAAIS unit, the term 'active' means that, from the latest information available to the unit, including activity times where known, the DA is notified as active and it is not known whether there is activity taking place. Where a DACS is also available for the DA, the pilot may be provided with the appropriate frequency. In RTF transmissions DAAIS is pronounced "DAY-ES".

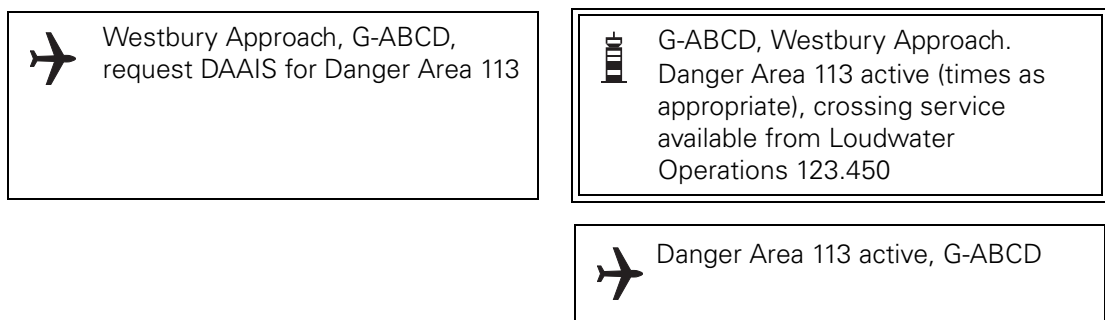

1.10.4.3 Alternatively the service unit will advise the pilot that the DA is 'not active'. When used by a DAAIS unit, 'not active' means that, from the latest information available to the unit, the DA is not notified as active.

 Westbury Approach, G-ABCD,
request DAAIS for Danger Area 113

 G-ABCD, Westbury Approach.
Danger Area 113 not active

 Danger Area 113 not active, G-ABCD

1.10.5 Full details of DACS/DAAIS can be found in the UK AIP and AICs.

INTENTIONALLY LEFT BLANK

Chapter 6 Approach Phraseology

1 Approach Control Service Phraseology

1.1 IFR Departures

1.1.1 At many airports both arrivals and departures are handled by a single approach control unit. At busier airports departures and arrivals may be handled separately.

1.1.2 Pilots of all aircraft flying Instrument Departures (including those outside controlled airspace) shall include the following information on initial with the first en-route ATS unit (see also Chapter 3, General Phraseology, paragraph 1.4.1):

- a) Call sign;
- b) SID or Standard Departure Route Designator (where appropriate);
- c) Current or passing level; **PLUS**
- d) Initial climb level (i.e. the first level at which the aircraft will level off unless otherwise cleared. For example, on a Standard Instrument Departure that involves a stepped climb profile, the initial climb level will be the first level specified in the profile.)

 Westbury Departure, BIGJET 347,
BIGRO 5D, Passing Altitude 2300
feet climbing FL80

 BIGJET 347, Westbury, Roger

1.1.3 On departure from a UK aerodrome at which a maximum IAS restriction has been promulgated in SIDs, the crew of an aircraft who, for configuration reasons, find it necessary to request ATC to approve an acceleration to a minimum clean speed which is higher than the restricted value, may use phraseology shown in the following examples:







 Wrayton Control, BIGJET 347,
request (number) knots due
configuration

 BIGJET 347, (number) knots
approved
or,
BIGJET 347, no ATC speed
restriction
or,
BIGJET 347, negative, maintain 250
knots

 Speed (number) knots, BIGJET 347
or,
No speed restriction, BIGJET 347
or,
Maintaining 250 knots, BIGJET 347

1.1.4 Where it is necessary to request cancellation of the departure speed restriction for overriding safety reasons other than aircraft configuration, pilots should request this in plain language according to the specific circumstances.

- 1.1.5 In addition to the ATC route clearance, departing IFR flights may be given additional instructions to provide separation in the immediate vicinity.

 BIGJET 347, Stourton Approach, continue heading 040 degrees until passing FL70 then route direct Wicken	 Heading 040 degrees until passing FL70 then direct Wicken, BIGJET 347
	 BIGJET 347, report passing FL70
	 BIGJET 347, passing FL70 routeing direct Wicken
	 BIGJET 347, contact Wrayton Control 129.1
	 Wrayton Control 129.1, BIGJET 347

1.2 VFR Departures

- 1.2.1 Departing VFR flights, when handled by approach control, may be passed information on relevant known traffic in order to assist the pilot in maintaining his own separation. Pilots should report leaving the area of jurisdiction of the approach control units.

 Borton Approach, G-CD, passing the zone boundary	 G-CD, Basic Service available from Wrayton 125.750
	 Wrayton Information 125.750, G-CD

- 1.2.2 Special VFR flights will be given specific instructions in the clearance to leave the control zone.

 G-CD, cleared to the zone boundary, route via Whiskey, Special VFR not above altitude 1500 feet	 Cleared to the zone boundary, route via Whiskey, Special VFR not above altitude 1500 feet, G-CD
	 G-CD, correct

1.3 IFR Arrivals

1.3.1 Aircraft flying within controlled airspace will normally receive descent clearance to the clearance limit from the ACC prior to transfer to an approach control unit. On transfer to approach control further descent instructions may be given.

 Kennington Approach, BIGJET 347, descending FL90 information Charlie

 BIGJET 347, Kennington Approach, cleared direct to North Cross descend FL50

 Direct to North Cross descend FL50, BIGJET 347

1.3.2 Arriving IFR flights operating outside controlled airspace are not permitted to enter controlled airspace until cleared to do so. In the examples below the initial approach fix is Kennington NDB (or VOR), callsign KTN.

 Kennington Approach, BIGJET 347

 BIGJET 347, Kennington Approach, pass your message

 BIGJET 347, from Stourton 25 miles southeast Kennington IFR, FL125 estimating zone boundary 20 KTN 24 information Charlie

 BIGJET 347, cleared from 10 miles southeast of Kennington to KTN at FL60. Enter controlled airspace at FL85 or below















 Cleared from 10 miles southeast of Kennington to KTN at FL60. Enter controlled airspace southeast of Kennington at FL85 or below, BIGJET 347

 BIGJET 347, expect ILS approach runway 28 QNH 1011

 ILS runway 28 QNH 1011, Request straight in approach, BIGJET 347

 BIGJET 347, cleared straight in ILS approach runway 28, descend to altitude 3000 feet QNH 1011, report established on the localiser

 Cleared straight in ILS approach runway 28, descend to altitude 3000 feet QNH 1011, Wilco, BIGJET 347

	 BIGJET 347, established on the localiser
	 BIGJET 347, runway in sight
	 BIGJET 347, number 1 contact Tower 118.7
	 Number 1 Tower 118.7, BIGJET 347
 Kennington Tower, BIGJET 347	 BIGJET 347, Kennington Tower, report outer marker
	 BIGJET 347
 BIGJET 347, outer marker	 BIGJET 347, runway 28 cleared to land surface wind 280 8
	 Runway 28 cleared to land, BIGJET 347
 Kennington Approach, G-DCAB	 G-DCAB, Kennington Approach, pass your message
	 G-DCAB, PA 31 inbound from Stourton IFR FL80 estimate KTN 47 information Delta
	 G-AB, remain outside controlled airspace. Time is 41. Expect joining clearance at 44

NOTE: Where it is not practicable to provide an expected clearance time, e.g. where the instruction 'remain outside controlled airspace' is used by a ground station other than the controlling authority for the relevant controlled airspace, the time check and expected clearance time may be omitted.

 Remain outside controlled airspace, G-AB



G-AB, cleared from 10 miles southeast of Kennington to KTN at FL80



Cleared from 10 miles southeast of Kennington to KTN at FL80, G-AB



G-AB, expect ILS approach runway 28



G-AB



G-AB, descend to altitude 3000 feet QNH 1011



Descend to altitude 3000 feet QNH 1011, G-AB



G-AB, cleared ILS approach runway 28 report KTN outbound



Cleared ILS runway 28, Wilco, G-AB



G-AB, KTN outbound



G-AB, report procedure turn complete



Wilco, G-AB



G-AB, procedure turn complete localiser established



G-AB, report at outer marker



Wilco, G-AB



G-AB, outer marker



G-AB, number one, contact Tower 118.9



Tower 118.9, G-AB

NOTE: Pilots may be requested to change to tower frequency at any point on final approach.



G-AB, contact tower 118.9 for final approach

- 1.3.3 On occasions IFR aircraft do not complete the instrument approach procedure but request permission to make a visual approach.



G-AB, over KTN 3000 feet field in sight, request visual approach



G-AB, cleared visual approach runway 28



Cleared visual approach runway 28, G-AB

- 1.3.4 Normally a holding procedure is published. However, the pilot may require a detailed description of a specific holding procedure.



BIGJET 347, hold at North Cross FL60 expect onward clearance at time 40



Hold at North Cross FL60, request holding instructions, BIGJET 347



BIGJET 347, hold at North Cross FL60 inbound track 260 degrees turns left outbound time 1 minute

It should be noted that the above information is passed in the following order and is for holds **other** than VOR/DME:

- Fix
- Level
- Inbound track
- Right or left turns
- Time of leg

- 1.3.5 Holding information for VOR/DME substitutes DISTANCE for TIME in e) above:













BIGJET 347, request holding instructions



BIGJET 347, hold on the Marlow VOR/DME at 20 DME FL100 inbound track 260 degrees turns left, limiting outbound distance 24 DME

1.4 VFR Arrivals

- 1.4.1 Depending on the procedures in use, the pilot of an arriving VFR flight may be required to establish contact with the approach control unit and request instructions before entering its area of jurisdiction e.g. before entering a control zone. Where there is an ATIS broadcast the pilot should acknowledge that he has received it; where no ATIS broadcast is provided the approach controller will pass the aerodrome data.

 Kennington Approach, G-DCDN, Request join	 G-DCDN, Kennington Approach pass your message
	 G-DCDN, C172 inbound from Stourton VFR 2500 feet Wessex 1011 estimating zone boundary 52 Kennington 02 information golf
	 G-DN, cleared from the zone boundary to Kennington VFR, not above 2500 feet Kennington QNH 1012. Traffic is a southbound Cherokee last reported 2000 feet VFR estimating zone boundary 53
	 Cleared from the zone boundary to Kennington VFR at 2500 feet QNH 1012, traffic in sight, G-DN
	 G-DN, report aerodrome in sight
	 Wilco, G-DN
	 G-DN, aerodrome in sight
	 G-DN, contact Tower 118.5
	 Tower 118.5, G-DN

NOTE: The phraseology for joining the aerodrome traffic circuit is detailed in Chapter 4, paragraph 1.8.

- 1.4.2 Instructions issued to VFR flights in class D airspace may comprise routeing instructions, visual holding instructions, level restrictions and information on collision hazards in order to establish a safe, orderly and expeditious flow of traffic. Where the controller requires a VFR aircraft to hold at a specific point pending further clearance, the controller will state this explicitly to the pilot. In the interests of shared understanding among pilots and controllers, the term 'clearance limit' is defined in the Glossary, but is not to be used as a phrase to delineate a restriction to a clearance.

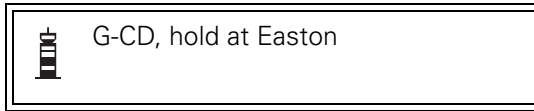

- 1.4.3 Where there is a need for some mutual flexibility to facilitate a flight within controlled airspace, e.g. a non-standard flight (NSF) or police flight, the controller may instruct the pilot to remain within a specified area.

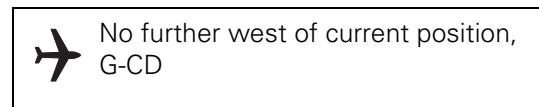
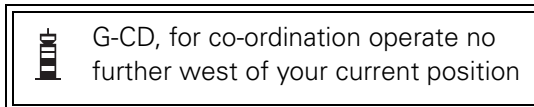
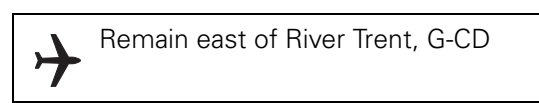
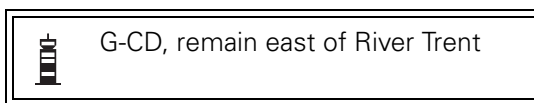

1.5 Special VFR Flights

- 1.5.1 Special VFR clearances are only issued for flights within Control Zones and are normally at the request of the pilot. The pilot:

- a) must comply with ATC instructions;
- b) is responsible for ensuring that his flight conditions enable him to remain clear of cloud, determine his flight path with reference to the surface and to keep clear of obstructions;
- c) is responsible for ensuring that he flies within the limitations of his licence;
- d) is responsible for complying with the relevant low flying restrictions of Rules 5 and 6 of the Rules of the Air Regulations.

NOTE: Whilst the 1000 ft rule may not apply to a pilot in receipt of a Special VFR clearance, the 'alight clear' rule always applies.

The responsibility to determine whether to accept a Special VFR clearance and still comply with this rule rests with the pilot;

- e) is responsible for avoiding aerodrome traffic zones unless prior permission for penetration has been obtained from the relevant ATSU.
- 1.5.2 A full flight plan is not required for Special VFR flight but the pilot must give brief details of the callsign, aircraft type and pilot's intentions, including ETA at entry point. A full flight plan is required if the pilot wishes his destination to be notified.
- 1.5.3 Aircraft are not normally given a specific height to fly but vertical separation from aircraft flying above can be achieved by requiring the Special VFR flight to fly not above a specified level (paragraph d) above must be borne in mind by pilots).
- 1.5.4 No separation will be provided between Special VFR flights which are flying in notified areas or routes where an individual clearance is not required, or between flights using such areas or routes and other flights on Special VFR clearances. Full details of the procedures for Special VFR flights appear in the UK AIP, ENR, 1.2.

1.6 **Vectoring to Final Approach**

- 1.6.1 Radar vectors are given to arriving flights to position them onto a pilot interpreted approach aid, to a point from which a radar-assisted approach can be made or to a point from which a visual approach is made.
- 1.6.2 MLS equipment will provide an “ILS look-a-like” straight in approach and the terms “Localiser” and “Glidepath” are retained. Due to the possibility of confusion between the words “ILS” and “MLS”, an MLS approach is referred to as a “Microwave Approach” in RTF communication.
- 1.6.3 In the following example an identified aircraft inbound to Kennington is given radar vectors to the ILS. Where applicable “Microwave” is shown (in brackets) to indicate appropriate MLS phraseology.

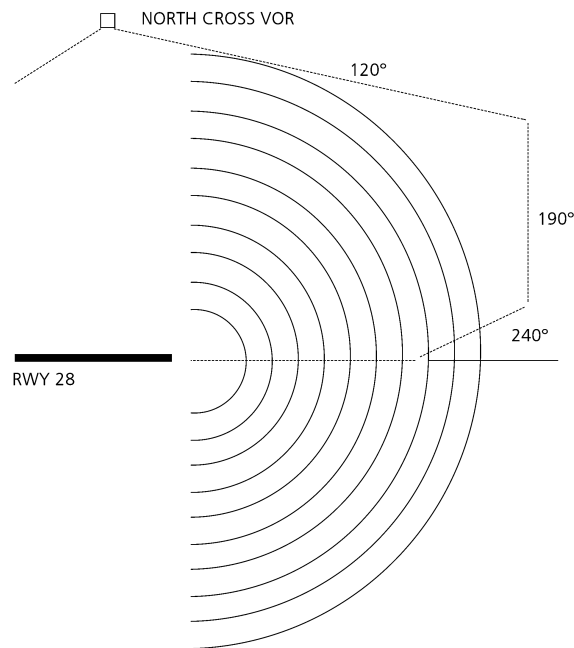









Figure 1 Radar vectors to an ILS approach

 Kennington Approach, BIGJET 347, FL60 information golf	 BIGJET 347, Kennington Approach, vectoring for ILS (or Microwave) approach runway 28
	 BIGJET 347
 BIGJET 347, leave North Cross heading 120 degrees	 Leave North Cross heading 120 degrees, BIGJET 347
 BIGJET 347, report speed	 BIGJET 347, speed 260 knots
	 BIGJET 347, for spacing reduce speed to 210 knots



210 knots, BIGJET 347



BIGJET 347, leaving North Cross heading 120 degrees



BIGJET 347, Roger, descend to altitude 2500 feet QNH 1011 number 4 in traffic



Descend to altitude 2500 feet QNH 1011, BIGJET 347



BIGJET 347, position 10 miles northeast of Kennington. This is a right hand circuit for runway 28.



BIGJET 347



BIGJET 347, turn right heading 190 degrees base leg, no ATC speed restrictions



Right heading 190 degrees. No speed restriction, BIGJET 347

NOTE: The following two ground station instructions may be given in more than one transmission. Controllers may additionally use the phrases 'Report established on localiser' or 'Report established on glidepath' where it is judged that this will aid situational awareness.



BIGJET 347, 12 miles from touchdown turn right heading 240 degrees closing localiser from the right. When established on localiser, descend on glidepath QNH 1011



Right heading 240 degrees when established on localiser, descend on glidepath QNH 1011, BIGJET 347



BIGJET 347, contact Tower 118.5





Tower 118.5, BIGJET 347

- 1.6.4 In the example above the approach speed of the aircraft is reduced to maintain separation between aircraft in an approach sequence. Where speed adjustment would be insufficient, it may be necessary to issue additional vectors.



 BIGJET 347, for spacing make a 360 turn left	 360 turn left, BIGJET 347
 BIGJET 347, for spacing turn left heading 220 degrees	 Left heading 220 degrees, BIGJET 347

NOTE: 360 spoken as "TREE SIXTY"





- 1.6.5 Where it is necessary, e.g. for traffic separation purposes, to ensure that an aircraft joining the ILS does not commence descent until specifically cleared, the controller may use the following alternative form of phraseology:

 BIGJET 347, (vectoring instructions as above) ... report established on localiser, maintain (level)	 (Readback of vectoring instructions) ... report established on localiser, maintaining (level), BIGJET 347
	 Localiser established, BIGJET 347

When the reason for restricting level no longer exists:

 BIGJET 347, descend on glidepath, QNH 1011	 QNH 1011, descend on glidepath, BIGJET 347
--	--

If it is necessary to vector an aircraft through the final approach track before subsequently joining the approach from the opposite side, the controller shall advise the pilot prior to the aircraft passing through the final approach track.

 BIGJET 347, this turn will take you through ILS for spacing	 BIGJET 347
 BIGJET 347, taking you through ILS for spacing	 BIGJET 347

- 1.6.6 Military ILS phraseology appears in Chapter 10 paragraph 3.13.

1.7 Direction Finding (DF)







1.7.1 The aeronautical stations that offer a VHF Direction Finding (VDF) service are listed in the UK AIP AD. Some VDF stations stipulate that the service is not available for en-route navigation purposes (except in emergency). VDF bearing information will only be given when conditions are satisfactory and radio bearings fall within calibrated limits of the station. If the provision of a radio bearing is not possible the pilot will be told of the reason.

A pilot may request a bearing or heading using the appropriate phrase or Q code to specify the service required. Each aircraft transmission shall be ended by the aircraft call sign. A VDF station will provide the following as requested:

- QDR – Magnetic bearing of the aircraft from the station (i.e. Approach G-ABCD request QDR G-ABCD).
- QDM – Magnetic heading to be steered by the aircraft (assuming no wind) to reach the VDF station (i.e. Approach G-ABCD request QDM G-ABCD).
- QTE – True bearing of the aircraft from the station (i.e. True bearing, True bearing Approach G-ABCD request True bearing (or QTE) G-ABCD).

The direction-finding station will reply in the following manner:

- The appropriate phrase or Q code.
- The bearing or heading in degrees in relation to the direction finding station.
- The class of bearing (Class may be omitted after passing the initial bearing).
- The time of observation, if necessary.

 Kennington Approach, G-ABCD, request QDM G-ABCD	 G-ABCD, Kennington Approach, QDM 090 degrees class Bravo
	 QDM 090 degrees class Bravo, G-ABCD
 True bearing, true bearing, Kennington Approach, G-ABCD, request true bearing, G-ABCD	 G-ABCD, Kennington Approach, true bearing 276 degrees true, I say again, 276 degrees true class bravo
	 True bearing 276 degrees class Bravo, G-ABCD

1.7.2 Controllers may request a pilot to make a transmission so that the DF bearing associated with the transmission may be observed.

 G-ABCD Kennington Approach, transmit for DF	 Transmit for DF, G-ABCD
---	---

1.7.3 The accuracy of the observation is classified as follows:





- Class A – Accurate within plus or minus 2 degrees
- Class B – Accurate within plus or minus 5 degrees
- Class C – Accurate within plus or minus 10 degrees
- Class D – Accuracy less than Class C

NOTE: Normally no better than Class B bearing will be available.







1.8 VDF Procedure













1.8.1 This is a procedure whereby a pilot requests a series of QDMs to home to a VDF station on or near an aerodrome and to carry out a prescribed VDF instrument approach procedure to the aerodrome. VDF procedures are notified in the AD section of the UK AIP.

1.8.2 Requests for QDMs are normally initiated by the pilot at intervals of about 1 minute during the initial stages of the homing, increasing in frequency as the VDF overhead is approached. During this procedure QDMs are requested as required to achieve and maintain the specified tracks. **The VDF Procedure is totally pilot interpreted.**

 Borton Approach, G-ABCD, information Delta, request homing and VDF approach	 G-ABCD, Borton Approach, pass your message
 G-ABCD, T67, 15 miles northwest of Borton, heading 130 degrees, FL55, IFR, inbound Borton, request homing and VDF approach, G-ABCD	 G-CD, cleared to the VDF overhead at altitude 3000 feet Borton QNH 1010, QDM 125 class Bravo, report overhead
 Cleared to the VDF overhead at altitude 3000 feet Borton QNH 1010, QDM 125 class Bravo, Wilco, G-CD	

1.8.3 The pilot employs a series of QDMs to home to the VDF overhead positioning himself to arrive from a direction which will entail the minimum of manoeuvring in the overhead to proceed outbound on the specified track.

 G-CD, request QDM G-CD	 G-CD, QDM 125
 QDM 125, G-CD	 G-CD, maintaining 3000 feet, request QDM G-CD
 G-CD, Roger, QDM 135	 QDM 135, G-CD

	G-CD, request QDM, G-CD
	G-CD, QDM 145, cleared VDF approach runway 34
	QDM 145, cleared VDF approach runway 34, G-CD
	G-CD, request QDM G-CD
	G-CD, QDM 155
	QDM 155, G-CD
	G-CD, request QDM G-CD
	G-CD, no bearing
	G-CD, request QDM G-CD
	G-CD, no bearing
	G-CD, overhead turning outbound
	G-CD, report descending in the procedure QNH 1010
	Wilco, QNH 1010, G-CD

- 1.8.4 The pilot starts timing the outbound leg and, employing a series of QDMs to establish and maintain the prescribed track, descends as notified for the procedure. The timed outbound leg ends with a turn (normally level) onto the final approach QDM.

	G-CD, request QDM, G-CD
---	-------------------------

 G-CD, QDM 345

 G-CD, descending outbound QDM 345, G-CD

 G-CD, Roger, report base turn complete

 Wilco, G-CD

 G-CD, request QDM, G-CD

 G-CD, QDM 355

 QDM 355, G-CD

1.8.5 At the end of the outbound leg the pilot turns as prescribed onto the final approach QDM using a series of QDMs during the turn to achieve the final QDM.

 G-CD, request QDM, G-CD

 G-CD, QDM 345

 QDM 345, G-CD

 G-CD, request QDM, G-CD

 G-CD, QDM 342

 QDM 342, G-CD

 G-CD, base turn complete, descending inbound, G-CD

 G-CD, continue approach, report visual QNH 1011

 G-CD, Wilco, QNH 1011, request QDM, G-CD

 G-CD, QDM 338

 QDM 338, G-CD

 G-CD, request QDM, G-CD

 G-CD, QDM 342

 QDM 342, G-CD

 G-CD, visual

 G-CD, contact Tower 118.7

 Tower 118.7, G-CD

1.8.6 If no visual contact is gained, a missed approach is initiated at the missed approach point which is normally the VDF overhead.









 G-CD, request QDM G-CD

 G-CD, no bearing

 G-CD, nothing seen, going around

1.9 NDB(L) and VOR Procedures

1.9.1 NDB(L) and VOR instrument approach procedures are pilot interpreted procedures notified for particular aerodromes and runways where procedural tracks are defined by NDB(L) bearings or VOR radials. Some NDB(L) and VOR procedures may include marker beacons or DME to provide ranging information. Aircraft may also be radar vectored to an NDB(L) or VOR final approach track. An example of a typical NDB(L) instrument approach procedure to an aerodrome outside controlled airspace follows; similar RTF phraseology may be employed in VOR procedures.

 Borton Approach, G-ABCD, inbound Borton, information Delta	 G-ABCD, Borton Approach, pass your message
	 G-ABCD, T67, 20 miles south of Borton, FL80, IFR, estimating BTN 47, request NDB/DME approach
	 G-CD, cleared to BTN at FL80, expect NDB/DME approach RW 34, expected approach time 58
	 Cleared to BTN FL80 to hold. Expected approach time 58, G-CD
	 G-CD, descend to altitude 3000 feet, Borton QNH 1015, report entering the hold
	 Descend to altitude 3000 feet Borton QNH 1015, wilco, G-CD
	 G-CD, overhead the BTN, maintaining 3000 feet entering the hold
	 G-CD

NOTES:

- 1 All manoeuvres associated with entering the holding pattern are considered to be part of the holding procedure.
- 2 Aircraft engaged in holding for training purposes should notify the controller on the commencement of the penultimate hold, e.g. 'G-CD on completion of this hold, request commence approach'.

 G-CD, cleared NDB/DME approach runway 34, report beacon outbound
--

 Cleared for NDB/DME approach
runway 34, Wilco, G-CD

 G-CD, beacon outbound

NOTE: Beacon outbound should be called only at the final passage over the beacon when commencing the outbound portion of the procedure.

 G-CD, report base turn complete,
QNH 1015

 Wilco, QNH 1015, G-CD

 G-CD, base turn complete

 G-CD, report at 4 DME

 Wilco, G-CD

 G-CD, 4 DME

 G-CD, Roger, contact Tower 118.7

 Tower 118.7, G-CD

Figure 2 Join and hold for non-precision approach**Figure 3** Procedure**RTF for a Non-precision Approach**

- Position 1:** Pilot transmits callsign, aircraft type, position, flight level, flight conditions, estimate for the beacon and requests type of approach required.
- Position 2:** When overhead the beacon, pilot reports '**Callsign, entering the hold, maintaining (altitude/flight level)**'.
- Position 3:** Pilot reports '**Callsign, beacon outbound**' (in Figure 2 when overhead the beacon).
- Position 4:** Pilot reports '**Callsign, base turn complete**'.
- Position 5:** Pilot reports '**Callsign, 4 DME**' (or other position as required).

Figure 4 Alternative procedure

1.10 Area Navigation Global Navigation Satellite System RNAV (GNSS) Phraseology

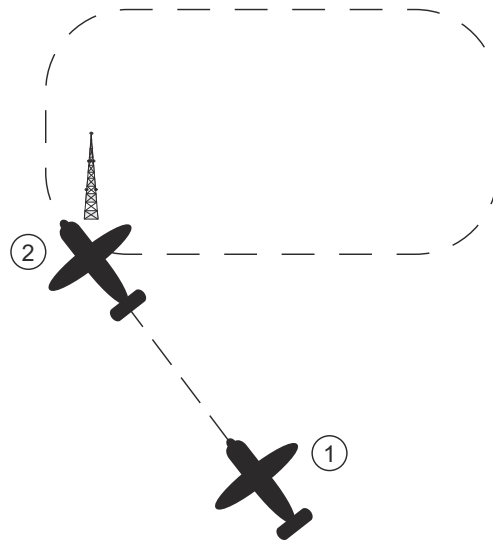
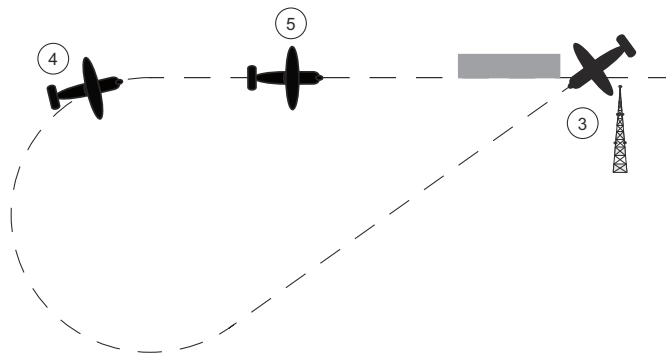
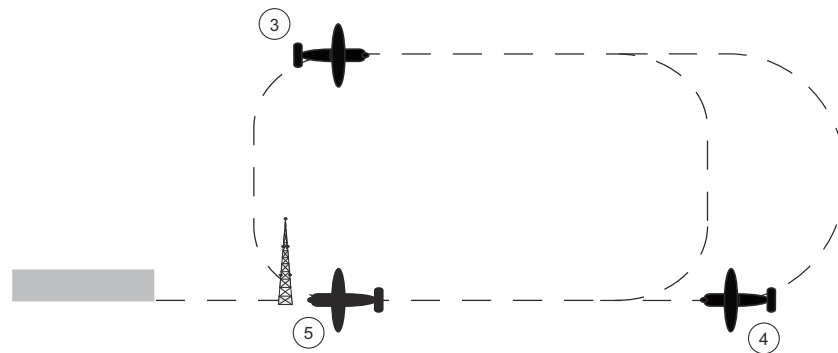
1.10.1 Pilot-interpreted RNAV (GNSS) instrument approach procedures are available for use by suitably equipped aircraft at certain aerodromes. The phraseology to be used is illustrated in the following examples:

1.10.2 Procedure Clearance

1.10.2.1 Clearance to fly the approach should be requested using the initial approach fix and runway designator:

 G-ABCD, request RNAV approach
via BEMBO, Runway 27

1.10.2.2 Where traffic conditions permit, controllers shall clear the pilot to follow the procedure, indicating the runway designator and initial approach fix to be used:

 G-ABCD, cleared RNAV approach
Runway 27, report at BEMBO.

1.10.3 Position Reporting

1.10.3.1 For traffic sequencing and to aid situational awareness, controllers may request the pilot to report when established on final approach track or to report at any other relevant point in the procedure, as shown below and overleaf, respectively:

 G-CD, report established on final
approach track

 G-CD, report 2 miles from final
approach fix

1.10.4 Final Approach Fix

Controllers will instruct the pilot to report at the final approach fix:

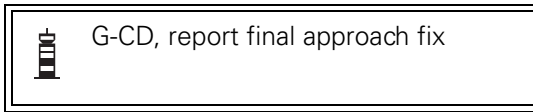

1.10.5 Reporting GNSS Problems

1.10.5.1 When aware of problems with the GNSS system, controllers will notify the pilot specifying, where known, applicability in terms of type of operation, location, geographical boundaries and times:

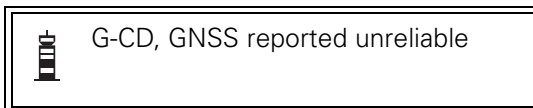

or,

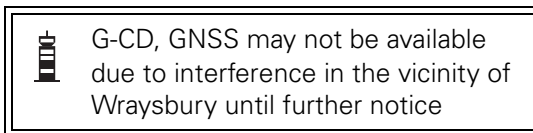

1.10.5.2 A RAIM (Receiver Autonomous Integrity Monitoring) alert indicates to the pilot that the GNSS system is unavailable either due to insufficient satellites in view or a fault in the system; in these cases the pilot will break off the approach. Following a RAIM indication, pilots shall inform the controller of the event together with their intentions.

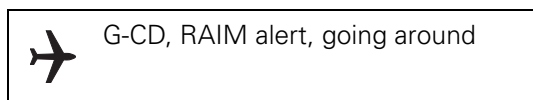
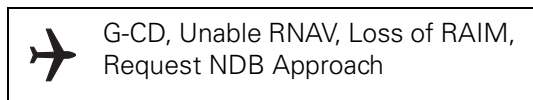

1.11 Surveillance Radar Approach (SRA)



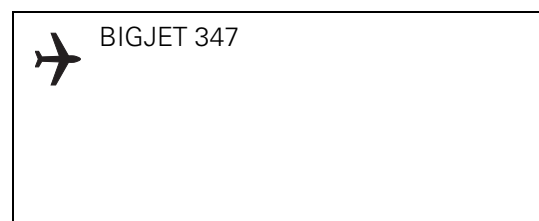
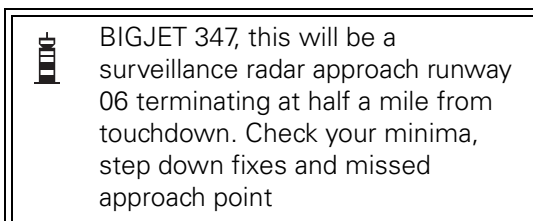















1.11.1 During a surveillance radar approach (SRA) the pilot is given distances from touchdown, advisory altitude information and azimuth instructions to enable him to make an approach to a particular runway.









NOTE: Where step down fixes do not exist in local SRAs, approval for a modified RTF procedure may be sought from the CAA's Air Traffic Standards Division.







1.11.2 Unless offered by the controller or local procedures require, a pilot wishing to conduct his approach by reference to height must inform the controller and request the QFE. All references to the level of the aircraft will then be to height.











- 1.11.3 Pilots conducting an approach based on QNH shall be passed the aerodrome/ threshold elevation before commencing the final descent.
- 1.11.4 If the pilot reports visual in the early stages of the approach he will be asked whether he wishes to continue the SRA. Normally aircraft will not be transferred to aerodrome control until after they have completed the SRA approach and have landed.
- 1.11.5 The range at which the descent begins depends on the altitude or height of the aircraft during the intermediate phase and the angle of the glide path.

 BIGJET 347, this will be a surveillance radar approach, runway 28 terminating at (number) miles from touchdown. Check your minima, step down fixes and missed approach point	 BIGJET 347
 BIGJET 347, QNH 1003, threshold elevation 196 feet	 QNH 1003, threshold elevation 196 feet, BIGJET 347
 BIGJET 347, turn right heading 275 closing final approach	 Right heading 275, BIGJET 347
 BIGJET 347, (number) miles from touchdown. Your descent will begin at (number) miles. Check gear	 BIGJET 347
 BIGJET 347, (number) miles from touchdown. Report runway lights in sight	 BIGJET 347
 BIGJET 347, after landing contact Kennington tower on 118.5	 After landing Kennington tower 118.5, BIGJET 347
 BIGJET 347, approaching (number) miles from touchdown. Commence descent now to maintain a (number) degree glide path	 Descending, BIGJET 347
 (number) miles from touchdown. Altitude (<i>or height</i>) should be (number) feet	 BIGJET 347
 Slightly left of track closing slowly/ quickly/rapidly/nicely from the left. Turn right heading 280	 Heading 280 BIGJET 347

 (number) miles from touchdown. Altitude (<i>or height</i>) should be (number) feet	 BIGJET 347
 (number) miles from touchdown. Altitude (<i>or height</i>) should be (number) feet. Heading 280 is good	 BIGJET 347
 (number) miles from touchdown. Altitude (<i>or height</i>) should be (number) feet. Slightly right of track closing from the right. Turn left 3 degrees heading 277	 Heading 277, BIGJET 347
 (number) miles from touchdown. Altitude (<i>or height</i>) should be (number) feet. Do not reply to further instructions	

(The gap between further transmissions will be less than 5 seconds.)

 (number) miles from touchdown. Altitude (<i>or height</i>) should be (number) feet. Runway 28 cleared to land. Surface wind calm
 (number) miles from touchdown. Altitude (<i>or height</i>) should be (number) feet. Heading 277 is good
 (number) miles from touchdown. Altitude (<i>or height</i>) should be (number) feet. On track
 (number) miles from touchdown. Altitude (<i>or height</i>) should be (number) feet. Check minimum descent height
 (number) miles from touchdown. Altitude (<i>or height</i>) should be (number) feet. On track
 (number) mile from touchdown. Altitude (<i>or height</i>) should be (number) feet
 On track. Half a mile from touchdown. Approach completed. Out

	Traffic Service, G-CD
	G-CD, cleared to cross the Greenfield Zone, routing via Hampton and Littleton, VFR not above altitude 2500 feet Greenfield QNH 1002
	Cleared to cross the Greenfield Zone routing via Hampton and Littleton, VFR not above altitude 2500 feet Greenfield QNH 1002, G-CD
	G-CD, report at Hampton
	Wilco, G-CD
	G-CD, overhead Hampton
	G-CD, Roger, report at Littleton
	G-CD, overhead Littleton
	G-CD, Roger, leaving controlled airspace Traffic Service Portland 1000
	Traffic Service, Portland 1000, G-CD

1.15 **Aerodrome Traffic Zone (ATZ) associated with another Aerodrome**

- 1.15.1 The legislation for flights within ATZs is contained in Rule 45 of the Rules of the Air Regulations. Controllers who are uncertain as to whether a pilot will either route around or transit through an ATZ for which they are not the controlling authority should advise the pilot of the ATZ status and confirm the pilot's intentions. Controllers may advise pilots to change to the published aerodrome frequency to either obtain ATZ crossing clearance from an ATC unit, or to obtain information from an AFIS or AGCS unit.

	G-CD, approaching Borton ATZ, confirm your intentions
---	---

	G-CD, approaching Seton ATZ, contact Seton Information frequency 122.775
---	--

1.16 Lower Airspace Radar Service (LARS)

1.16.1 LARS is an ATS surveillance service available to assist pilots flying outside controlled airspace up to and including FL95. LARS is normally provided within 30 NM of the nominated unit and is a secondary service provided at the discretion of the controller. Therefore, when primary task loadings are high, LARS may not be available. The service provided will be a Traffic Service or a Deconfliction Service

1.16.2 Details of ATSU's participating in the Lower Airspace Radar Service, hours of operation and contact frequencies, are published in the UK AIP (ENR 1.6.3, Lower Airspace Radar Service).

1.17 Air Traffic Services Outside Controlled Airspace (ATSOCAS)

1.17.1 Air Traffic Services outside Controlled Airspace (ATSOCAS) are provided by a variety of air traffic units and are detailed within CAP 774 (UK Flight Information Services) and in the UK AIP.

1.17.2 Pilots requiring ATSOCAS should establish RTF communication with the appropriate ATSU using the following format:

 Westbury Approach, G-ABCD, request Traffic Service

 G-ABCD, Westbury Approach, pass your message

1.17.3 Once communications have been established the pilot should pass the following details:

- a) Aircraft Callsign / Type
- b) Departure Point and Destination
- c) Present Position
- d) Level
- e) Additional details / Intention (e.g. Flight Rules, Next route point, Squawk Code)

 G-CD, Cessna 172, from Borton to Walden, 15 NM South of Westbury, altitude 2500 feet Wessex 1008, VFR, tracking to Wells, Squawking 7000

1.17.4 When an ATSOCAS is being provided, agreements can be established between a controller and a pilot on a short term tactical basis.

 G-CD, for co-ordination request maintain Flight Level 50















 Maintain Flight Level 50, G-CD

Or alternatively





 Negative, G-CD

 G-CD, for co-ordination request not above Flight Level 90

 Not above Flight Level 90, G-CD

 G-CD, for co-ordination request turn right heading 050 degrees	<p>Or alternatively</p>  Negative, G-CD
 G-CD, for co-ordination request route via Smallfield	 Turn right 050 degrees, G-CD
 G-CD, for co-ordination request operate no further west of your current position	<p>Or alternatively</p>  Negative, G-CD
 G-CD, gliding activity over Smallville	 Route via Smallfield, G-CD
 G-CD, multiple aircraft known to be operating 15 miles north of Smallville	<p>Or alternatively</p>  Negative, G-CD
 G-CD, PA28 estimating CPT at 25, altitude 2000 feet	 No further west of current position, G-CD
 G-CD, fast jet reported routing from Smallville to Midtown below altitude 500 feet	<p>Or alternatively</p>  Negative, G-CD

1.17.5 Phraseology used in surveillance derived traffic information and avoiding action is detailed in Chapter 5 paragraph 1.6. When providing a Basic Service, the controller may provide traffic information in general terms to assist with the pilot's situational awareness, using the following phraseology.

 G-CD, gliding activity over Smallville
 G-CD, multiple aircraft known to be operating 15 miles north of Smallville
 G-CD, PA28 estimating CPT at 25, altitude 2000 feet
 G-CD, fast jet reported routing from Smallville to Midtown below altitude 500 feet



G-CD, helicopter conducting power line inspection 5 miles north of Borton below altitude 500 feet

1.17.6 **Reduced Traffic Information**

1.17.6.1 When providing a surveillance derived ATS, there may be circumstances that prevent controllers from passing timely traffic information and/or deconfliction advice, e.g. high workload, areas of high traffic density, against aircraft conducting high energy manoeuvres, or when traffic is not displayed to the controller. Controllers shall inform the pilot of reductions in traffic information along with the reason and the probable duration; however, it may not always be possible to provide these warnings in a timely fashion.

1.17.6.2 In high workload situations, which may not always be apparent from RTF loading, it may not be possible for controllers to always provide timely traffic information and/or deconfliction advice. High workload situations may not necessarily be linked to high traffic density.



G-CD, reduced traffic information due to controller workload

1.17.6.3 High traffic density can cause difficulty interpreting ATS surveillance system data and may affect radiotelephony loading or controller workload to the extent that he is unable to pass timely traffic information and/or deconfliction advice on all traffic.



G-CD, approaching an area of high traffic density, possible late warning of traffic for the next 8 miles

1.17.6.4 Where aircraft are operating close to the lateral and/or vertical limits of solid ATS surveillance system cover, or close to a radar overhead, there is the potential for conflicting traffic to be detected late. Similarly, there is potential for aircraft to be undetected or detected late in known areas of poor surveillance performance, permanent echoes, weather clutter or when the controller suspects the performance of the ATS surveillance system is degraded.



G-CD, reduced traffic information from the left for the next 10 miles due to the limits of surveillance coverage

1.17.6.5 Where primary radar is unavailable, and SSR alone is used to provide an ATS, non-transpondering aircraft will not be detected. An SSR only service may be provided only if approved by the relevant authority.



G-CD, reduced traffic information, SSR only

1.17.6.6 Where the radar display is affected by clutter, the controller shall advise the pilot of the reduction in traffic information.

	G-CD, reduced traffic information from the left for the next 10 miles due displayed clutter
---	---

1.17.7 Traffic Service – Operations below ATC Terrain Safety Levels

1.17.7.1 If a pilot receiving a Traffic Service requests a heading from the controller whilst operating below the ATC unit terrain safe level, this may be provided as long as the controller reminds the pilot that they remain responsible for terrain clearance.

	G-CD, request a heading for Seaton
---	------------------------------------

	G-CD, taking your own terrain clearance, suggest right heading 120 degrees
---	--

	My own terrain clearance, right heading 120 degrees, G-CD
---	---

1.17.7.2 Other than when following a notified instrument flight procedure, a pilot requesting to descend below the ATC unit terrain safe level under a Traffic Service shall be reminded that he remains responsible for terrain clearance.

	G-CD, request descent to altitude 1000 feet
---	---

	G-CD, taking your own terrain clearance, descent approved
---	---

	My own terrain clearance, descent approved, G-CD
---	--

1.17.7.3 When providing a Traffic Service, levels allocated by controllers shall be terrain safe in accordance with ATC unit terrain safe levels, unless an agreement is reached with the pilot or such levels form part of VFR clearances for aerodrome arrival or to enter controlled airspace that by necessity require flight below the ATC unit terrain safe levels. In such circumstances, the instruction shall be accompanied by a reminder that the pilot remains responsible for terrain clearance.

	G-CD, for co-ordination can you accept flight at altitude 1500 feet
---	---

	Affirm, G-CD
---	--------------

	G-CD, taking your own terrain clearance, report level altitude 1500 feet
---	--

	My own terrain clearance, report level altitude 1500 feet, G-CD
---	---

1.17.8 Deconfliction Service – Descent below ATC Unit Terrain Safe Level

1.17.8.1 If a pilot requests descent below ATC unit terrain safe levels, controllers shall no longer provide a Deconfliction Service but should instead, subject to surveillance and RTF coverage, apply a Traffic Service.

 G-CD, request descent to altitude 1000 feet

 G-CD, Traffic Service, taking your own terrain clearance, descent approved

 Traffic Service, my own terrain clearance, descent approved, G-CD

1.17.9 Deconfliction Service – Departing and Arriving Aircraft

1.17.9.1 If a controller detects a conflict when an aircraft is below the ATC unit terrain safe level whilst departing from an aerodrome and climbing to the ATC unit terrain safe level, traffic information without deconfliction advice shall be passed. However, if the pilot requests deconfliction advice, or the controller considers that a definite risk of collision exists, the controller shall immediately offer such advice.

 G-CD, avoiding action with terrain alert, turn left immediately heading 180 degrees, traffic 12 o'clock, 5 miles opposite direction, indicating 2000 feet

1.17.9.2 If a controller detects a conflict when an aircraft is conducting a pilot interpreted instrument approach, controllers shall provide avoiding action advice and an associated terrain safe level to climb to or fly at.









 G-CD, avoiding action, turn left immediately heading 230 degrees, climb altitude 2000 feet, traffic 2 o'clock, 2 miles converging indicating 1000 feet

Chapter 7 Area Phraseology

1 Area Control Service Phraseology









1.1 General

The following examples of phraseology are suitable for use at area control centres according to the requirements of the prevailing traffic situation.

 BIGJET 347, request descent	 BIGJET 347, maintain FL280 expect descent after Marlow
	 Maintaining FL280, BIGJET 347
 BIGJET 347, descend FL120. Cross Colinton FL170 or above	 Descend FL120. Cross Colinton FL170 or above, BIGJET 347
 BIGJET 347, confirm able to cross Colinton at time 52	 Affirm, BIGJET 347
	 BIGJET 347, cross Colinton 52 or before
	 Cross Colinton 52 or before, BIGJET 347

1.2 Position Reporting

In order to assist in establishing separation, pilots may be instructed to provide additional position report information as well as routine reports.

 BIGJET 347, report Colinton	 Wilco, BIGJET 347
 BIGJET 347, Colinton 47 FL170 descending FL120, abeam KTN at 55	 BIGJET 347, Roger
 BIGJET 347, report 25 miles DME from Kennington	 Wilco, BIGJET 347
 BIGJET 347, report your DME distance from Kennington	 BIGJET 347, 26 miles

 BIGJET 347, report passing radial 270 Kennington VOR

 Wilco, BIGJET 347

1.3 Flights Joining Airways

- 1.3.1 Aircraft requiring to join an airway should make their request to the appropriate ATSU. Where no flight plan has been filed, the request should include the filing of an airborne flight plan (see Chapter 3). Where a flight plan has already been filed an abbreviated call may be made.

 Wrayton Control, G-RDVC, request clearance to enter controlled airspace northeast of Marlow at FL240 at time 42

 G-RDVC, cleared at time 42 from 8 miles northeast of Marlow to Colinton via A1, maintain FL240, squawk 5507

 Cleared at time 42 from 8 miles northeast of Marlow to Colinton, via A1, maintain FL240, squawk 5507, G-RDVC

 G-RDVC, correct

- 1.3.2 Because of the prevailing traffic situation, a joining clearance may not be issued immediately. Where it is not practicable to provide an expected clearance time, e.g. where the instruction 'remain outside controlled airspace' is used by a ground station other than the controlling authority for the relevant controlled airspace, the time check and expected clearance time may be omitted.

 G-RDVC, remain outside controlled airspace, expect joining clearance at time 55, time is 44

 Remaining outside controlled airspace, G-RDVC

- 1.3.3 In the event that the requested flight level is already occupied the controller will offer an alternative.

 G-RDVC, request FL240

 G-RDVC, unable approve FL240, FL220 available

 G-RDVC, accept FL220



1.4 Flights Leaving Airways

- 1.4.1 Flights leaving controlled airspace will normally be given a specific point at which to leave, together with any other relevant instructions necessary to ensure separation.

 G-RDVC, cleared to leave controlled airspace northeast of Marlow at FL220 whilst in controlled airspace

 Cleared to leave controlled airspace northeast Marlow at FL220 in controlled airspace, G-RDVC





1.4.2 An aircraft may request permission to leave controlled airspace by descent.

 G-RDVC, request permission to leave controlled airspace by descent	 G-RDVC, cleared to leave controlled airspace by descent. Report passing altitude 5500 feet Wessex 1014
 Cleared to leave controlled airspace by descent, will report passing altitude 5500 feet Wessex 1014, G-RDVC	

In the above example the base of the airway is 5500 feet.



1.5 Flights Crossing Airways

An aircraft requiring to cross an airway should make its request to the appropriate ATSU.

 Wrayton Control, G-ABCD, request crossing of A1 at Wicken	 G-ABCD, Wrayton Control, pass your message
 G-ABCD, T67 from Borton, 20 miles north of Wicken heading 220 FL80 IMC request crossing clearance of airway A1 at Wicken FL80 at 1033	
 G-ABCD, cleared to cross A1 at Wicken, maintain FL80 whilst in controlled airspace. Report entering the airway	
 Cleared to cross A1 at Wicken maintain FL80 in controlled airspace. Wilco, G-ABCD	

1.6 Flights Holding En-Route

When an aircraft is required to hold en-route, the controller will issue holding instructions and a time at which onward clearance can be expected. Where it is not self-evident, the reason for the delay should also be given.

 BIGJET 347, hold at Colinton FL170, expect onward clearance at 03, landing delays at Kennington 20 minutes	 Hold at Colinton FL170 expect onward clearance at time 03, BIGJET 347
--	---

1.7 Reduced Vertical Separation Minimum (RVSM) Phraseology

1.7.1 The following phraseology is applicable for RVSM operations:

Table 1

Message	Phraseology (italics indicates a pilot transmission)
To ascertain the RVSM approval status of a flight	CONFIRM RVSM APPROVED
Pilot indication of RVSM Approved status	<i>AFFIRM RVSM</i>
Pilot indication of non RVSM approval status	<i>NEGATIVE RVSM (supplementary information e.g. State aircraft)</i>
To deny ATC clearance into RVSM airspace	UNABLE ISSUE CLEARANCE INTO RVSM AIRSPACE, MAINTAIN [or DESCEND or CLIMB] (level)
For the case of an individual aircraft reporting severe turbulence or other severe weather related phenomenon	<i>UNABLE RVSM DUE TURBULENCE</i>
The phraseology required for a pilot to communicate those circumstances which would cause an aircraft's equipment to degrade to below altimetry Minimum Aircraft Systems Performance Specification (MASPS) compliance levels Note: The phrase is to be used to convey both the initial indication of the non-altimetry MASPS compliance and, henceforth, on initial contact on all frequencies within the lateral limits of the RVSM airspace until such time as the problem ceases to exist	<i>UNABLE RVSM DUE EQUIPMENT</i>
To request an aircraft provide information as soon as RVSM approved status has been regained or the pilot is ready to resume RVSM operations	REPORT WHEN ABLE TO RESUME RVSM
To request confirmation that an aircraft has regained RVSM approved status or the pilot is ready to resume RVSM operations	CONFIRM ABLE TO RESUME RVSM
The pilot shall communicate his/her ability to resume operation within the RVSM airspace after an equipment related contingency, or his/her ability to resume RVSM operations after a weather related contingency	<i>READY TO RESUME RVSM</i>

NOTE: Should there be reason to believe that an aircraft's declared RVSM status is in doubt, then the controller shall ask the RVSM status in accordance with in the table above.

Example: A non-RVSM compliant aircraft maintaining FL350 making an initial call on a new frequency:

Pilot: **(callsign)** MAINTAINING FL350, NEGATIVE RVSM

- 1.7.2 During operations in, or vertical transit through, reduced vertical separation minimum (RVSM) airspace with aircraft not approved for RVSM operations, pilots shall report non-approved status at initial call on any channel within RVSM airspace.
- 1.7.3 Air traffic controllers shall explicitly acknowledge receipt of messages from aircraft reporting RVSM non-approved status.

INTENTIONALLY LEFT BLANK

Chapter 8 Emergency Phraseology

1 Distress and Urgency Communication Procedures

1.1 Introduction

This Chapter describes the characteristics of the VHF International Aeronautical Emergency Service and equivalent services provided in the UK by Distress and Diversion (D&D) sections on UHF. It also describes the RTF procedures which should be used by civil pilots under the Aeronautical Mobile Service during an emergency in the UK. Additional information is published in the UK AIP (GEN) section and AICs.

1.2 States of Emergency

1.2.1 The states of emergency are classified as follows:

- a) *Distress* A condition of being threatened by serious and/or imminent danger and of requiring immediate assistance.
- b) *Urgency* A condition concerning the safety of an aircraft or other vehicle, or of some person on board or within sight, but does not require immediate assistance.

1.2.2 The pilot should start the emergency call with the appropriate international RTF prefix as follows:

- a) *Distress* 'MAYDAY, MAYDAY, MAYDAY'
- b) *Urgency* 'PAN PAN, PAN PAN, PAN PAN'

1.3 UHF and VHF Emergency Service

1.3.1 The UK has two Distress and Diversion (D&D) Sections located at the London and Scottish Area Control Centres. They are manned by RAF control staff who are assisted in the provision of an emergency service on the International Aeronautical Emergency Frequency 121.5 MHz and on 243.0 MHz by suitably equipped civil and military units and certain HM Coastguard stations. The service is available continuously to pilots flying within UK airspace who are in distress, in urgent need of assistance, or experiencing difficulties (i.e. temporarily unsure of position) which could lead to a state of emergency. The service may also be available for practices provided that no actual emergency is in progress on the UHF or VHF distress frequencies. More information on the emergency service for civil pilots can be found in the UK AIP (GEN).

1.3.2 The primary role of the D&D Sections is to provide military and civil pilots with an emergency aid and position fixer service. Autotriangulation (DF) coverage on 121.5 MHz is available over most of the London FIR above 3000 ft amsl to aircraft flying to the east and south of Manchester, apart from within approximately 40 NM of Heathrow, where coverage is available above approximately 2000 ft amsl. In respect of other civil aircraft incidents on VHF they rely for position fixing on DF bearing information obtained by telephone from external units equipped with VDF. This fixing procedure takes time and may require several minutes of concentrated activity because it involves the manual plotting onto 1:250,000 charts of the bearings received. The quality of the position fixes is determined by the availability of VDF bearings, and thus, depends largely on the height of an aircraft and its distance from the VDF stations. The coverage of the VHF fixing service is limited below 3000 ft amsl; indeed, the ability to locate aircraft at low altitude by the use of VDF may be severely inhibited (because of the effects of high ground) over much of Scotland,

Wales and SW England. In circumstances where 121.5 MHz DF data is lacking, the controller's ability to assist a pilot who is uncertain of his position is very limited, and will depend on such factors as the availability of SSR information and the amount and accuracy of the information provided by the pilot about his route, last known position and observed landmarks.

- 1.3.3 Certain UK aerodromes can also offer civil pilots an effective emergency communications and aid service. Some maintain a continuous watch on 121.5 MHz, but not all are equipped with VDF or SSR. Others do not normally listen out on 121.5 MHz but they do have VDF and may be asked by the Emergency Controller to provide DF bearing information on an aircraft, and other assistance. Where a bearing is required for fixing purposes from an airfield which has VDF but not on 121.5 MHz, the Emergency Controller may instruct the pilot to change temporarily to the frequency on which VDF is available.

1.4 **UHF and VHF Emergency Service – General Procedures**

- 1.4.1 Pilots should address their emergency calls on 121.5 MHz or 243.0 MHz to 'London Centre' when south of N55°, and 'Scottish Centre' when north of N55°. If doubt exists about the appropriate centre, it is not necessary to address a specific station. Once two-way communication has been established, pilots should not leave 121.5 MHz or 243.0 MHz without telling the controller. The use of special D&D Sections at the ACCs in the provision of emergency services is unique to the UK. Detailed information on related UK Search and Rescue (SAR) procedures is contained in the GEN Section of the UK AIP.
- 1.4.2 Pilots are urged – in their own interests – to request assistance from the emergency service as soon as there is any doubt about the safe conduct of their flight. Even then, the provision of assistance may be delayed if a pilot does not pass clear details of his difficulties and requirements, using the international standard RTF prefix 'MAYDAY, MAYDAY, MAYDAY' or 'PAN PAN, PAN PAN, PAN PAN' as appropriate. For example, a vague request from a pilot for 'confirmation of position' is unlikely to be accorded as much priority as would be given to a statement that he is lost. If, subsequent to the transmission of a 'MAYDAY' or 'PAN', a pilot considers the problem not to be as serious as first thought and priority attention is no longer required, the emergency condition may be cancelled at the pilot's discretion. It is invariably preferable for pilots believing themselves to be facing emergency situations to declare them as early as possible and then cancel later if they decide the situation allows.
- 1.4.3 If a pilot is already in communication with a civil or military ATSU, before the emergency arises, assistance should be requested from the controller on the frequency in use. In this case, any SSR code setting previously assigned by ATC (other than the Conspicuity Code 7000) should be retained until instructions are received to change the code setting.
- 1.4.4 If, however, the pilot is not in direct communication with an ATSU and the aircraft is equipped with an SSR transponder it should be switched, preferably before the emergency call is made, to Emergency Code 7700, with Mode C if available. If the transponding aircraft is high enough to be within secondary radar cover, the selection of the Emergency 7700 Code will alert the Emergency Controller to the presence of an incident by means of an audio and visual warning. The received SSR plot will show the precise location of the aircraft on the controller's radar display, and will then obviate the need for the emergency controller to carry out the more time-consuming manual aircraft position plotting procedure. Information on SSR operating procedures, including Special Purpose Codes 7700 (Emergency), 7600 (Radio Failure) and 7500 (Hijack or Other Act of Violence) are detailed in the ENR Section of the UK AIP.

- 1.4.5 If no acknowledgement of the distress or urgency message is made by the station addressed by the aircraft, other stations shall render assistance. Due to the nature of distress and urgency situations, the originator of messages addressed to an aircraft in distress or urgency condition shall restrict to the minimum the number and volume and content of such messages as required by the condition.
- 1.4.6 Following the initial distress or urgency message, it is permissible for pilots and controllers to use 'MAYDAY' and 'PAN' as a callsign prefix at their discretion, where it is judged that this would have a beneficial effect on the outcome.





1.5 **Emergency Message**

The emergency message shall contain the following information (time and circumstance permitting) and, whenever possible, should be passed in the order given:

- a) 'MAYDAY/MAYDAY/MAYDAY' (or 'PAN PAN/PAN PAN/PAN PAN');
- b) Name of the station addressed (when appropriate and time and circumstances permitting);
- c) Callsign;
- d) Type of aircraft;
- e) Nature of the emergency;
- f) Intention of the person-in-command;
- g) Present or last known position, flight level/altitude and heading;
- h) Pilot qualifications (See Note 1), viz:
 - i) Student pilots (see Notes 2 and 3);
 - ii) No Instrument Qualification;
 - iii) IMC Rating;
 - iv) Full Instrument Rating.
- i) Any other useful information e.g. endurance remaining, number of people on board (POB), aircraft colour/markings, any survival aids.

NOTES:

- 1 There is no ICAO requirement to include pilot qualifications in a distress message. However, this information should be included whenever possible in UK emergency messages as it may help the controller to plan a course of action best suited to the pilot's ability.
- 2 Solo student pilots shall prefix the aircraft callsign with 'STUDENT', e.g. 'MAYDAY, MAYDAY, MAYDAY STUDENT G-ABCD ... ' to indicate their lack of experience. (See Chapter 11, Phraseology Examples, paragraph 1.7.)
- 3 Although intended primarily for use by ab initio students, the prefix shall also be used in other circumstances where, for example, the holder of a valid licence is returning to flying practice after a significant absence and is undergoing renewal training involving solo flight conducted as a student under the supervision of a flight instructor.
- 4 POB – Total number of People on Board.
- 5 Emergency messages by military pilots are different and are detailed in JSP 552 Section 700.

 <p>MAYDAY MAYDAY MAYDAY Milthorpe Tower, G-ABCD, Slingsby engine fire losing height intend an immediate forced landing 20 miles south of Milthorpe. Passing 3000 feet heading 360 degrees PPL no instrument qualification 1 POB</p>	 <p>G-ABCD, Milthorpe Tower, Roger MAYDAY (any pertinent information)</p>
 <p>MAYDAY MAYDAY MAYDAY Milthorpe Tower, G-ABCD, C172 engine failed. Will attempt to land Milthorpe, 10 miles south, 4000 feet heading 360 degrees, Student pilot</p>	 <p>G-ABCD, Milthorpe Tower, Roger MAYDAY cleared straight-in runway 35 wind 260 10 knots QFE 1008 you are number one</p>

1.6 Ejection from Aircraft

The phrase to advise a controller that a pilot is abandoning an aircraft equipped with an ejection seat:

 (Callsign), Ejecting

1.7 Speechless Code

- 1.7.1 If an emergency message received by the Military Emergency Controller is weak or distorted to the point of being unintelligible, the pilot may be asked to adopt the Speechless Code. A comprehensive description of the speechless procedure appears in Chapter 10 paragraph 3.16.
- 1.7.2 An aircraft SSR transponder can also be used, during times of communication difficulties, by a pilot to acknowledge or respond to messages by the transmission of SSR Code changes or squawking 'Ident' as requested by the controller.
- 1.7.3 If neither the state of DISTRESS nor URGENCY applies, a service is available at lower priority to pilots who find themselves in DIFFICULTY. Such pilots should make their situation clear and then provide as much information as possible to the emergency controller from the list at paragraph 1.5 a) to i).

1.8 Radio Procedures – Practice Emergencies

- 1.8.1 Pilots may simulate emergency incidents (BUT NOT THE STATE OF DISTRESS) on 121.5 MHz or 243.0 MHz to enable them to gain experience of the ATC service provided. Before calling, pilots should listen out on the emergency frequency to ensure that no actual or practice incident is already in progress. Practice calls need not disrupt a planned flight or involve additional expense in fuel or time since the pilot can request 'diversion' to his intended destination or cancel the exercise when necessary. Simulated emergency calls must be prefixed 'PRACTICE' and should be brief, e.g:

 PRACTICE PAN, PRACTICE PAN,
PRACTICE PAN, London Centre,
G-ABCD

The Emergency Controller will then indicate acceptance of the Practice Pan by transmitting:

	G-ABCD, London Centre, PRACTICE PAN acknowledged, pass details when ready
---	---

The Emergency Controller may instruct the pilot to call at another time, if the practice cannot be accommodated.

- 1.8.2 If a practice is accepted, the pilot should then pass his details. SSR Code 7700 should *not* be selected during a practice emergency exercise unless required by the Emergency Controller. Mode C should be switched on, if available.

1.9 Training Fix

Pilots who do not wish to carry out a practice emergency but only wish to confirm their position for training purposes may request a 'Training Fix' on 121.5 MHz. This 'Training Fix' is secondary in importance to actual emergency calls but takes precedence over practice emergency calls in the event of simultaneous incidents. Pilots who are unsure of their position should state this and request a position fix or make a "PAN" call, rather than requesting a training fix.

(Listen out before transmitting)

	Training Fix, Training Fix, Training Fix, G-ABCD
---	---

	G-ABCD, Scottish Centre, your position indicates 7 miles south of Pitlochry
---	---

1.10 Relayed Emergency Message

Any aeronautical station or aircraft knowing of an emergency incident may transmit a distress message whenever such action is necessary to obtain assistance for the aircraft or vessel in distress. In such circumstances, it should be made clear that the aircraft transmitting is not itself in distress.

	MAYDAY MAYDAY MAYDAY Milthorpe Tower, G-ABCD, have intercepted MAYDAY from G-BJRD, I say again G-BJRD Cessna 172 engine failure forced landing 10 miles west of Wicken VOR, 1000 feet descending, heading 120, IMC rating, over
---	--

	G-ABCD, Milthorpe Tower, Roger your relayed MAYDAY from G-BJRD
---	---

1.11 Imposition of Silence

- 1.11.1 Transmissions from aircraft in distress have priority over all other transmissions. On hearing a distress call, all stations must maintain radio silence on that frequency unless the distress is cancelled or the distress traffic is terminated; all distress traffic has been transferred to other frequencies; the station controlling communications gives permission; it has itself to render assistance. Any station which has knowledge of distress traffic, and which cannot itself assist the station in distress, shall nevertheless continue listening to such traffic until it is evident that assistance is being provided. Stations should take care not to interfere with the transmission of urgency calls.

- 1.11.2 The aircraft in distress or the station in control of a distress incident may impose silence either on all stations in the area or on any particular station that interferes with distress transmissions. In either case, the message should take the following form:

 All stations, Milthorpe Tower, stop transmitting. MAYDAY

or,

 G-ABCD, stop transmitting. MAYDAY

- 1.11.3 The aeronautical station acknowledging a distress message on a particular frequency may consider it prudent to transfer other aircraft from that frequency in order to avoid any disruption of transmission from or to the emergency aircraft.

 MAYDAY, G-BJRD, remain this frequency, Break, Break, all other aircraft contact Milthorpe Tower on 123.825, out.

1.12 Emergency Descent

- 1.12.1 When an emergency descent is in progress controllers may broadcast an emergency message on appropriate frequencies to warn other aircraft. The broadcast may include specific instructions, clearances or traffic information as necessary.

 Attention all aircraft in the vicinity of Wicken, emergency descent in progress from FL310 passing FL230

 BIGJET 347, route direct Marlow

 Route direct Marlow, BIGJET 347

1.13 Termination of Distress Communications and of RTF Silence

- 1.13.1 When an aircraft is no longer in distress it shall transmit a message cancelling the emergency condition.

 Milthorpe Tower, G-BJRD, cancel MAYDAY, engine restarted, runway in sight. Request landing

 G-RD, runway 35 cleared to land. Surface wind 320 6

 Runway 35 cleared to land, G-RD

- 1.13.2 When an distress incident has been resolved, the station which has been controlling the emergency traffic will transmit a message indicating that normal working may be resumed.

 All stations, Milthorpe Tower, distress traffic ended

Chapter 9 Miscellaneous Phraseology

1 Other Communications

1.1 Wake Turbulence

- 1.1.1 ATC will provide the appropriate separation between IFR flights. When instructions are issued to regain wake turbulence separation, the controller shall use the following phraseology to make this apparent to the pilot.

 G-BJCD, for wake turbulence separation turn left heading 270 degrees

 Turning left heading 270 degrees, G-BJCD

- 1.1.2 If a pilot elects to execute a visual approach, or is arriving as a VFR flight, it is his responsibility to ensure an adequate distance from the preceding aircraft, although ATC will pass the appropriate distance.

 G-BJCD, caution wake turbulence the recommended distance is (number) miles

 G-BJCD

- 1.1.3 For departing flights ATC will issue take-off clearance when the required wake turbulence separation minima will be achieved. The minima to be applied at the time the aircraft are airborne is dependent on aircraft sequence, wake turbulence categories, and runway departure configuration.

 G-BJCD, Ready

 G-BJCD, Hold position, (number) minutes delay due to wake turbulence

 Holding, G-BJCD

1.2 Wind Shear

When wind shear is forecast or is reported by aircraft, ATC will warn other aircraft until such time as aircraft report the phenomenon no longer exists.

 G-CD, at 0745 a departing B757 reported windshear at 800 feet. Airspeed loss 20 knots, strong right drift

1.3 **AIRPROX Reporting**

- 1.3.1 An AIRPROX Report should be made by any pilot flying in the United Kingdom Flight Information Region, the Upper Flight Information Region or Shanwick Oceanic Area when in his opinion, the distance between aircraft as well as their relative positions and speed have been such that the safety of the aircraft involved was or may have been compromised.
- 1.3.2 The initial report is made by RTF to the ATSU in communication with the aircraft except that if the controllers workload is such that he is not able to accept the report the pilot will be requested to file details after landing.
- 1.3.3 The Pilot's RTF report should commence with words 'AIRPROX REPORT' and should include the following items:
- Aircraft Callsign
 - SSR Code
 - Position of AIRPROX
 - Aircraft heading
 - Flight level, altitude or height
 - Altimeter setting
 - Aircraft attitude (level/climbing/descending/turning)
 - Weather conditions
 - Date and time (UTC) of the AIRPROX
 - Description of other aircraft
 - First sighting distance and details of flight paths of reporting and reported aircraft.
- 1.3.4 RTF AIRPROX reports are to be confirmed in writing within seven days of the incident to allow follow up action to be taken. (See UK AIP ENR Section.)

1.4 **Oil Pollution Reporting**

Pilots sighting substantial patches of oil are requested to make reports by RTF to the ATSU with whom they are in communication or the appropriate FIS in order that action can be taken.

The RTF reports should contain the following:

'OIL POLLUTION REPORT' or 'POLLUTION REPORT'

- ... Time and date (if required) pollution was observed and identify of reporting aircraft.
- ... Position and extent of pollution
- ... Tide, windspeed and direction
- ... Weather conditions and Sea state
- ... Characteristics of pollution
- ... Name and nationality or description, including any distinctive markings, of any vessel seen discharging oil or other harmful substances; also estimated course and speed of vessel and if pollution is observed ahead of the discharging ship and the estimated length of pollution in her wake
- ... Identity of any other vessels in the immediate vicinity
- ... Whether photographs taken.

1.5 **Interceptions by Military Aircraft**

Pilots are warned that should they become involved in an interception by military aircraft they should follow the international procedures as detailed in the UK AIP ENR Section.

1.6 **Aircraft Operating Agency Messages**

1.6.1 **Introduction**

An aeronautical radio station which is licensed and established for company operational control communications (OPC) may be used only for communication with company aircraft or aircraft for which the company is the operating agency. A radio operator's certificate of competence issued by the UK CAA is not required for the use of this radio station.

1.6.2 **Limitations**

Personnel authorised to use an aircraft operating agency radio must not hold themselves out as providing an air traffic control service, i.e. they must not pass instructions to aircraft which could be construed in any way to be such a service. Similar constraints apply with regard to flight information services provided by an FISO for specific ground movements at aerodromes. Flight safety messages must be confined to messages originated by the agency which are of immediate concern to an aircraft in flight or just about to depart. This may include meteorological information.

1.6.3 Aircraft operating agency radio stations may only transmit and receive flight regularity and flight safety messages.

1.6.4 Air traffic service units using direct pilot-controller communication channels shall only be required to handle flight regularity messages provided this can be achieved without interference with their primary role and no other channels are available for the handling of such messages.

1.6.5 Flight regularity messages comprise the following:

- a) Messages regarding the operation or maintenance of facilities essential for the safety or regularity of aircraft operation;
- b) Messages concerning the servicing of aircraft;
- c) Instructions to aircraft operating agency representatives concerning changes in requirements for passengers and crew caused by unavoidable deviations from normal operating schedules. Individual requirements of passengers or crew are not admissible in this type of message;
- d) Messages concerning non-routine landings to be made by the aircraft;
- e) Messages concerning aircraft parts and materials urgently required;
- f) Messages concerning changes in aircraft operating schedules.

1.6.6 Flight safety messages shall comprise the following:

- a) Movement and control messages (e.g. flight plans, clearances);
- b) Messages originated by an aircraft operating agency, or by an aircraft, of immediate concern to an aircraft in flight;
- c) Meteorological advice of immediate concern to an aircraft in flight or about to depart (individually communicated or for broadcast);
- d) Other messages concerning aircraft in flight or about to depart.

1.6.7 It is permissible for aircraft operating agency messages to be handled by the aerodrome communication facility provided this can be achieved without interference with its primary role and no other channels are available for the handling of such messages.

1.6.8 Public correspondence messages are not permitted on VHF frequencies in the aeronautical mobile service.

1.7 Use of ATS Frequencies for Aircraft Operating Agency Messages

1.7.1 When requested by a company representative, controllers may transmit specific operational messages to aircraft subject to normal air traffic service requirements and shall prefix the transmission "Company advise/request....". When passing such messages the controller must ensure that doing so will not compromise the safe provision of an air traffic service and such messages should not be passed when they could act as a distraction to pilots during critical phrases of flight.

1.7.2 Where messages of a technical and complicated nature are involved it may be found advisable to permit direct speech between the originator of the message and the pilot. In such cases the company's representative may be permitted to use the RTF himself provided that his identity is announced before the message is passed and that the controller continues to monitor the frequency.

1.7.3 A message affecting the safety of an aircraft in flight, e.g. bomb warning, suspected damage to the aircraft etc., is to be passed to the commander immediately using the company representative's precise wording. An abbreviation or précis could be misunderstood and lead to a wasteful operation or even a dangerous situation.

1.7.4 Prolonged company messages could prevent controllers from providing a safe air traffic service and the use of a discrete frequency for the passing of such messages should be considered.

1.8 8.33 kHz Phraseology

1.8.1 As a solution to severe VHF spectrum congestion, ICAO has split the VHF communications band from 25 kHz to 8.33 kHz channel spacing.

1.8.2 The following phraseology shall only be used when referring to 8.33 kHz channels to request the capability of the radio equipment:

 BIGJET 347, confirm eight point three three

 BIGJET 347, affirm eight point three three

or

 BIGJET 347, negative eight point three three

1.8.3 To request UHF capability:

 BIGJET 347, confirm UHF

 BIGJET 347, affirm UHF

or



BIGJET 347, negative UHF

1.8.4 To request the status regarding exemption:

BIGJET 347, confirm eight point
three three exemptedBIGJET 347, affirm eight point three
three exempted

or

BIGJET 347, negative eight point
three three exempted

1.8.5 To indicate that a certain clearance is given because otherwise a non-equipped aircraft would enter the airspace of mandatory carriage.

BIGJET 347, (Clearance/Instruction)
Due eight point three three
requirement

1.9 Operations by aircraft deploying brake chutes

1.9.1 Some military and ex-military aircraft may use brake chutes to slow the aircraft on landing; this procedure is known as streaming. When the pilot deploys the equipment, a small parachute should inflate and trail from the back of the aircraft, thereby slowing its landing run. When the aircraft has slowed sufficiently and is under control, the pilot will jettison the brake chute to detach it from the aircraft.

1.9.2 It is important that pilots who intend to deploy a brake chute advise the aerodrome staff so that appropriate ground procedures can be put in place in order to reduce the flight safety hazard posed to other aerodrome users. Additionally, in certain circumstances, a brake chute may fail to deploy correctly and it is important that, where possible, the pilot is advised of the failure.

1.9.3 Operations by military and ex-military aircraft that use brake chutes commonly take place at aerodromes with FISO or AGCS. The following examples show the phraseology suitable for use by personnel providing FISO, AGCS or aerodrome control.

1.9.4 When the aircraft is downwind or on final to land, the pilot should advise the ATSU if he intends to deploy the brake chute using the word 'stream' or 'streaming' to indicate that the chute will be deployed:

Wrayton Information, Redship 1,
downwind to land and streamRedship 1, Wrayton Information,
Roger, report final

1.9.5 If there is any doubt about the pilot's intentions, the ATSU should ascertain whether or not the pilot intends to deploy a brake chute:

Redship 1, Wrayton, confirm
streaming

Affirm streaming, Redship 1

- 1.9.6 To ensure that other pilots using the aerodrome are aware of the intention to stream, an all-stations broadcast may be made as follows:

	All Stations, Wrayton Information, aircraft on final will be deploying a brake chute
---	--

- 1.9.7 On landing, it is important that, where possible, the pilot is kept informed if the chute does not deploy in the correct manner. The following phraseology may be used according to the situation:

"Callsign streamed and candled" To be used when the chute is seen to deploy but fails to inflate.

"Callsign negative stream" To be used when the chute fails to deploy.

NOTE: Pilots must be aware the ATS will not always be able to advise the malfunction of a chute and that the pilot remains responsible for the safety of the aircraft.

- 1.9.8 Unless otherwise instructed, or where there is a designated area for jettisoning the chute, the pilot should jettison the chute at a suitable location, taking account of the wind speed and direction, preferably when the aircraft has vacated the runway. The term 'drop' or 'dropping' should be used in communications relating to jettisoning the chute as shown in the examples below:

	Wrayton Information, dropping the chute now, Redship 1
---	---

	Redship 1, Roger
---	------------------

or

	Redship 1, Wrayton Information, vacate via link Charlie and drop the chute after passing holding point C3
---	---

	Vacate via link C and drop the chute after passing holding point C3, Redship 1
---	--

1.10 Mareva Injunctions

- 1.10.1 A Mareva injunction (variously known as a freezing order, Mareva order or Mareva regime) is a court order, which prevents a defendant from removing assets from the UK and thus the jurisdiction of the court.
- 1.10.2 Where an aircraft subject to a Mareva injunction is being provided with an air traffic service, controllers/FISOs should inform the pilot that the aircraft is prohibited from leaving the UK, and request the pilot's intentions. The transmission is to be made irrespective of whether the aircraft is conducting an internal UK or an international flight.

	BIGJET 347, you are subject to a Court Order prohibiting your aircraft from leaving the United Kingdom, request your intentions
---	--

1.11 CPDLC Failure

- 1.11.1 In the event of a CPDLC failure, the controller will advise pilots and issue instructions as necessary.

 All stations, Metro Ground, CPDLC failure, standby for Metro Delivery 118.950

1.12 Aerodrome Emergency Services

- 1.12.1 Changes in the level of rescue and firefighting service (RFFS) protection normally available at an aerodrome will be notified by the Aerodrome Operator to the appropriate ATSU to enable the necessary information to be provided to arriving and departing aircraft.
- 1.12.2 ATS units shall ensure that flight crew are notified of unplanned reductions in the RFFS category, as advised by the Aerodrome Operator, either via ATIS or directly by RTF. On receipt of such information, flight crew will decide whether to continue their flight or to divert. Normal ATS and clearances will be provided in response to flight crew intentions.

 G-ABCD, Message from the Aerodrome Operator, rescue and fire facilities reduced to category (number)

 G-ABCD, Message from the Aerodrome Operator, no rescue and fire facilities available

INTENTIONALLY LEFT BLANK

Chapter 10 Military Specific Phraseology

1 Military Specific Phraseology

- 1.1 This Chapter details Military Specific Phraseology for specific use by military ATCOs and military aircrew. The RTF described in this Chapter is complementary to NATO STANAG 3817. It is also complementary to the remainder of CAP 413, as it either differs from civil phraseology or there is no equivalent civil phraseology, e.g. in the case of arrestor system procedures.
- 1.2 Civil pilots visiting military aerodromes will be expected to be aware of the military phraseology in Chapter 10 and to comply with such instructions as may be issued by military controllers during their visit. Where relevant, cross references from the remainder of CAP 413 to the equivalent military phraseology are provided for the assistance of civil pilots visiting military aerodromes.

2 Military Variances to Chapter 2

2.1 Transmission of UHF Channels

Supplementary to guidance detailed in Chapter 2, paragraph 1.4.4, UHF channels are separated by 25 kHz and are to be passed using only the first 5 figures as follows:

Table 1

Frequency	Transmitted as	Pronounced as
332.000	Three three two decimal zero zero	TREE TREE TOO DAY-SEE-MAL ZE-RO ZE-RO
332.025	Three three two decimal zero two	TREE TREE TOO DAY-SEE-MAL ZE-RO TOO
332.050	Three three two decimal zero five	TREE TREE TOO DAY-SEE-MAL ZE-RO FIFE
332.075	Three three two decimal zero seven	TREE TREE TOO DAY-SEE-MAL ZE-RO SEVEN

2.2 Transmission of Time

Supplementary to guidance detailed in Chapter 2, paragraph 1.5, when aircraft check the time with the appropriate Military ATS unit, the time checks shall be given to the nearest half-minute, or to the second on request.

2.3 Standard Words and Phrases

Supplementary to guidance detailed in Chapter 2, paragraph 1.6, the following additional or amended standard words and phrases shall be used.

Table 2

Continue with	Used either when it is known that an aircraft has already established contact with another unit or when pre-notification of details has been passed to the receiving controller but no radar handover has taken place.
Contact	Used when a radar handover has taken place between ATSUs.
Spell	Spell portion indicated phonetically.

2.4 Communications

Units utilising Automatic Terminal Information Service (ATIS) may accept the information coded letter, as transmitted by the pilot, as acknowledgement that the information contained in that code has been received and understood. ATC units employing ATIS codes are to implement procedures to ensure that information transmitted on ATIS is correct and cross-checked for accuracy by an ATCO.

2.5 RT Phraseology When Using SSR

In addition to the phraseology shown in Chapter 5, paragraph 1.3.1, Table 2, military controllers are to use the following RT phraseology when using instructions for the use of SSR transponders: ... (Callsign) (plus following phrase as appropriate):

Table 3

CONTROL TO AIRCRAFT	MEANING
Squawk emergency or Squawk 7700 (see Note)	Select 'EMERGENCY'.

NOTE: Squawk MAYDAY is specified by some nations. See Chapter 5 paragraph 1.3.1 for civil usage. RT Failure and Hijack squawks are to be specified by code, e.g. squawk 7600 and squawk 7500 respectively.

3 Military Specific Procedures (Control of Aircraft)

3.1 NATO Standard Visual Circuit Procedures

Information on NATO standard visual circuit procedures is contained in STANAG 3297. For the convenience of civil pilots landing at military aerodromes, basic information on the military visual circuit is also included in Chapter 11 paragraph 1.4.

3.2 NATO Studs and Common VHF Frequencies

3.2.1 Pilots may request the use of NATO studs rather than the discrete frequencies when making approaches to, or flying in the vicinity of, NATO airfields. The table below lists the first 5 NATO UHF studs; these are to be displayed at controller positions to enable stud numbers to be equated to frequencies when requested by aircrew. Two NATO common VHF channels are also allocated for use by ATC agencies: 122.1 MHz for Tower and 123.3 MHz for Talkdown.

3.2.2 Designation of NATO Studs

Table 4

NATO Stud	Frequency (MHz)	Designation
1	317.5	NATO Common Navigational/Fixer/Guard
2	257.8	Common Tower
3	385.4	Common GCA/Talkdown/Final Control
4	344.0	Common GCA/Marshall/Search
5	362.3	Common Approach Control
Guard	243.0	Common Emergency Frequency

Given the common nature of these NATO UHF and VHF frequencies, pilots and controllers should listen to the frequency before transmitting in order to avoid interfering with transmissions from other units or aircraft.

3.3 **Weather and Aerodrome Information**

- 3.3.1 At aerodromes where ATIS is installed, all weather and aerodrome information transmissions are to be prefixed with a letter code. The letter code is to start with the letter of the alphabet coincident with the first weather issued for the day. Each subsequent weather issued is to be assigned the next letter of the alphabet including 'Met Specials'. The letters I, O, Q and Z are not to be used. If all letters are used in the course of a day/night, then the alphabet is to be started again from the beginning. Pilots are to quote letter of weather and aerodrome information received on initial contact with each appropriate ATC element. Additionally, before taxiing or joining a visual circuit, the pilot is to confirm the runway information he has received. Where ATIS procedures do not apply, weather and aerodrome information may be passed to aircraft either in full or abbreviated. Abbreviated information is only to be passed if colour code is better than green. Training units may require the addition of flying phase information.
- 3.3.2 The long weather and aerodrome information is to be passed in the following order and format:
- Aerodrome/letter code.
 - Time.
 - Runway in use.
 - Surface wind.
 - Colour state.
 - Visibility.
 - General weather observations (when applicable e.g. fog, rain).
 - Cloud levels and amounts.
 - Temperature.
 - Altimeter setting.
 - Runway condition reading (RCR)/runway visual range (RVR) (if applicable).
 - Unserviceable aids/facilities (as appropriate).
- 3.3.3 The short weather and aerodrome information is to be passed in the following order and format:
- Aerodrome/letter code.
 - Time.
 - Runway in use.
 - Surface wind.
 - Colour state.
 - Altimeter setting.
 - Unserviceable aids/facilities (as appropriate).
- 3.3.4 Some emergency, civil or non-British military aircraft may wish to fly in accordance with different pressure setting procedures. If a pilot requests the use of QNH during the final approach the controller may omit QFE and substitute QNH and elevation in appropriate messages.



3.4 Cancellation of Take-Off

At variance to Chapter 4 paragraph 1.7.13, if the aerodrome controller is aware of a potential hazard to an aircraft about to start its take-off run, the controller is to instruct or signal the aircraft to hold. If the aircraft has already started its take-off run, the controller is to inform the aircraft of the hazard; it is then the captain's responsibility to decide the best course of action as it may be more dangerous to abort than to proceed.

3.5 Phraseology for Joining the Visual Circuit/Pattern

The terms circuit and pattern are interchangeable. A join through the Initial Point is an alternative to other ICAO joining procedures for the visual circuit/pattern. It may include a break (pitch) from a point on the deadside in order to make a continuous circle onto final approach or to conduct a standard circuit turn on to downwind leg. This could be determined by aircraft type and/or other circuit traffic with which the joining aircraft has to integrate. There may also be occasions where ATC issues additional positioning instructions to aid sequencing with other traffic. The visual circuit pattern direction shall be left-handed unless otherwise stated. For a diagram of a military visual circuit see Chapter 11 paragraph 1.4.



When ideally 3 to 5 mins from the aerodrome or initial point:

 Markston Tower, VYT 21, 10 miles east, request initial for runway 05, information Bravo	 VYT 21, Markston Tower, join, 2 in
 Join, V 21	

If no current ATIS code is passed, the controller shall supply relevant information.



 Markston Tower, VYT 21, 10 miles east, request initial for runway 05	 VYT 21, Markston Tower, join runway 05, QFE 1015, 2 in
 Join runway 05, QFE 1015, V 21	



At initial point:



 V 21, initial [for the break]	 V 21, one upwind, one downwind
---	--

The examples for joining the visual patterns are not exhaustive and it should be noted that once inside the initial point, local sequencing procedures may be applied. Where these are being used the procedures and detailed phraseology will be included in local orders.

On the Break:

 V 21, on the break to land	 V 21, one ahead, surface wind, 320 5
--	--



 V 21, on the break to touch and go	 V 21, one ahead, surface wind, 320 5 knots
--	---

 V 21, on the break to low approach	 V 21, one ahead, surface wind, 320 5 knots
--	---



'On the break' is equivalent to a downwind call.

3.6 Landing Gear Position

Pilots of aircraft with retractable landing gear shall report the gear position as part of the request for an ATC clearance to use a runway. If the position of the landing gear is not passed at the appropriate point or is required to be checked by the controller then a simple request will be issued.

 Final, gear down	 V 21, cleared to land
--	---

Where a check of the landing gear is required, the following phraseology is used:

 V 21, final	 V 21, check gear down
--	--

 V 21, gear down

 V 21, cleared to land

3.7 Arrestor System Procedures and Phraseology

All landing and take-off clearances are to include advice on the status of the arresting system. The status can be as follows:

Cables:

UP - the cable is raised on rubber rings often referred to as grommets or doughnuts, or on automated raising systems. In this position the cable is ready for engagement.

DOWN - the cable is lowered and normally lying flat on the runway or in a slight recess. The cable cannot be engaged in this position.

DERIGGED - the cable has been physically removed from the runway and will take an extended period of time before it could be ready for an engagement.

'Approach Cable' refers to an arrestor cable in the first half of the runway, normally a short distance beyond the threshold in the direction of landing.

'Centre Cable' refers to an arrestor cable that is positioned approximately at the mid-point of the runway.

'Overrun Cable' refers to an arrestor cable that is in the latter half of the runway in the direction of landing, normally prior to the upwind threshold.

Barrier:

UP – the barrier is in the raised position and ready for an engagement.

DOWN – the barrier is in the lowered position, but could be raised on request.

UNSERVICEABLE – the barrier system is not available.

The position of a cable, in distance from the approach end threshold rounded to nearest 100 ft is to be given to aircraft unfamiliar with the aerodrome. When barrier position and/or cable state is as published in FLIPs, reference to them is normally omitted to aircraft based at the aerodrome and reference to cable state is normally omitted to visiting aircrew that are familiar with the aerodrome. A pilot may require a change to arrestor system positions and will normally try to warn of an imminent engagement.

An airborne aircraft requesting an engagement will provide as much of the following information as possible:

- Callsign and type of aircraft.
- Nature of emergency and which arresting system he is intending to engage.
- Estimated time to landing in minutes.

In addition, except for short or no notice engagements, the pilot should report "Hook Down" as part of the final call. If the controller does not receive the hook down call, a check will be requested:

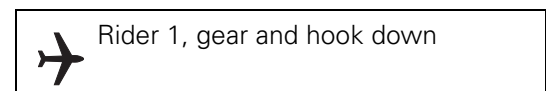
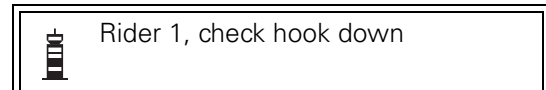
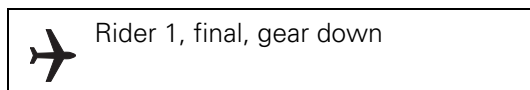

On receipt of a request from an airborne aircraft, the controller is to:

- advise the pilot of the serviceability state of the preferred arresting system;
- if necessary, advise of the time that the arresting system will become available;
- request fuel remaining, and once the engagement has occurred, obtain the aircraft weight and engagement speed;
- pass normal landing information;
- alert the Crash/Rescue Crew to an appropriate readiness state.

After a successful engagement, the pilot will not taxi the aircraft until the ground/recovery party has signalled the aircraft can commence taxi and a clearance to do so has been obtained from ATC.

Following an engagement, the runway shall be declared "black" until the team leader of the recovery crew ensures that the runway has been vacated. The following conditions are to be satisfied prior to informing ATC:

- No personnel, equipments or vehicles are within the confines of the runway or requiring to cross the runway to vacate the area.
- The arresting system has been returned to a serviceable state, a battery position, removed from the runway or declared as unserviceable.

The ATC Supervisor will then declare the runway open.

 Rider 1, final, gear down

 Rider 1, cleared to land, approach cable down, overrun cable up, barrier up

 Cleared to land, Rider 1

The following phraseology will normally be used by pilots to indicate an intent to utilise an arrestor system at short notice:

 Rider 1, barrier, barrier, barrier

 Rider 1, barrier up

 Rider 1, cable, cable, cable

 Rider 1, overrun cable up

ATC will alert the Crash/Rescue crews.

Requests for information on arrestor systems and/or to change the status of an arrestor system:

 Rider 1, request barrier state

 Rider 1, barrier down

 Rider 1, request raise the barrier

 Rider 1, barrier up

3.8 **Phraseology for Fixed-Wing VTOL Operations**

The following terms are used for VTOL operations:

Table 5

Conventional Landing	A practice, or actual aircraft systems emergency landing, when nozzles are used for braking and the aircraft will roll for approximately 5000 ft. In the event of immovable nozzles, a conventional landing may require the whole runway and engagement of the barrier.
Slow Landing	A normal landing (120 knots) at an intermediate nozzle (normally 65°) and involving a considerable ground roll which is arrested by power nozzle braking.
RVL	Rolling vertical landing. A steeper, slower approach (50 knots) followed by an abbreviated ground roll and, normally, no power nozzle braking.
Accel	A rapid throttle opening to ensure engine response correct. Always carried out before take-off but only declared if significant ground roll is required.
Translate	A phrase used to cover largely jetborne flight over short distances between different landing areas.
Press-up	Vertical take-off and landing on the same pad without transition to wingborne flight.
Mini circuit	In flight jetborne manoeuvring associated with a press-up.
Lift-off	Vertical take-off from a pad followed by transition to wingborne flight.
STO hop	A short take-off followed by a rolling vertical landing in the same direction.
Into wind decel	A deceleration into wind prior to a vertical landing.
Pad	An area of concrete for vertical take-off and landing, the surface of which can withstand nozzle blast.
Mexe	A metal pad constructed of prefabricated interlocking aluminium strips in the shape of a circle or square, the surface of which can withstand nozzle blast.

Pilots of VTOL aircraft should be aware that the terms above may not be in regular use at aerodromes that do not operate VTOL aircraft. Therefore, pilots should anticipate that the terms may not be understood by ATC. In such circumstances pilots of VTOL aircraft are to revert to standard NATO procedures and phraseology for standard circuits/patterns.

3.9 **Emergency Messages**

Emergency messages from military pilots differ from civil emergency messages, and are detailed in JSP 552 Section 700.

3.10 **Flameout/Engine Failure – Aerodrome Phraseology**

In a real flameout or engine failure situation the appropriate emergency message will be passed by the aircraft along with the statement of intent for a flameout recovery. The phraseology to be used when radar is available to the controller is detailed at paragraph 3.27.

Once visual with the aerodrome the pilot will position for High Key:

 Raider 21, High Key (intentions)

 Raider 21, one ahead, surface wind 230 10 knots

On some occasions the aircraft may be forced to position straight to Low Key in which case the High Key call will be missed.

 Raider 21, Low Key

 Raider 21

If a PFL/Flameout/Engine Failure call is made direct to an Aerodrome Controller who is not equipped with radar, then a heading will not be given, the aircraft shall be instructed to join, passed aerodrome information if required and told to report High Key from where the phraseology above shall be used.

3.11 **PAR Phraseology****Whilst positioning for the approach:**

 Gauntlet 25, vectoring for PAR runway 23, procedure minimum (number) feet

 Gauntlet 25, (number) feet, touch and go for further

Initial contact to Talkdown controller:

 Markston, talkdown, Gauntlet 25

 Gauntlet 25, identified 8 miles, read back QFE

 1015 set, Gauntlet 25

 Do not acknowledge further instructions unless requested



Glidepath information during the approach:

 Approaching descent point

 Begin descent now for a (number) degree glidepath*

 Slightly above/below glidepath

 Well above/below glidepath

 Dangerously below glidepath, acknowledge	 Roger, Gauntlet 25
--	--

* The instruction "Do not acknowledge further instructions unless requested" can be added to this instruction if it has not previously been passed.

Reporting of aircraft position in relation to the extended runway centreline, which may follow a turn instruction if appropriate or can be used in isolation:

 Left of centreline, correcting rapidly
--

 Slightly right of centreline, correcting slowly

 Right of centreline



 On centreline



General position information:

 (Number) miles [from touchdown]

 (Callsign), over touchdown
--

A gear check or pre-landing checks verification (depending on gear type) should be conducted at an appropriate point on the approach, prior to obtaining a clearance from the Aerodrome controller, which should then be acknowledged by the pilot:

 (Number) miles, check gear acknowledge	 Gear down, Gauntlet 25
--	--

 (Number) miles, confirm checks complete	 Checks complete, Cessna 52
---	--

Final stages of the approach:

 Approaching decision height

 Passing decision height

 Gauntlet 25, over touchdown

 Gauntlet 25, changing to
(appropriate stud or frequency)

3.12 PAR Azimuth Only/SRA Phraseology

When PAR is not available, the surveillance radar may be used to carry out a non-precision Surveillance Radar Approach (SRA). Using this procedure, or when practicing for it (PAR Azimuth Only), the controller passes instructions and information to the pilot to enable him to follow a pre-determined approach path to a position from which a visual landing or circuit can be made.

Whilst positioning for the approach:

 Gauntlet 25, PAR Az Only/SRA
runway 23, procedure minimum
(number) feet

 Gauntlet 25, (number) feet, touch
and go for further

Initial contact to Talkdown controller:

 Markston, talkdown, Gauntlet 25

 Gauntlet 25, identified 8 miles, read
back QFE

 1015 set, Gauntlet 25

 Do not acknowledge further
instructions unless requested

Glidepath information during the approach:

 Left of centreline, correcting rapidly

 Slightly right of centreline,
correcting slowly

 Right of centreline

 On centreline

 Approaching descent point

 Begin descent now for a (number)
degree glidepath*

 (number) miles, (number) feet**

* The instruction "Do not acknowledge further instructions unless requested" can be added to this instruction if it has not previously been passed.

** Advisory information to be given at ½ NM intervals. (RN pass ranges at ½NM intervals and heights at 1/3 NM intervals).

Reporting of aircraft position in relation to the extended runway centreline, which may follow a turn instruction if appropriate or can be used in isolation:

General position information:

 (Number) miles [from touchdown]

 Gauntlet 25, over touchdown

A gear check or pre-landing checks verification (depending on gear type) should be conducted at an appropriate point on the approach, prior to obtaining a clearance from the Aerodrome controller, which should be acknowledged by the pilot:

 (Number) miles, (number) feet, check gear, acknowledge



Gear down, Gauntlet 25

 (Number) miles, (number) feet, confirm checks complete



Checks complete, Cessna 52

Final stages of the approach:

 Approaching Minimum Descent height

 Approaching Missed Approach Point

 Passing Missed Approach Point

* When the Minimum Descent Height is within ½ NM of the Missed Approach Point, the phrase 'Approaching Minimum Descent Height' is not included.

3.13 ILS Phraseology

Whilst positioning for the approach

 Gauntlet 25, 2000 feet wind (number)



Gauntlet 25 , vectoring for ILS
runway 23, procedure minimum
(number) feet



Gauntlet 25, (number) feet, touch
and go for further



Gauntlet 25, report Localiser
established, checks complete



Gauntlet 25, Localiser established,
checks complete

Initial contact with Talkdown controller:



Markston, talkdown, Gauntlet 25



Gauntlet 25, identified 8 miles, read
back QFE



1015 set, Gauntlet 25



Gauntlet 25, report glidepath
descending gear down



Glidepath descending gear down,
Gauntlet 25

Final stages of the approach:



Approaching Decision Height*



Passing Decision Height*



Approaching Minimum Descent
Height**



Approaching Missed Approach
Point**



Passing Missed Approach Point**

* Full ILS.

** ILS Localiser Only – (When the Minimum Descent Height is within ½ NM of the Missed Approach Point, the phrase 'Approaching Minimum Descent Height' is not included.

3.14 Descent to Low Level

When a pilot requires descent below a controller's terrain safe level, the controller should remind him of terrain responsibility as part of the approval for further descent.

 Tiger 2, request descent to low-level

 Tiger 2, taking your own terrain clearance, descent approved.

 Tiger 2, my own terrain clearance, descent approved.

Controllers should also consider informing the pilot of reduced traffic information if the additional descent has surveillance coverage implications.

3.15 Jamming phraseology

When an ATS unit is suffering from the effects of jamming or interference on a frequency or a radar, the phrases below may be used to request the jamming or interference to be stopped. If the callsign causing the jamming is not known then the phrase "All Stations" can be used or the phrase 'Hooter' can be used on the emergency frequency 243.0 MHz.

 Rider 21, cease jamming

 Rider 21, jamming ceased [at time (number)]

3.16 Speechless Procedures

If an aircraft loses the ability to transmit speech, pilots should adopt the speechless procedure and all controllers should be familiar with this phraseology.

Before a recovery is effected, certain information common to all types of speechless emergencies is to be ascertained using the speechless code. The ● symbol denotes short carrier-wave only transmissions and a long-dash indicates a long transmission. The code uses these transmissions as follows:

- = Yes
- = No
- = Say Again
- = Homing/Request Assistance
- = Further Emergency

In addition pilots will use one long transmission to indicate the requested manoeuvre or action has been completed. Controllers should be aware that giving more than one instruction at once may require subsequent yes/no type questioning to ascertain which instruction has been completed.

 ●●●●

 Speechless aircraft, Markston Approach, do you require recovery to Markston?

If the aircraft answers no (●●) then the controller should try to ascertain the pilot's intentions using a questioning technique that allows yes/no answers and render what assistance he can.

If the aircraft answers yes (●):

	Speechless aircraft, adopt the callsign Speechless 1*, is this a practice?
---	--

* Whilst it is unlikely the controller will be working more than one speechless aircraft at a time, it is possible. The controller should allocate numbers in sequence with the first aircraft being allocated Speechless 1 as the callsign.

Depending on the answer the controller is to then ascertain if there are any other forms of emergency:

	Speechless 1, do you have any other form of [practice] emergency?
---	---

If the aircraft indicates a further emergency then the questions in the table below should be asked in sequence moving to the appropriate column for aircraft type (once ascertained if required) if the answer to one of the main questions is no. These questions are not intended to provide an answer to all possible emergencies and controllers must be prepared to adapt to any given situation.

Table 6

Main Question	Supplementary Questions	
	Fixed Wing	Rotary Wing
Can you maintain height?	Are you flamed out? Are you short of oxygen? Are you affected by icing?	Do you have a control problem? Do you have an engine failure? Are you affected by icing?
Can you carry out a normal recovery?	Are you short of fuel? Are you asymmetric? Do you have an instrument failure? Do you have electrical failure? (see note) Do you have hydraulic failure? (see note)	Are you short of fuel? Do you have single engine failure? Do you have an instrument failure? Do you have electrical failure? Do you have hydraulic failure?
Can you carry out a normal landing?	Do you have an undercarriage problem? Do you have a brake failure? Do you intend to engage the cable? Do you require the barrier?	Do you have an undercarriage problem? Can you hover? Do you require a running landing?

NOTE: If it is established that the aircraft type is a Tornado, then controllers should ask if the aircraft has a wing sweep failure.

From this point, the controller should ascertain the type of recovery required, identify the aircraft and provide positioning instructions for the requested recovery procedure. It may also be necessary to ascertain whether there are any casualties on board. If the list becomes exhausted without ascertaining the emergency then the controller may use additional questions to understand the problem but not to the detriment of providing appropriate control to recover the aircraft expeditiously. Furthermore, if the pilot indicates the aircraft has suffered a further emergency at any point beyond either the speechless emergency or any other identified through questioning, then the controllers should start the questioning process again, time and circumstances permitting.

A pilot, when calling for either an actual or practice speechless recovery, may already be receiving a radar service from the controller, which may assist identification:

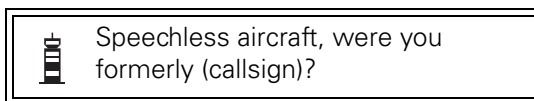

On transfer between controllers it is important for the receiving controller to confirm that the speechless aircraft calling him is the same one that has been transferred to him from the other controller. **The pilot will initiate contact with the receiving controller using the Homing/Request Assistance call:**

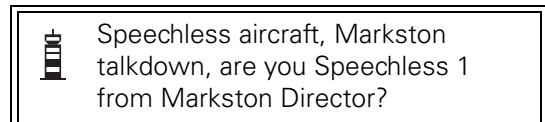

A gear check for a Speechless aircraft must be a direct question:

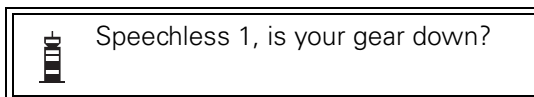

3.17 Military Missed Approach



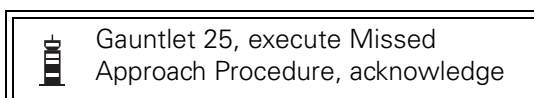



At variance to Chapter 4 Paragraph 1.10.1, an ATCO instructing an aircraft carrying out an instrument approach at a military unit to carry out a Missed Approach Procedure will use the following phraseology:



Within the visual circuit, the phraseology defined within Chapter 4 Paragraph 1.10.1 is to be used. On being instructed to go around, the aircraft is to break off the approach and climb to circuit height, normally on the deadside (or as briefed, if different, at specific aerodromes).

3.18 Suspension of RT Procedures



Aircraft may require to operate in a specified area or on an area of an aerodrome without making RTF transmissions that would normally be required. **The request to suspend such transmissions is referred to as operating 'negative RT' and the associated phraseology is as follows:**

 Rotor 99, request operate for (number) minutes no RT southside	 Rotor 99, negative RT approved, for (number) minutes, remaining southside
 Rotor 99, request Ops normal*	 Rotor 99, Ops normal
 Rotor 99, operate full RT	 Operating full RT, Rotor 99

* The time between Ops Normal calls will be covered in local flying orders.

3.19 Formations in Trail

The request for conducting a trail approach shall be made as follows:

 (Callsign), request trails approach [(number) aircraft or elements]	 (Callsign), trails approach approved
--	---

3.20 Contact Lost

The term "Contact Lost" when used by a pilot refers to a situation where one or more elements of an aircraft formation loses visual or station keeping equipment contact with one or more elements of the formation. In this instance the formation will invoke standard procedures to establish separation between the elements and the controller must be prepared for a request to identify individual formation elements in order to provide a service and potentially pass instructions aimed at allowing the formation to rejoin. Upon losing contact within a formation, pilots may set transponder code to 7700.

3.21 Freecall and Continue With

The term "Freecall" is used by a controller to indicate to the pilot that landline communication to the next controller has not been possible prior to transfer position. The pilot should then be prepared to give full position, heading and level information to the next controller.

 Ranger 22, unable to arrange a handover to Wadford, your position 10 miles east of Smallville, freecall Wadford Approach 345.675	 Freecall Wadford Approach 345.675, Ranger 22
--	--

The term "Continue With" is used by a controller to indicate to the pilot that his flight details and profile have been prenoted to the next controller, but it is not possible to effect a formal radar handover.



Mission 59C, unable to arrange a handover to Wadford, your position 10 miles east of Smallville, continue with Wadford Approach 345.675



Continue with Wadford Approach 345.675, Mission 59C

3.22 Aerobatics and General Handling

The term "Block" can be used to describe a height band that an aircraft requires to operate in. The aircraft will subsequently manoeuvre not below the lowest specified level and not above the highest specified level. Normally, the levels will be specified in terms of flight levels.



C55, request operate in the block 120 to 190



C55, operate in the block Flight Level 120 to Flight Level 190

3.23 Passing the Number of Persons on Board (POB)

The pilot should pass the POB in accordance with local or national orders. If not passed, controllers may need to request POB from the pilot.



C55, request POB



C55, (number) POB

3.24 Clearances with an Occupied Runway

Where approved, in order to maintain an expeditious flow of air traffic, there are occasions where a controller may utilise clearances where the runway in use is still occupied by another aircraft. Whilst the controller is providing these clearances based on a professional assessment of the situation, it is incumbent on the pilot to make the final decision to execute the clearance. These clearances can only be used for preceding aircraft that conducted an approach and are not to be used for vehicles or aircraft crossing the active runway.



(Callsign), cleared to land [(traffic details)*]



Land, [(traffic details)], (callsign)



(Callsign), cleared touch and go, one ahead [(aircraft type**)]







Touch and go with one ahead, (callsign)

* The controller may include the aircraft type if it is considered necessary to aid clarity. Local orders may dictate how much of the approach end of the runway must be available before this clearance can be issued.

** The aircraft ahead must have commenced the acceleration stage of the Touch and Go before this clearance is issued.



3.25 Formation Clearances

Individual elements of a formation may be issued clearances to land before the preceding element has reached the runway. The formation elements are responsible for their own separation on final and are responsible for executing fast and slow lane procedures as covered in their own formation briefings.

 (Callsign) one, final gear down [(intentions)]	 (Callsign) one, cleared to land
 (Callsign) two, final gear down [(intentions)]	 (Callsign) two, cleared to land in turn







3.26 TACAN Specific Phraseology

Initial positioning:

 Markston Approach, VYT 21, 320 Markston at 25 miles heading 170, flight level 110, request TACAN to ILS	 VYT 21, Markston Approach, identified flight level 110, own navigation to the initial approach fix, report steady with heading
--	---

The controller should ascertain whether the pilot requires to conduct any holding at the Initial Approach Fix and ask the pilot to report approaching the fix. Once the pilot makes the report the phraseology will depend on whether holding is required.

Holding required:

 (Callsign), approaching the fix	 (Callsign), report established in the hold
 (Callsign), established in the hold	 (Callsign), report approaching the fix ready for the procedure
 (Callsign), approaching the fix ready for the procedure	 (Callsign), clear TACAN approach, Runway (designator) QFE (number), report leaving flight level (number), [two thousand foot wind (<i>2000ft wind</i>)]

The controller may inform the pilot of the time at which an aircraft will be permitted to continue its flight or when a further clearance will be given.

If holding is not required and an immediate clearance can be issued, then the clearance phrase above can be used on the first report from the pilot. If a clearance for the procedure cannot be issued at any point:

 (Callsign), approaching the fix ready for the procedure	 (Callsign), continue to hold, report approaching the fix
--	---

3.27 Radar PFL

Initial Call:

 Markston Approach, VYT 21,
(position), FL/Altitude (number),
request Radar PFL

In a real flameout situation, the appropriate emergency message will be passed by the aircraft and a Radar Forced Landing undertaken. Identification should be as expeditious as possible, taking into account the limitations of an aircraft suffering this type of emergency.

Homing:

 V 21, set heading (number) degrees

 Heading (number) degrees, V 21

 V 21, identified Traffic Service,
report accelerating*

* Ranges to be passed every 1 NM prior to acceleration, then every ½ NM thereafter.

 V 21, turn left/right (number)
degrees heading (number) degrees,
range

 Left/right heading (number) degrees,
V 21

 Accelerating, V 21

Joining the Visual Circuit:

 V 21, report aerodrome in sight

 Aerodrome in sight, V 21

 V 21, continue with Markston
Tower, stud/freq

3.28 Controlled Descent through Cloud (QGH)

Controlled descent through cloud (QGH) procedures are designed to enable a pilot, with the assistance of a ground-interpreted DF aid, to descend through cloud to a position in the vicinity of an airfield from which he can make a visual approach and landing or be positioned within the operational service coverage of an additional navigation aid for continued recovery. There are two standard controlled-descent procedures, one for jet aircraft requiring descent from high levels and the other for aircraft below FL120.

3.28.1 **High Level QGH****Initial Call:**

 Markston Approach, Gauntlet 25, position (number), FL/Altitude (number), request QGH

Homing:

 Gauntlet 25, Markston Approach, heading for Markston (number) degrees*, fly at FL (number)**

 Steady heading (number) degrees, maintaining FL (number), Gauntlet 25

* QDMs or QTEs should be obtained at intervals as required to home aircraft to the overhead.

** Aircraft are to be homed at quadrantal or semi-circular flight levels unless local orders say otherwise.

Overhead:

 Gauntlet 25, transmit for overhead

 Transmitting for overhead, Gauntlet 25

 Gauntlet 25, indicating overhead, turn left/right heading (number) degrees

Two overhead indications are required (DF) to confirm aircraft overhead.

Outbound:

Descent commences when trace indicates aircraft within 60° either side of ideal outbound QDM or QTE. QDMs or QTEs are checked and corrected as required on outbound leg.

 Gauntlet 25, steady heading (number) degrees

 Gauntlet 25, set QFE (number) millibar

 QFE (number) millibar set, Gauntlet 25

 Gauntlet 25, descend to height (number) feet (IAH), report turning left/right at (number) feet*

* Turning height is normally half the initial approach height.

Turning Inbound:

 Gauntlet 25, turning left/right

 Gauntlet 25, turn left/right heading (number) degrees, report steady, report approaching (number) feet (IAH)

 Gauntlet 25, steady heading (number) degrees, will report approaching (number) feet

Inbound (Final Approach):

QDM checks are obtained until the aircraft is safely within the final approach area. Aircraft to be maintained within the final approach area.

 Gauntlet 25, approaching (number) feet

 Gauntlet 25, continue descent to MDH

or,

 Gauntlet 25, maintain FL (number)

or,

 Gauntlet 25, descend to height (number) feet

 Gauntlet 25, report aerodrome in sight

 Aerodrome in sight, Gauntlet 25

3.28.2 Low Level QGH**Initial Call:**

 Markston Approach, UAS 21, position (number), FL/Altitude (number), request QGH

Except in emergency, if the aircraft is below the minimum safe flight level, safety height or altitude, it is not to be homed. Appropriate instructions are to be given to the pilot to climb to a safe height or altitude.

Homing:

 UAS 21, Markston Approach, set heading (number) degrees, fly at FL/feet (number)*

 Steady heading (number) degrees, maintaining FL/feet (number), UAS 21

* If below Transition Level, RPS to be given.

QDMs or QTEs should be obtained at intervals as required to home aircraft to the overhead.

Overhead:

 U 21, transmit for overhead

 Transmitting for overhead, U 21

 U 21, indicating overhead, turn left/right heading (number) degrees

Two overhead indications are required (DF) to confirm aircraft overhead.

Outbound:

When aircraft is steady outbound, the controller is to start timing the outbound run according to aircraft speed and wind effect.

 U 21, steady heading (number) degrees

 U 21, set QFE (number) millibar

 QFE (number) millibar set, U 21

 U 21, descend to height (number) feet

Inbound Turn:

The inbound turn is to be given at the end of the timed run. Turn should normally be level; however, exceptionally, a turn may be given while in the descent but a minimum of 1000 ft obstacle clearance is to be maintained.

Inbound (Final Approach):

QDM checks are obtained until the aircraft is safely within the final approach area, which should then be maintained.

 U 21, steady heading (number) degrees

 U 21, continue descent to MDH

 U 21, maintain (number) feet, report aerodrome in sight

 U 21, report aerodrome in sight

 U 21, aerodrome in sight







3.29 Flameout Spiral Descent

In a real flameout situation, the appropriate emergency message will be passed by the aircraft with a request for a flameout recovery (FO).

Initial Call:

 Markston Approach, Gauntlet 25, position (number), FL/Altitude (number), request PFO









Homing:







 Gauntlet 25, Markston Approach, set heading (number) degrees, report steady, set QFE (number) mb	 Steady heading (number) degrees, QFE (pressure) mb set, Gauntlet 25
 Gauntlet 25, pass altitude/height with all transmissions	
 (Number) feet, Gauntlet 25	
 Gauntlet 25, the safety height is (number) feet*, report passing 8000 feet and 4000 feet	
 (Number) feet, Gauntlet 25	
 Gauntlet 25, this will be a left/right hand spiral from the overhead**	

* Visiting aircraft are to be advised if significant high ground within 10 NM of the aerodrome.

** Direction of spiral should be as visual circuit in use.





Overhead:

 Gauntlet 25, transmit for overhead	 Transmitting for overhead, (number) feet, Gauntlet 25
 Gauntlet 25, indicating overhead, commence spiral left/right, report cardinal headings with height	
 Commencing spiral left/right, (number) feet, Gauntlet 25	
 Passing N/S/E/W, (number) feet, Gauntlet 25	 Gauntlet 25, continue spiral
or,	
 Gauntlet 25, stop turn heading (number) degrees	
 Gauntlet 25, recommence spiral left/right	 Spiral left/right, (number) feet, Gauntlet 25

	 Passing 8000 feet, Gauntlet 25
	 Passing 4000 feet, Gauntlet 25
 Gauntlet 25, continue spiral, report breaking cloud	 Breaking cloud, Gauntlet 25
 Gauntlet 25, approaching safety altitude/height, aerodrome on your left/right, report visual	 Aerodrome in sight, Gauntlet 25
	 Gauntlet 25, continue with Markston Tower (frequency)

3.30 No Compass/No Gyro

If a controller observes an aircraft that does not appear to be tracking as expected for the heading provided or notified by the pilot, the controller may suspect that the aircraft has suffered a compass and/or gyro failure. Initially, the controller will confirm the heading that the aircraft is following and thereafter may invoke the No Compass/No Gyro procedure.

 (Callsign), confirm heading	 (Callsign), heading (heading)
 (Callsign), suspect unserviceable compass and gyro. Adopt no compass no gyro procedure, make all turns rate one, start and stop turns on the executive word now. [Is this a practice?]	 (Callsign), adopting [no compass or no gyro] procedure, this is [not] a practice

Once the procedure has been adopted turn instructions will be as follows:

 (Callsign), turn [left or right] now	 Turning [left or right], (callsign)
 (Callsign), stop turn now	 Stop turn, (callsign)

3.31 Supersonic Flight

The phrase used to approve the commencement of a supersonic run is as follows:

 Gauntlet 25, cleared to accelerate, report supersonic and subsonic
--

3.32 Military Aerodrome Traffic Zones (MATZ) and Penetration Services

- 3.32.1 Comprehensive details of MATZ and the associated penetration service, including controlling aerodromes, contact frequencies and hours of watch, are contained in the UK AIP ENR Section, AICs, AIP Supplements or System NOTAM.
- 3.32.2 While every effort will be made to ensure safe separation, some civil aircraft flying within the MATZ may not be known to controllers and therefore pilots should keep a careful look-out at all times.
- 3.32.3 Pilots requiring a MATZ, and where appropriate, ATZ penetration service must establish two way RTF communication on the appropriate frequency with the aerodrome controlling the zone when 15 NM or 5 min flying time from the boundary whichever is the sooner, and request approval to penetrate the MATZ, and if appropriate ATZ. When requested by the controller to 'pass your message' the pilot should pass the following information:
- Aircraft Callsign / Type
 - Departure Point and Destination
 - Present Position
 - Level
 - Additional details / Intention (e.g. Flight Rules, Next Route Point)

 Westbury Approach, G-ABCD, request MATZ and ATZ penetration

 G-ABCD, Westbury Approach, pass your message

 G-ABCD, Cessna 172, from Borton to Walden, over Middleton, altitude 2500 feet Wessex 1005, VFR, tracking to Wells

 G-CD, MATZ and ATZ penetration approved, cross MATZ at 1500 ft on Westbury QFE 1001

 MATZ and ATZ penetration approved, cross MATZ at 1500 ft on Westbury QFE 1001, G-CD

 G-CD, report entering and leaving the MATZ

 Wilco, G-CD

- 3.32.4 When it is not possible for the controller to approve a penetration of the ATZ, the controller shall advise the pilot.

 G-CD, MATZ penetration approved, remain outside the ATZ

- 3.32.5 Whilst working a MATZ unit, pilots are expected to comply with any instructions issued by controllers and maintain a listening watch on the allocated RTF frequency. They should not change heading or level without giving prior warning and should advise when leaving the MATZ. At some MATZ units, the Zone controller is responsible for MATZ penetration services.
- 3.32.6 When crossing a CMATZ it is the responsibility of the pilot to ensure that clearance is obtained to transit each individual ATZ embedded therein. The pilot, in his request for clearance to transit the CMATZ, may ask the controller to obtain such clearance(s) on his behalf. When issuing any clearance to cross a CMATZ controllers will, where appropriate, articulate clearly any approval or otherwise to transit embedded ATZs.

 G-CD, request penetration of Westbury MATZ and ATZ and Eastbury ATZ

 G-CD, penetration of Westbury MATZ approved. Remain outside the Westbury and Eastbury ATZ

3.33 **Military Safety Broadcast – Sécurité**

Military ground stations may commence a broadcast message with 'SECURITÉ SECURITÉ SECURITÉ' (SEC-URI-TAY spoken three times) to inform all traffic that the message contains information affecting safety, but not an emergency situation. Aircraft acknowledgement is not required, however aircraft may contact the ground station to obtain further details.

 SECURITÉ SECURITÉ SECURITÉ,
All traffic, Westbury Approach, D527
now active for live firing, surface to
2500 feet

INTENTIONALLY LEFT BLANK

Chapter 11 Phraseology Examples

1 Examples of Types of Flights

1.1 Introduction

An example of an IFR flight from one major airport to another, and an example of a VFR flight from a provincial aerodrome to a landing site, are given in graphic form in this Chapter. The latter then changes to an IFR flight on departure again to illustrate the differences between Deconfliction Service and Traffic Service (see Chapter 6). The agencies are described in Figure 1.

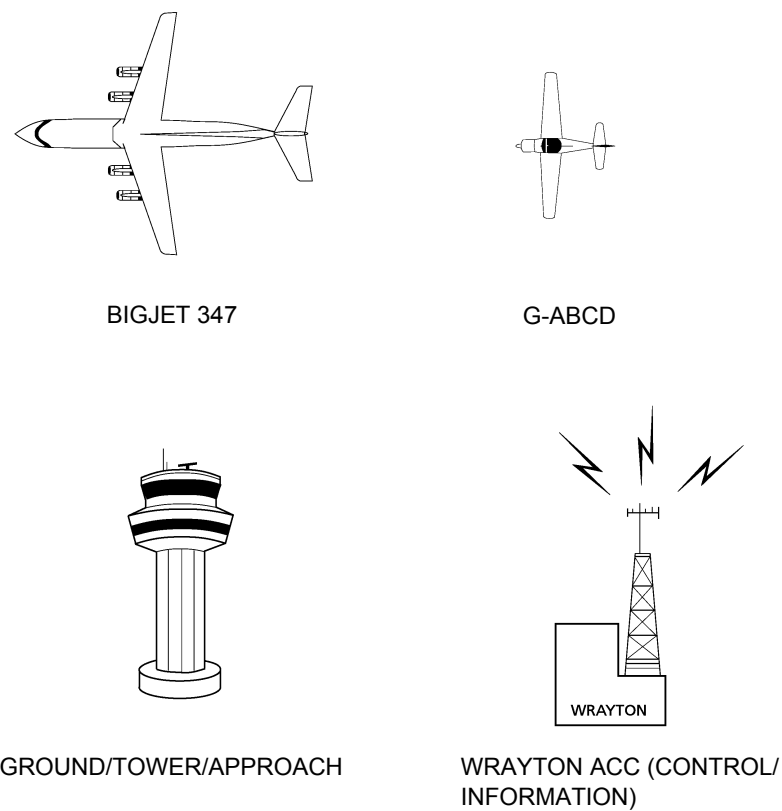

Figure 1 Diagram Key

1.2 An IFR Flight

1.2.1 Start up

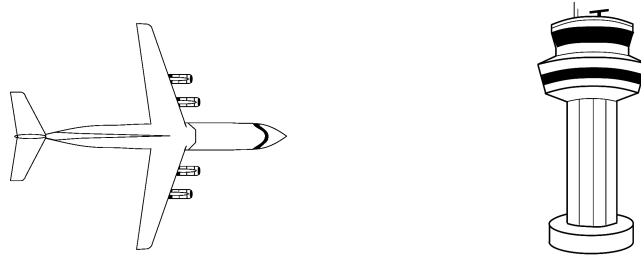
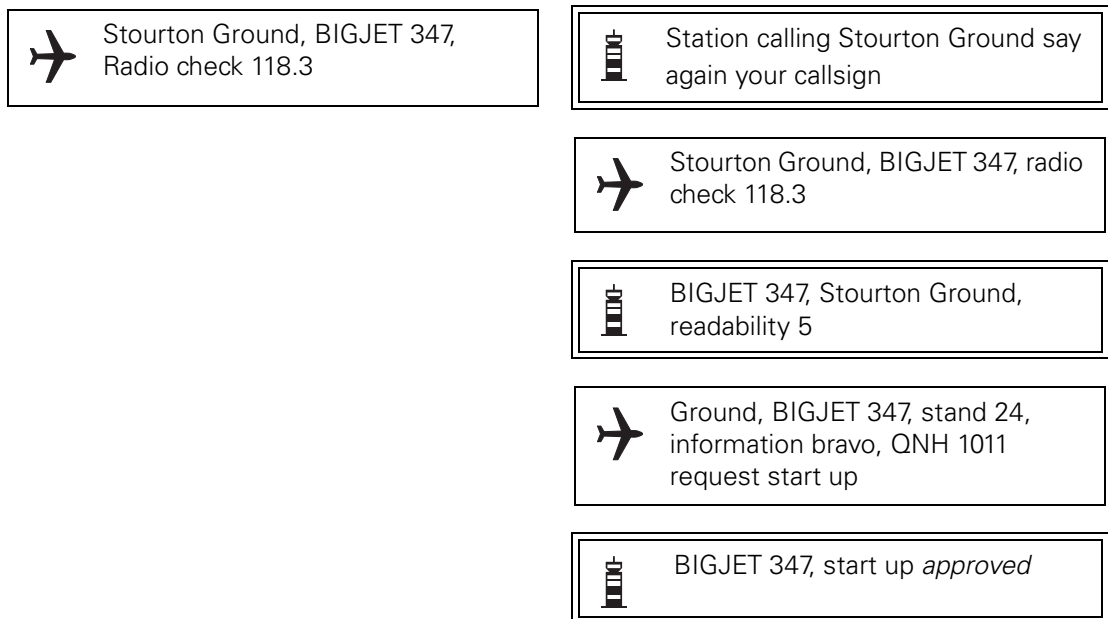

Figure 2 IFR – Start Up Approval



NOTE: The word 'APPROVED' is used - not 'CLEARED'.

1.2.2 ATC Clearance

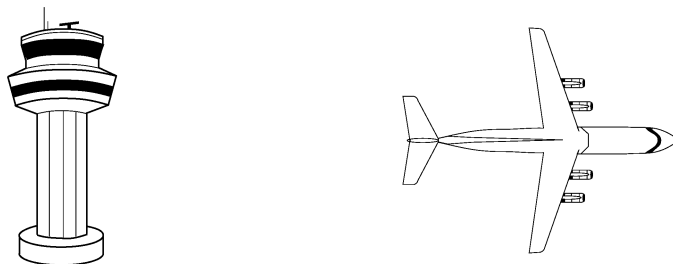

Figure 3 IFR – ATC Clearance



NOTES:

- 1 The word CLEARED is introduced.
- 2 A full readback of a clearance is required.

1.2.3 **Pushback and Taxi**

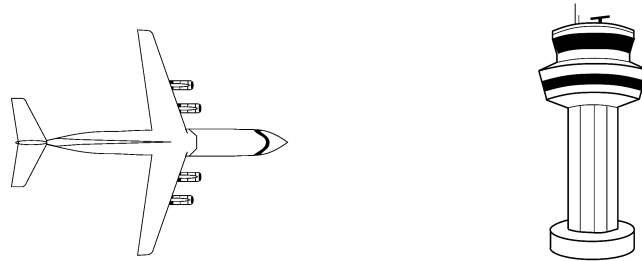

Figure 4 IFR – Pushback Approval

Ground, BIGJET 347, request pushback	BIGJET 347, pushback approved
--------------------------------------	-------------------------------

NOTE: The word 'APPROVED' is used - not 'CLEARED'.

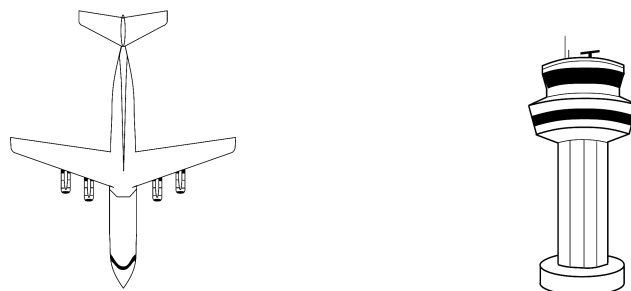

Figure 5 IFR – Taxi Instructions

Ground, BIGJET 347, information Charlie QNH 1011 request taxi	BIGJET 347, taxi holding point G2 runway 24
	Taxi holding point G2 runway 24, BIGJET 347
	BIGJET 347, contact Stourton Tower 118.950
	Stourton Tower 118.950, BIGJET 347

1.2.4 Pre-departure and Take-off

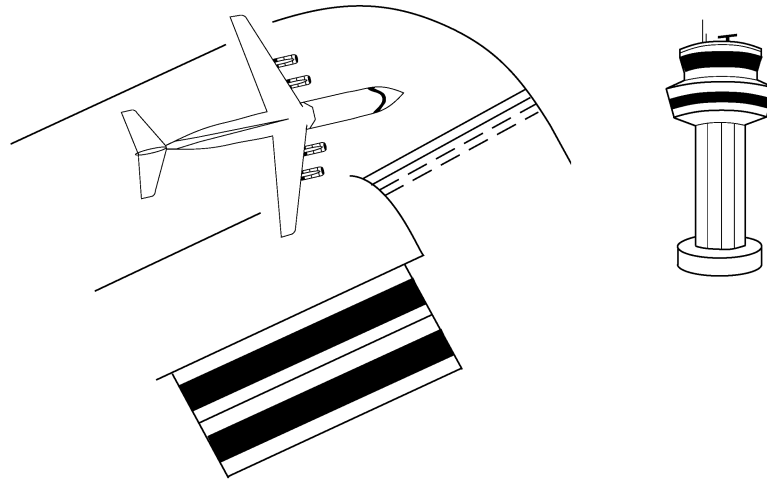
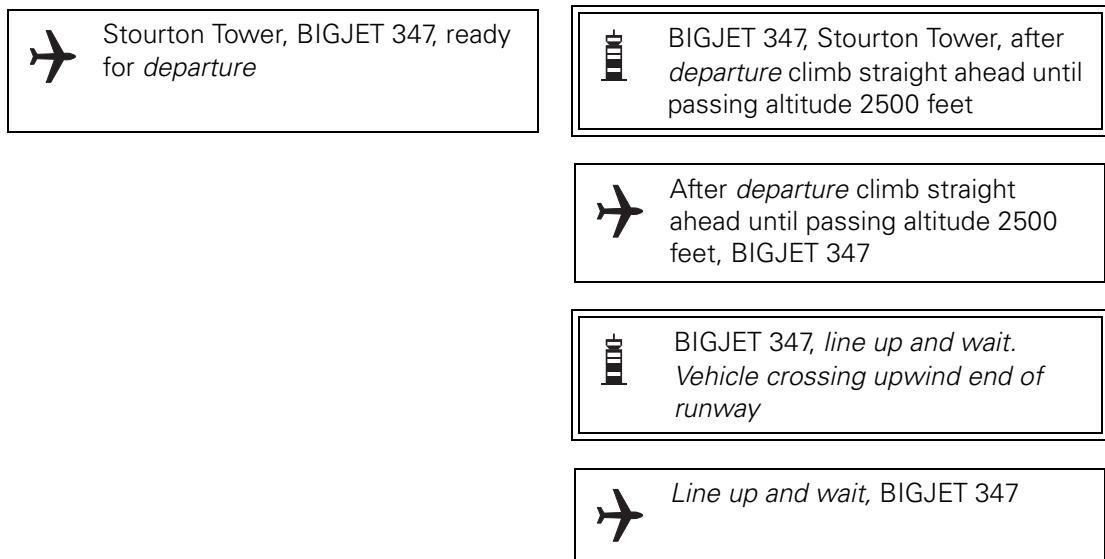

Figure 6 IFR – Departure Instructions and Line-up (i)

**NOTES:**

- 1 'DEPARTURE' employed and not 'TAKE-OFF'.
- 2 'CLEARED' is not used in these cases – see next 'Notes'.
- 3 Full readback is required for instructions to ENTER, LAND, TAKE-OFF ON, BACKTRACK, HOLD SHORT OF, OR CROSS a runway.
- 4 'LINE UP AND WAIT' (plus reason) is employed; 'LINE UP' (only) may also be used.

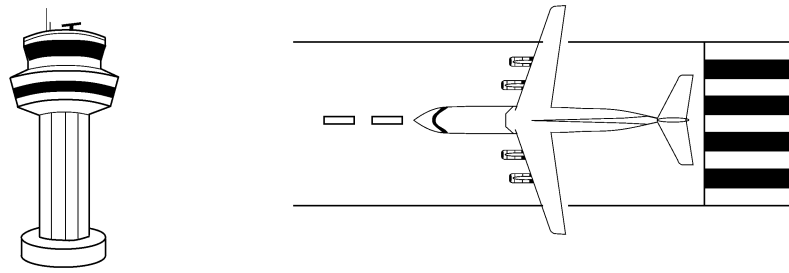



Figure 7 IFR – Take-off Clearance

 BIGJET 347, cleared for take-off
surface wind calm

 Cleared for take-off, BIGJET 347

NOTES:

- 1 TAKE-OFF – these words are *only* used when an aircraft is cleared for TAKE-OFF.
- 2 TAKE-OFF clearance requires readback.
- 3 Use of CLEAR is restricted to:
 - i) ATC clearances.
 - ii) Departure and Approach instructions.
 - iii) Take-off and landing clearances.

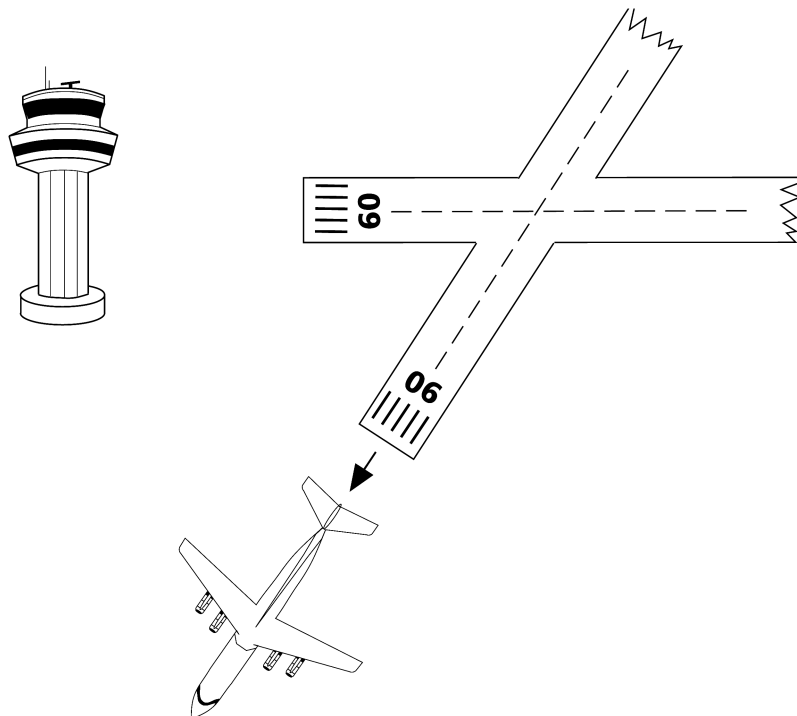



Figure 8 IFR – Airborne Report

 BIGJET 347, contact Wrayton control
129.1

 Wrayton Control 129.1, BIGJET 347

NOTE: Full readback of frequency change.

1.2.5 En-Route

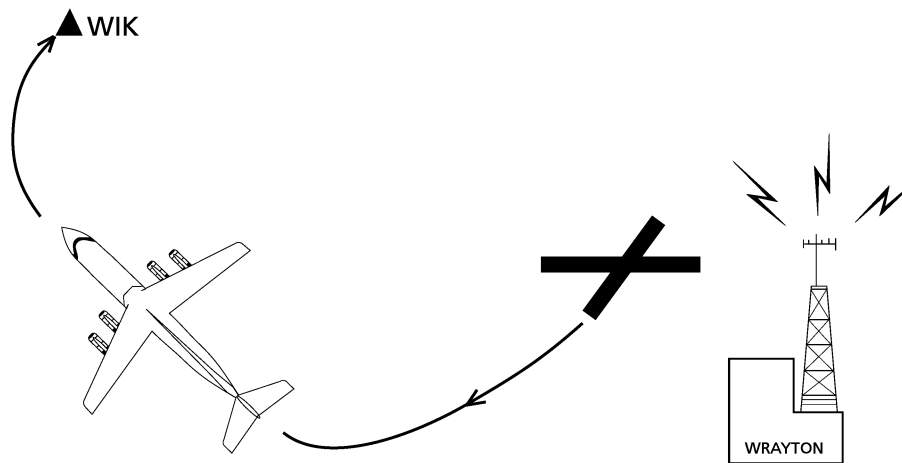





Figure 9 IFR – Departure Report (i)

 Wrayton Control, BIGJET 347,
passing altitude 3000 feet Stourton
QNH 1011 turning inbound Wicken
climbing FL60 requesting FL280

 BIGJET 347, Wrayton Control,
climb FL280 report reaching

 Climbing FL280 Wilco, BIGJET 347

NOTES:

- 1 Full readback of level instruction.
- 2 REPORT instruction employed.

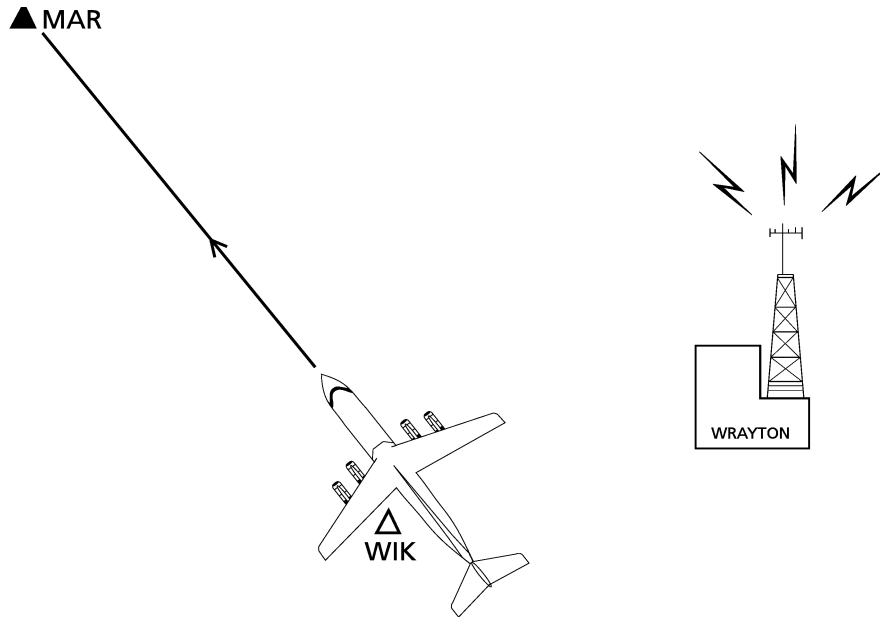



Figure 10 IFR – Position Report

 BIGJET 347, Wicken 47 FL130 climbing FL280 Marlow 07

 BIGJET 347, Roger

NOTE: Position report consists of:

- a) Aircraft identification.
- b) Position.
- c) Time.
- d) Level.
- e) Next position and ETA.

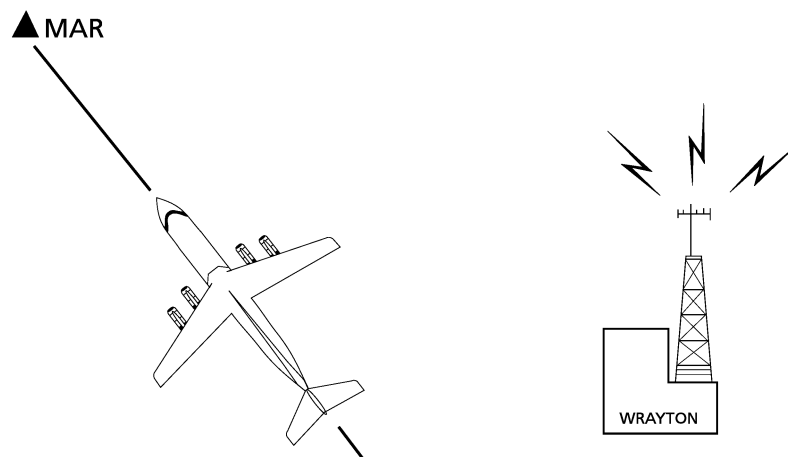



Figure 11 IFR – Level Report

 BIGJET 347, reaching FL280

 BIGJET 347

NOTE: For passing instructions/reports regarding height/altitude or flight level, use CLIMB(ING), DESCEND(ING), PASSING, REACHING or LEAVING but *not* CLEARED/RE-CLEARED.

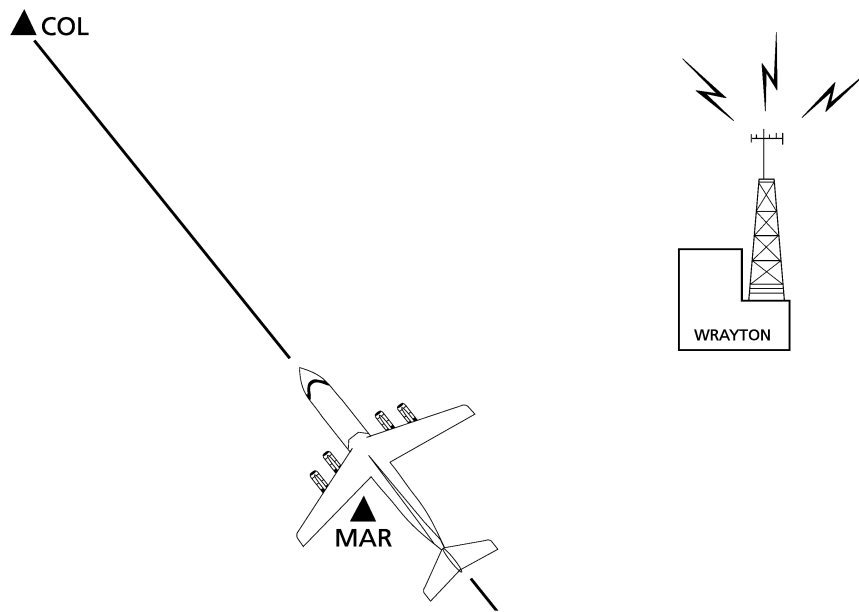



Figure 12 IFR – Position Report

 BIGJET 347, Marlow 08 FL280
Colinton 48

 BIGJET 347

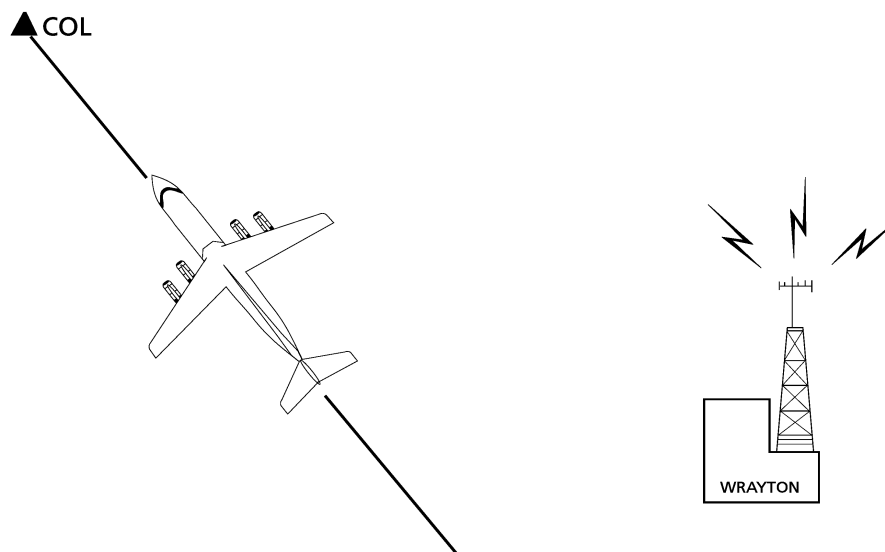





Figure 13 IFR – Descent Clearance

 BIGJET 347, request descent

 BIGJET 347, descend FL120 cross
Colinton FL170 or above

 Descending FL120 will cross
Colinton FL170 or above,
BIGJET 347

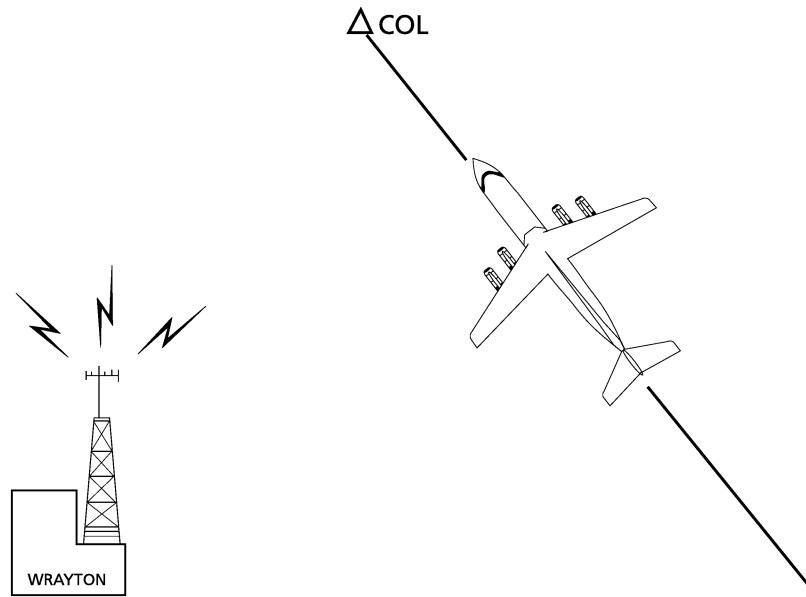
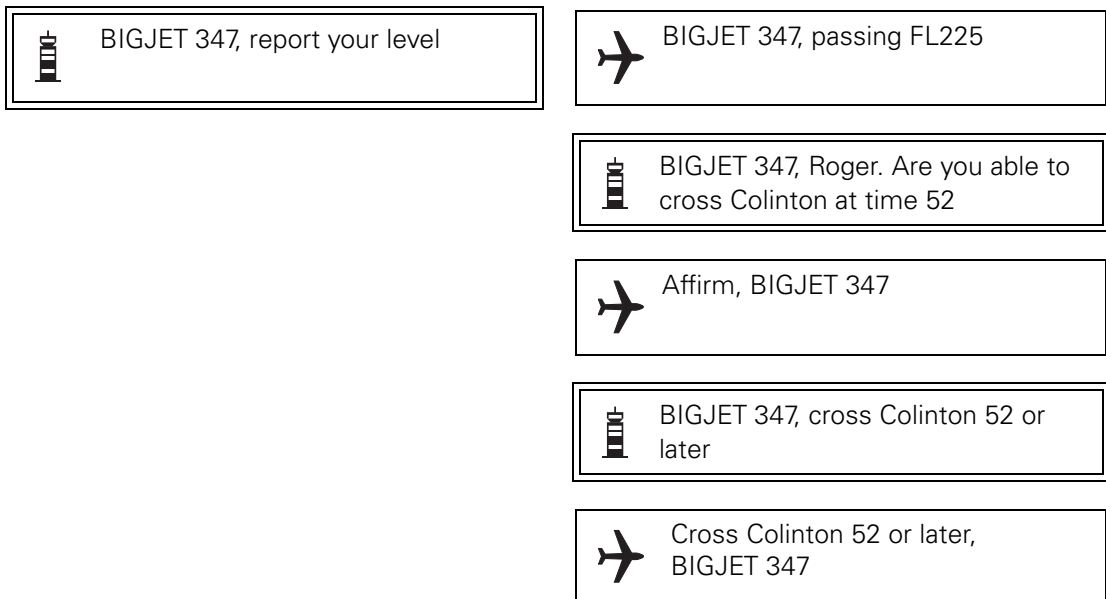

Figure 14 IFR – ATC Request and Instruction



NOTE: AFFIRM/NEGATIVE are used when a question requires a direct answer.

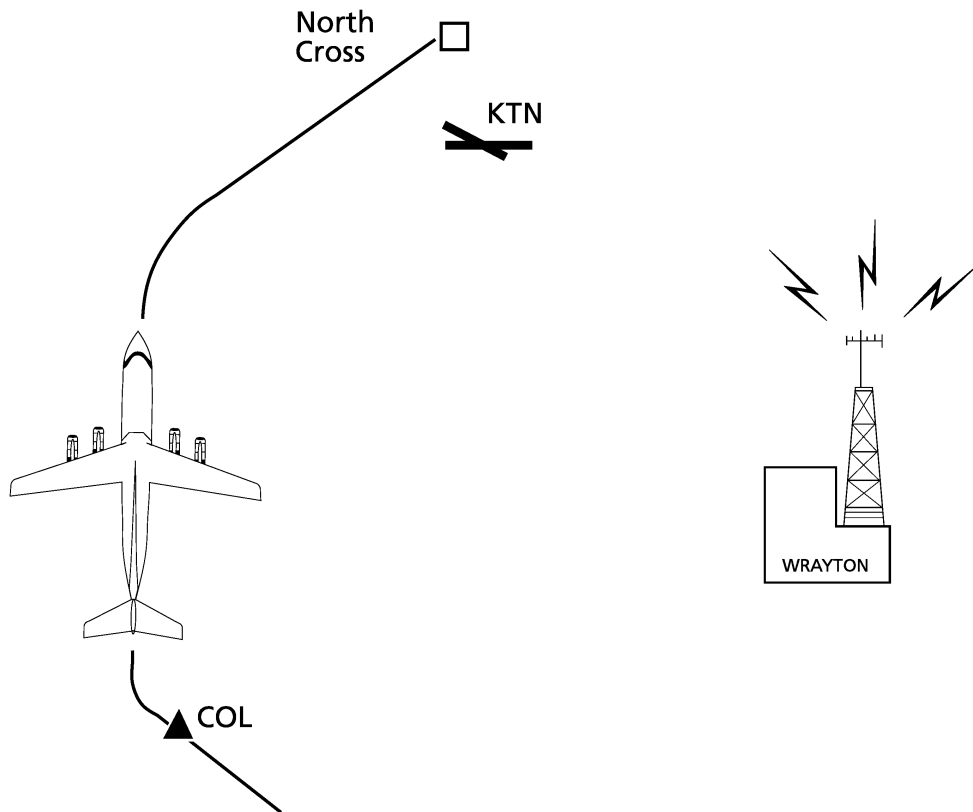





Figure 15 IFR – Pilot Request

 BIGJET 347, Colinton 52 FL180 descending FL120 request direct North Cross for ILS approach at Kennington

 BIGJET 347, Roger. Route direct to North Cross. Descend FL60. Report West abeam KTN

 Direct North Cross descend FL60. Wilco, BIGJET 347

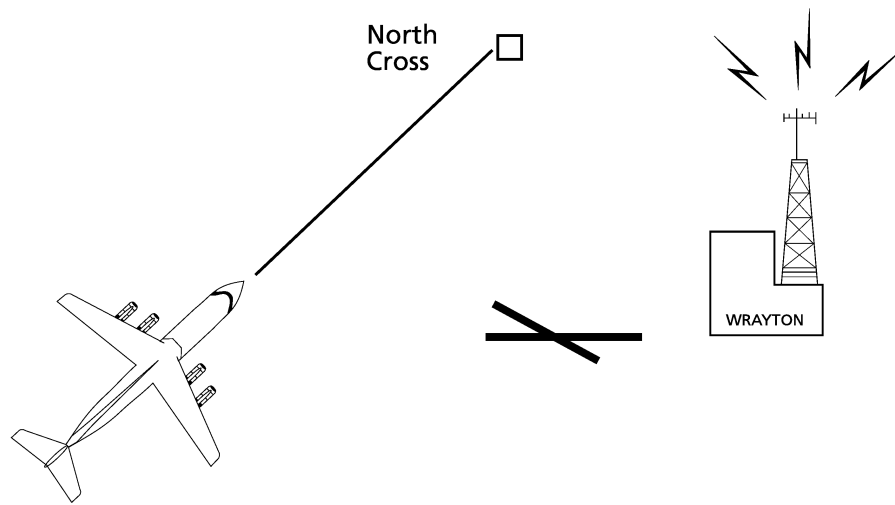





Figure 16 IFR – Descent to FL100

 BIGJET 347, West abeam
Kennington 03 FL100 descending
FL60 North Cross 11

 BIGJET 347, Roger. Contact
Kennington Approach 119.750

 Kennington Approach 119.750,
BIGJET 347

NOTE: FL100 spoken as “flight level WUN HUN DRED”

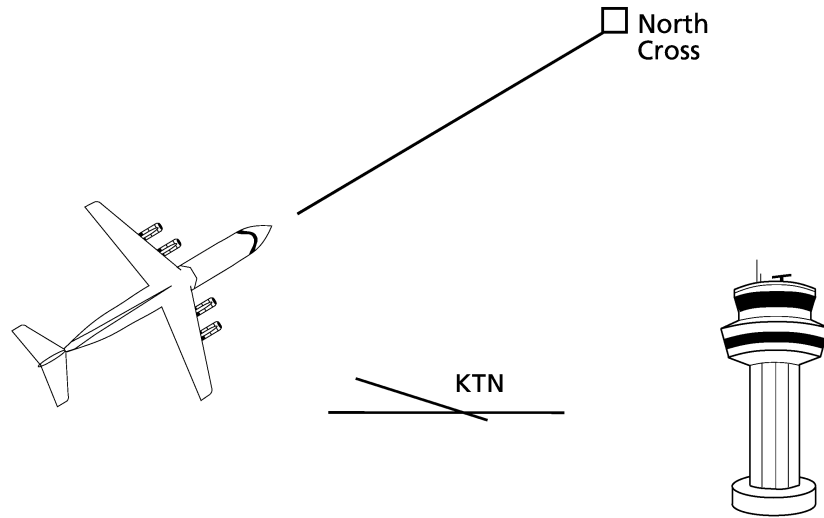
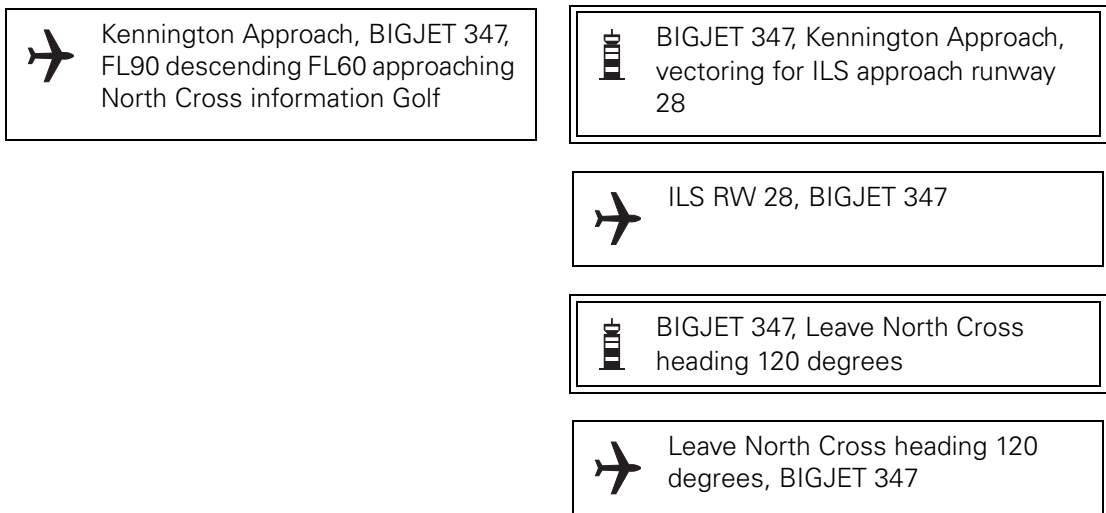

Figure 17 IFR – Contacting Approach Control



NOTE: Full readback of HEADING (and speed) instructions; also runway identifier.

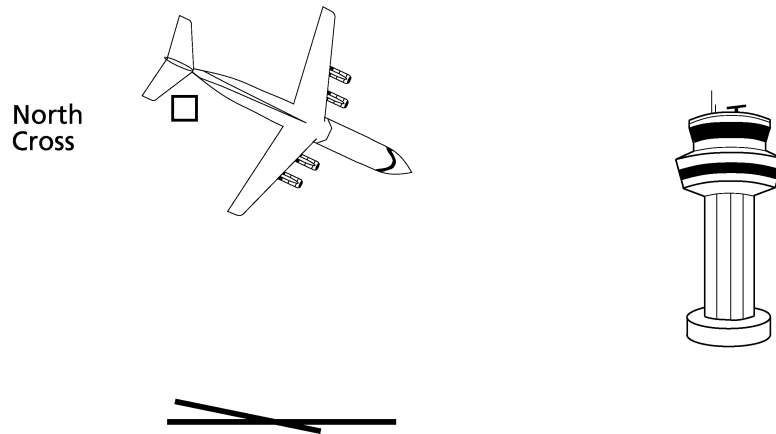







Figure 18 IFR – Vectoring for Approach

 BIGJET 347, North Cross FL60 heading 120 degrees

 BIGJET 347, descend to altitude 2500 feet QNH 1011

 Descend to altitude 2500 feet QNH 1011, BIGJET 347

 BIGJET 347, position 10 miles northeast of Kennington

 BIGJET 347

 BIGJET 347, turn right heading 190 degrees base leg 14 miles northeast of Kennington

 Right heading 190 degrees, BIGJET 347

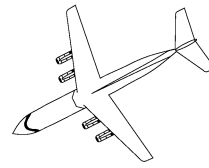
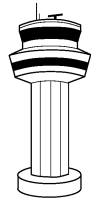
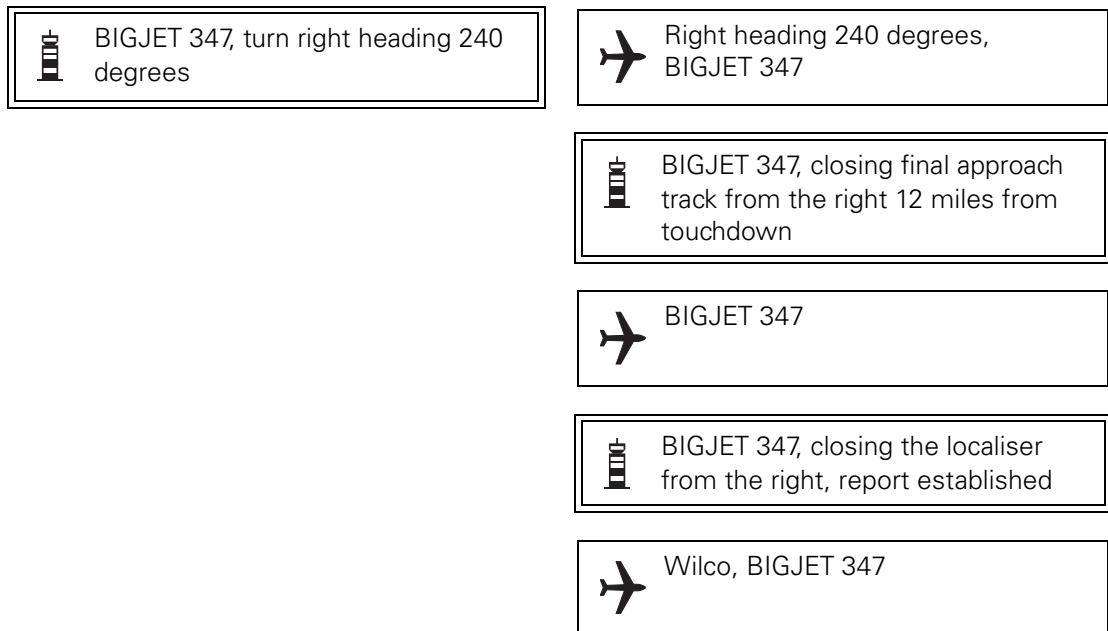

Figure 19 IFR – Intercepting the Localiser



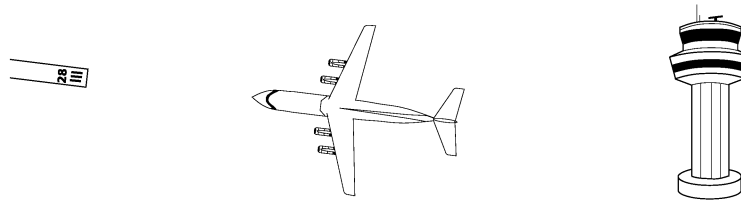
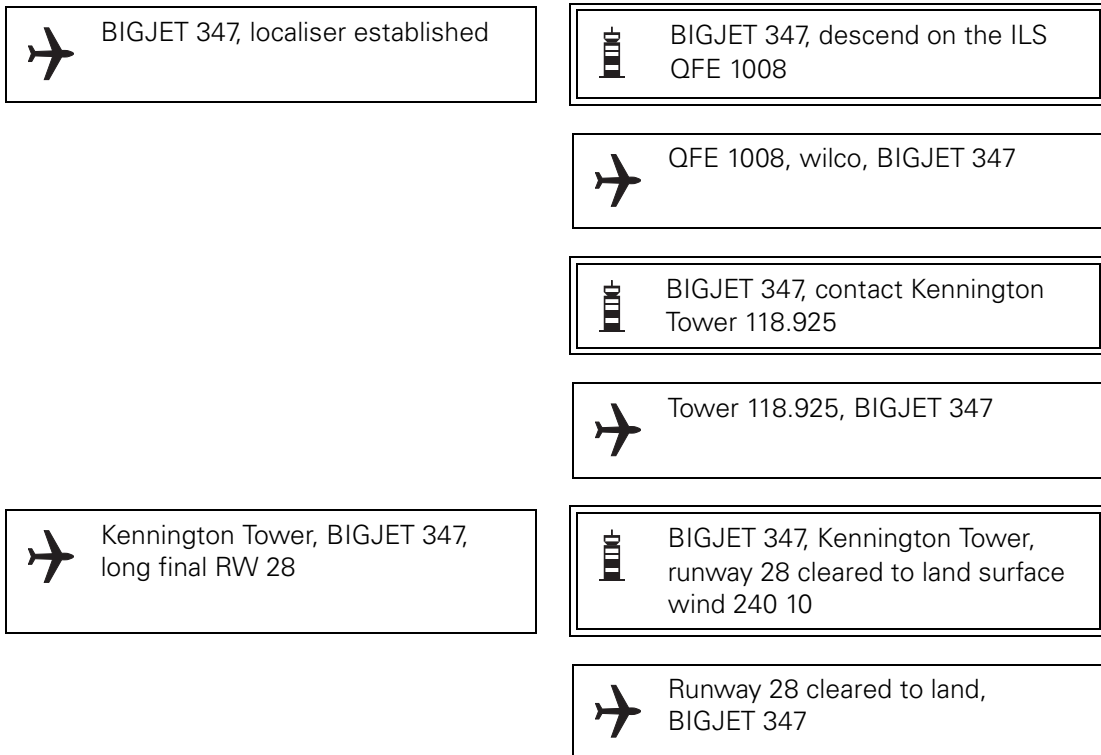

Figure 20 IFR – Landing Clearance



NOTE: Surface wind: 'Degrees' and 'Knots' may be omitted.

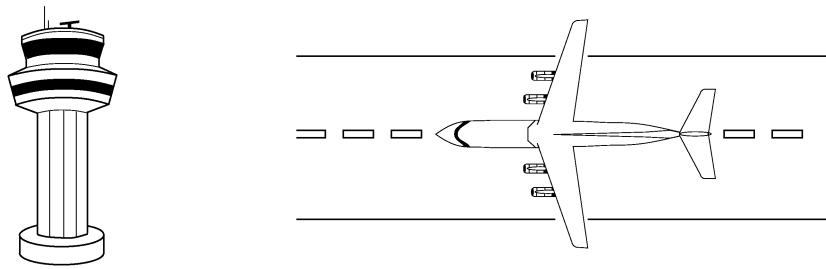

Figure 21 IFR – Vacate the Runway

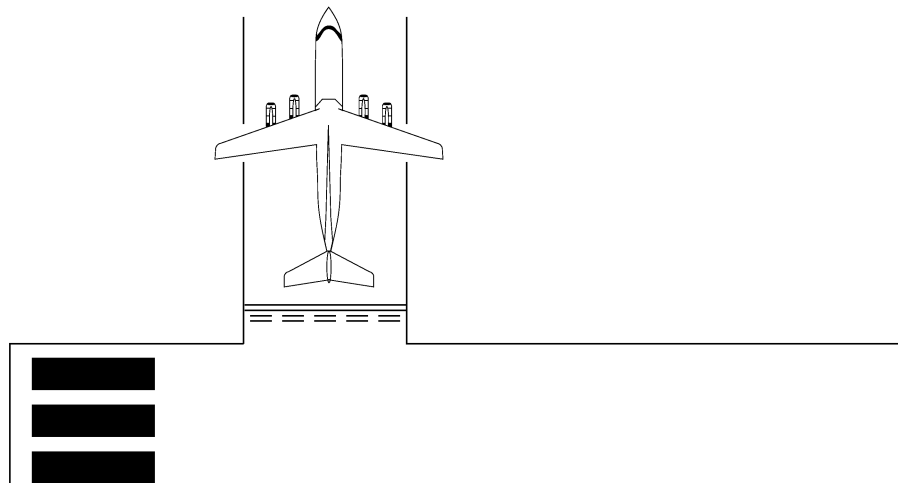
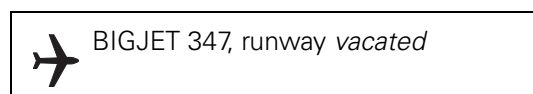

Figure 22 IFR – Runway Vacated



NOTE: VACATE runway and *not* CLEAR runway.

1.3 **A VFR/IFR Flight**

1.3.1 This particular example is aimed at the pilot flying outside controlled airspace under services provided by the military in the UK (Westbury) to show the slight differences that exist from civil ATS as portrayed in previous Chapters.

1.3.2 **Engine Start and Departure Information**

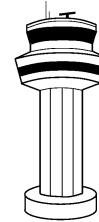
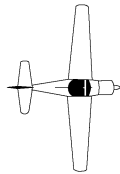
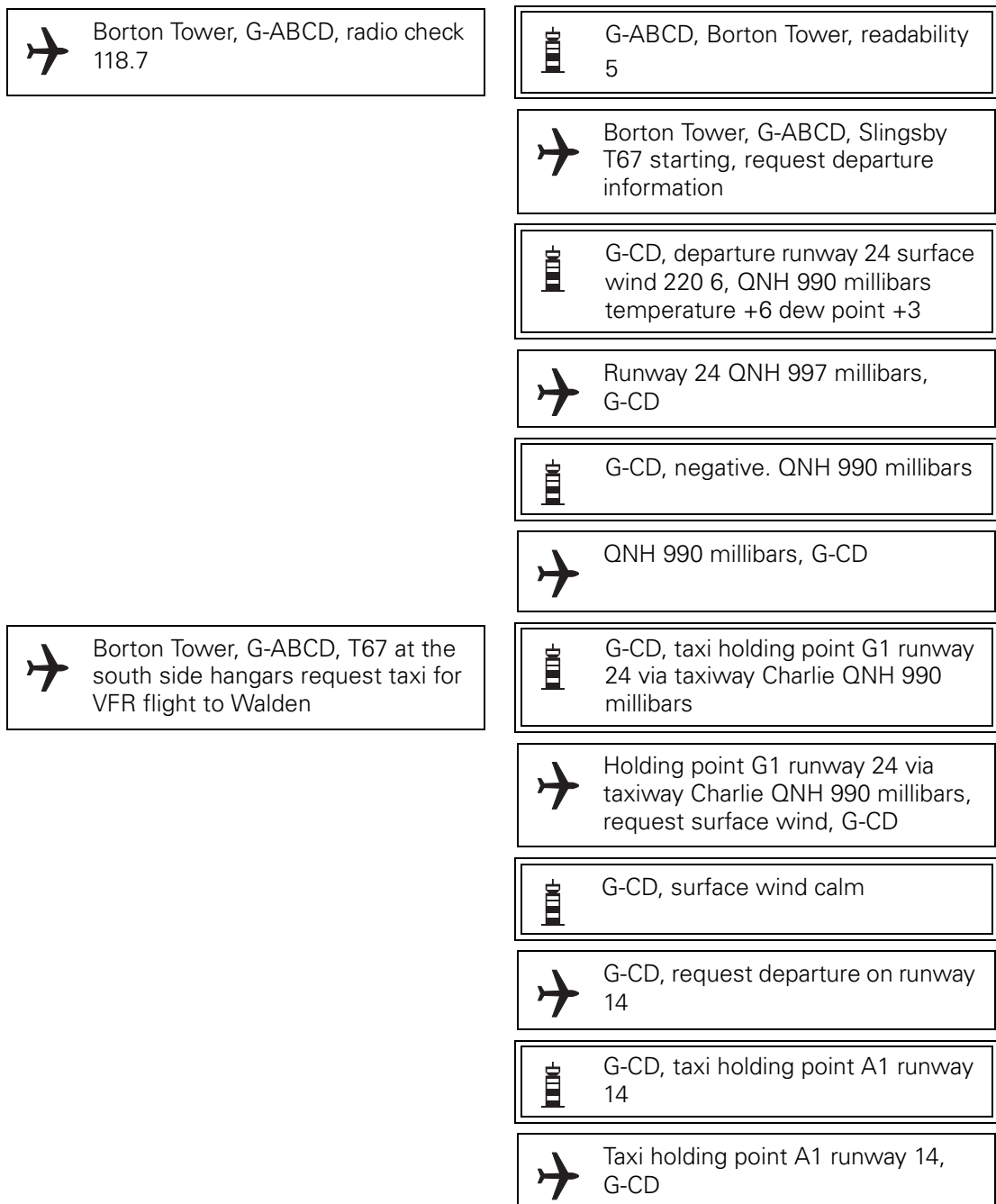

Figure 23 VFR – Start up and Taxi



1.3.3 Pre-departure and Take-off

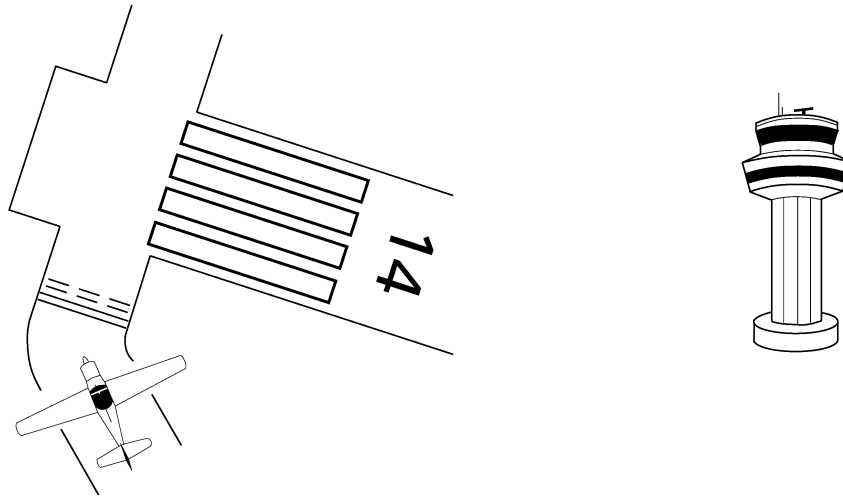
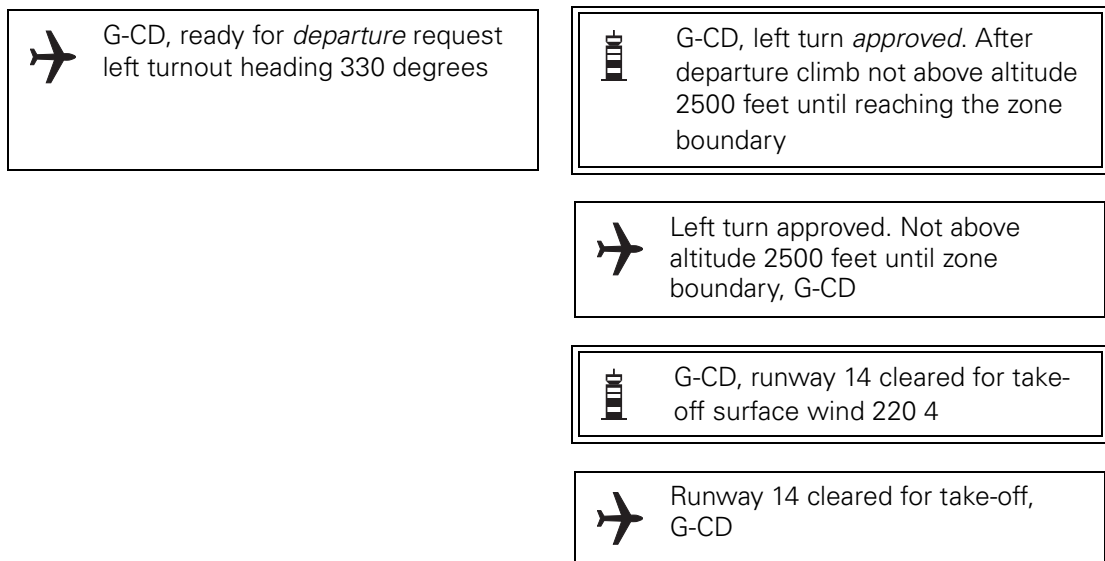

Figure 24 VFR – Departure Instructions and Take-off Clearance



NOTES:

- 1 DEPARTURE used not TAKE-OFF.
- 2 APPROVED used not CLEARED.
- 3 Full readback of departure clearance.
- 4 Runway identified as in this case it is not the runway in use.
- 5 Readback of take-off clearance.

1.3.4 Post Departure Flight

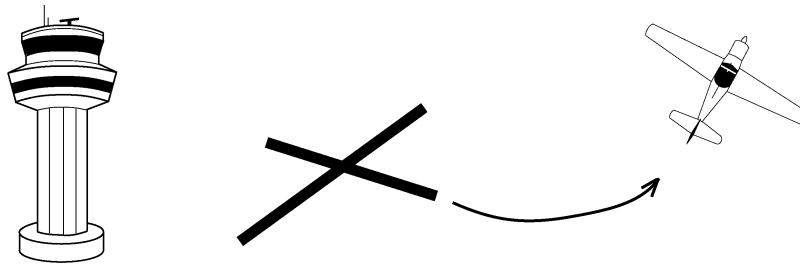
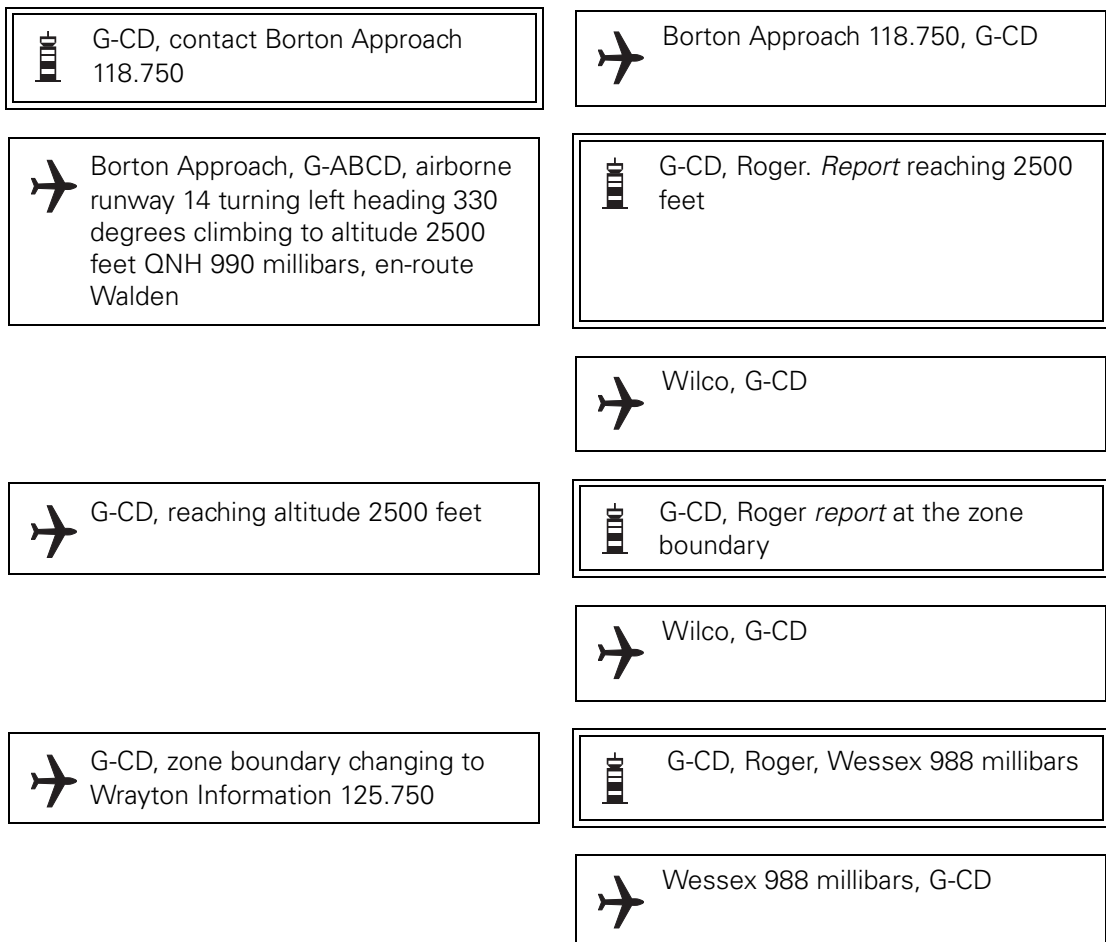
**Figure 25** VFR – Departure Report**NOTES:**

- 1 REPORT introduced.
- 2 CHANGING TO announces intention to change frequency.
- 3 Transmission of WESSEX Regional Pressure Setting is limited to regional name and pressure.

1.3.5 En-route Flight

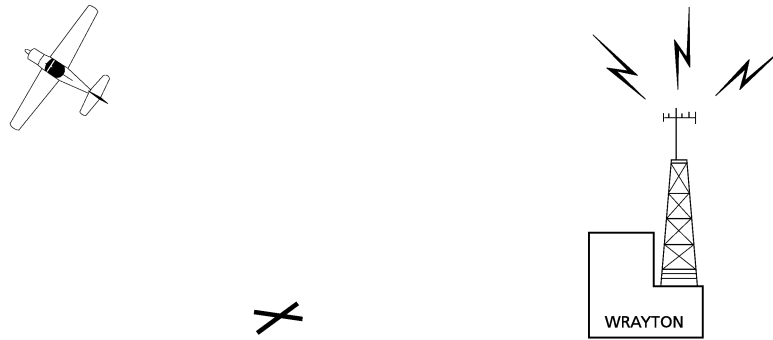
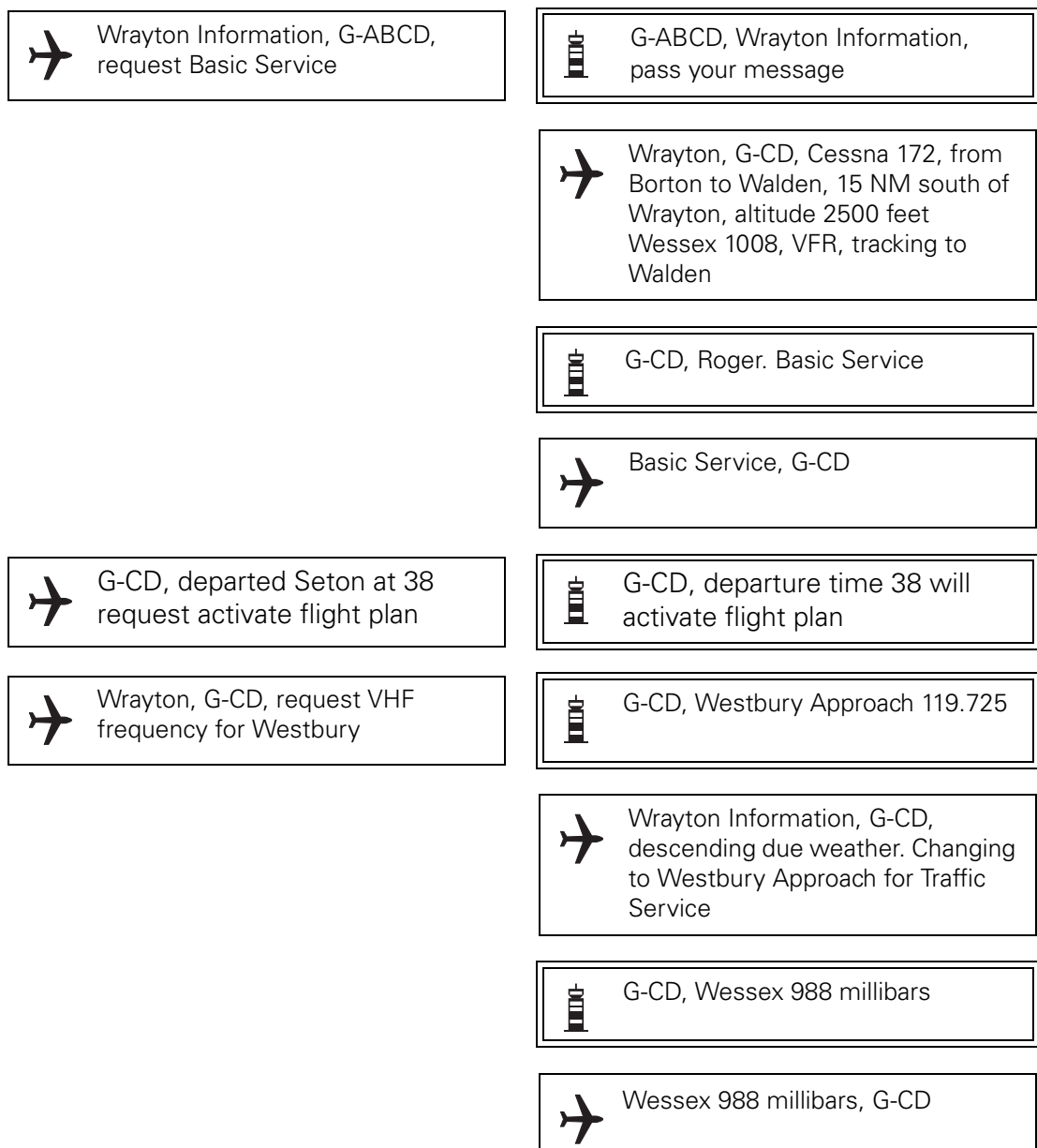

Figure 26 VFR – Request for Basic Service



1.3.6 **Flight Receiving Lower Airspace and MATZ Penetration Service**

NOTE: Westbury is a military unit.

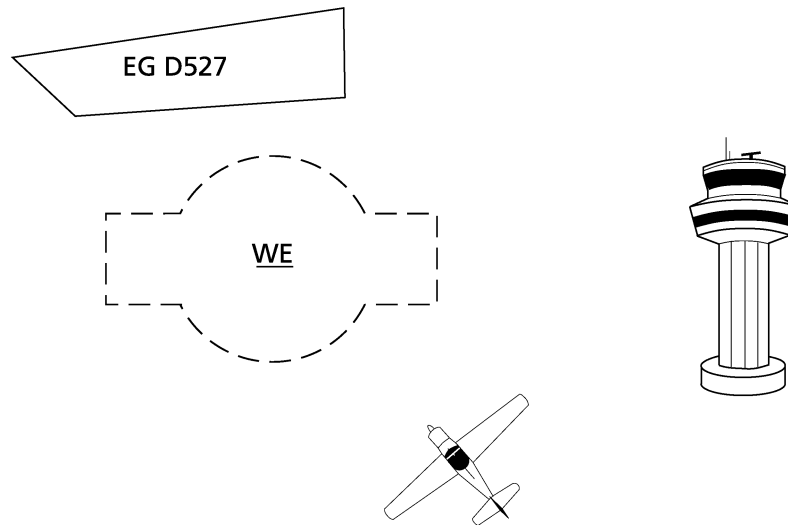
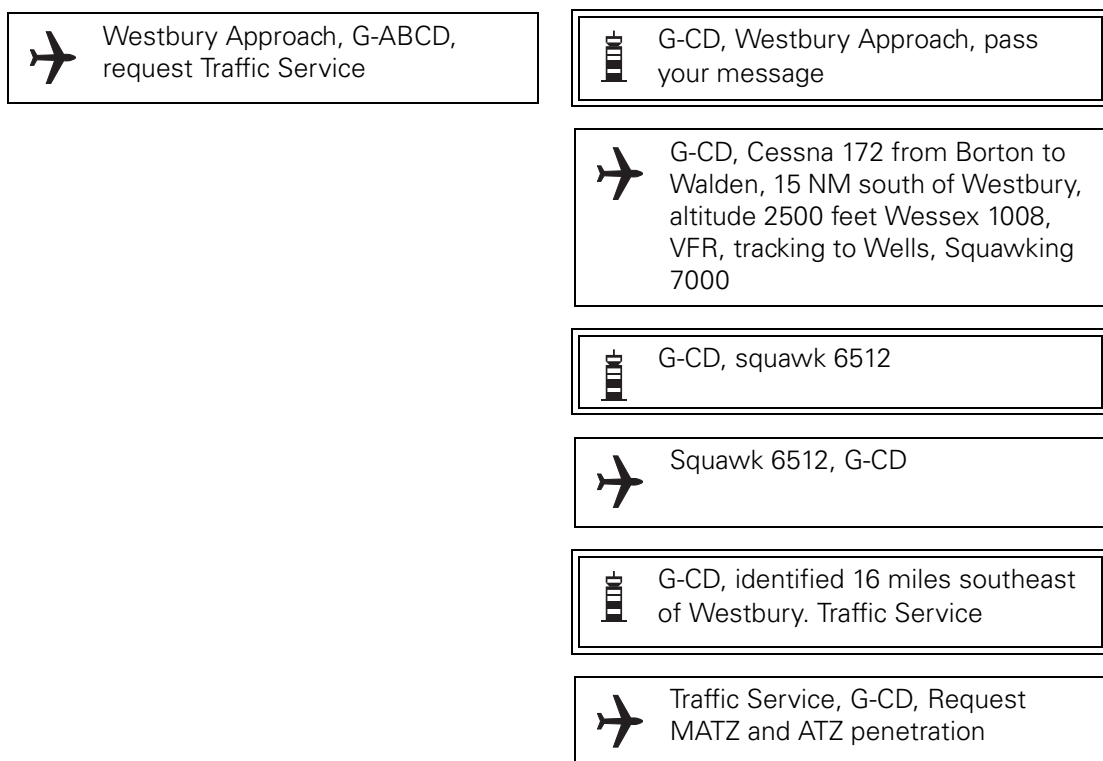

Figure 27 VFR – LARS Traffic Service Request



NOTE 1: Details of LARS and MATZ Penetration Service can be found in the UK AIP, AICs and Temporary Supplements.

NOTE 2: When crossing a CMATZ it is the responsibility of the pilot to ensure that permission is obtained to transit each individual ATZ embedded therein. The pilot, in his request to transit the CMATZ, may ask the controller to obtain such permission on his behalf. When issuing any approval to cross a CMATZ controllers will, where appropriate, articulate clearly any permission or otherwise to transit embedded ATZs.

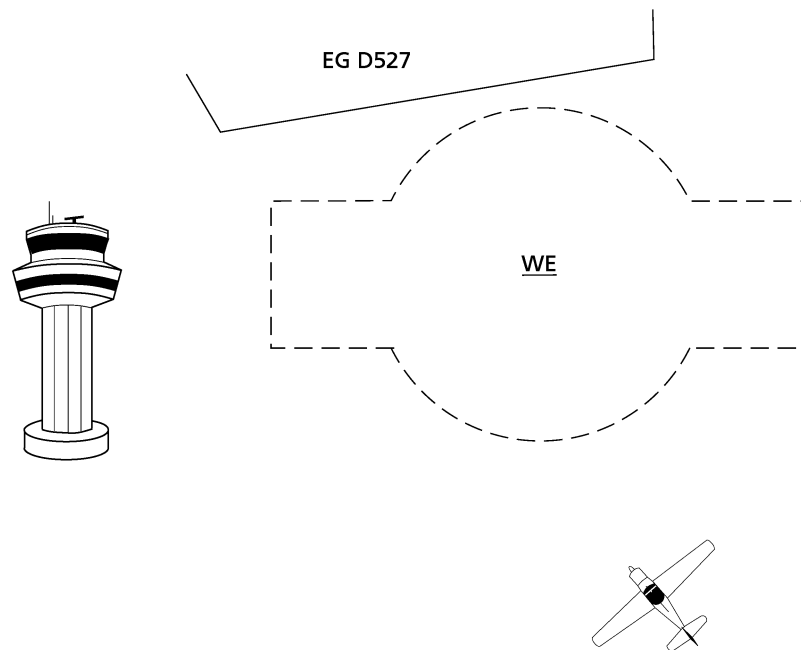
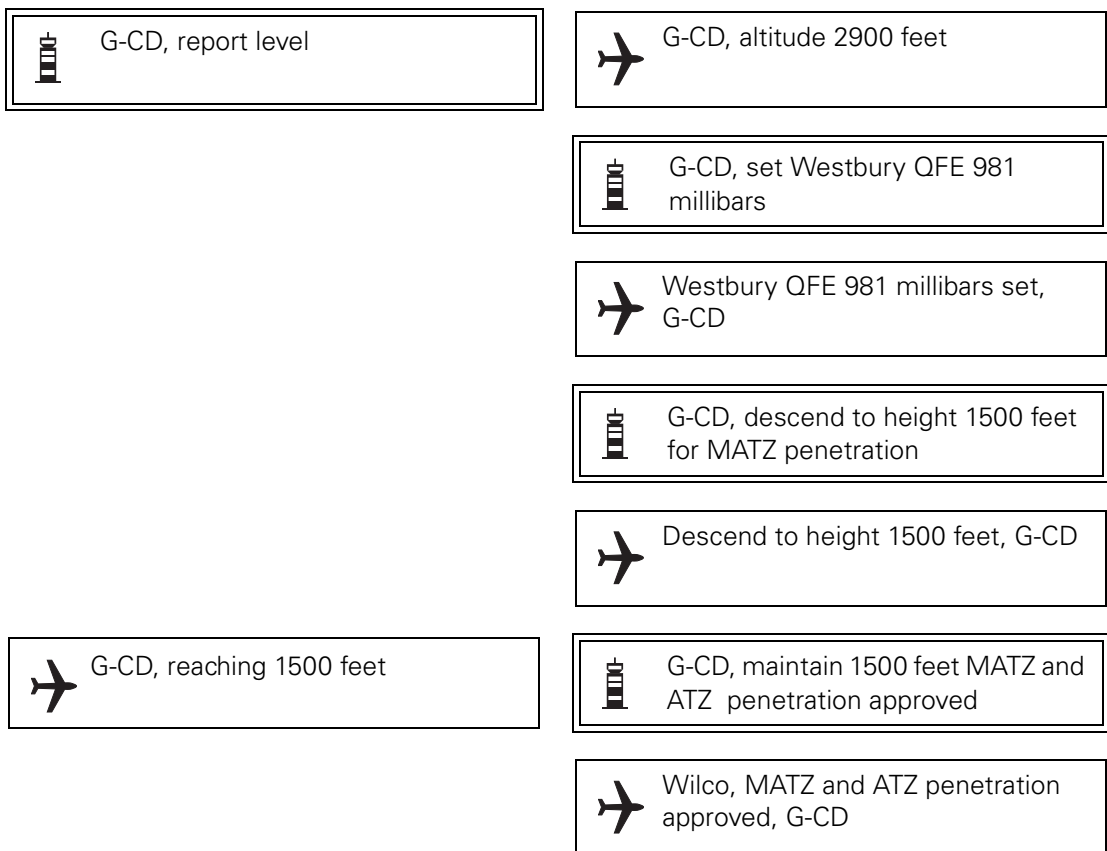

Figure 28 VFR – MATZ and ATZ Penetration



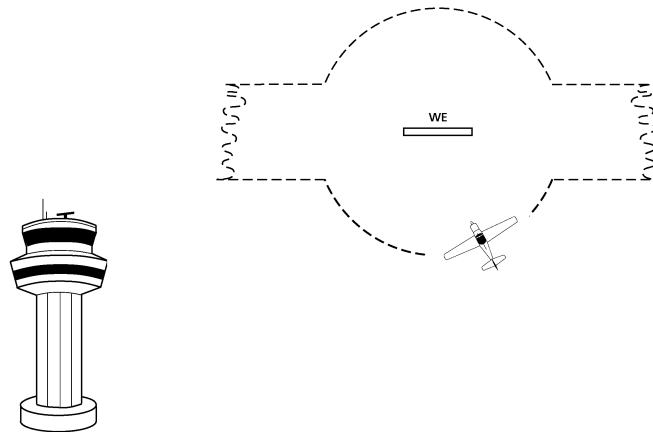













Figure 29 VFR – Join Request

 G-CD, entering MATZ reduced traffic information from ahead as you approach my radar overhead	 G-CD, Roger. Request join for one visual circuit
 G-CD, Roger. Standby	
 G-CD, one visual circuit approved maintain 1500 feet to overhead. Do you have the field in sight?	
 Maintain 1500 feet to overhead. G-CD has the field in sight	
 G-CD, roger. Runway 27 right hand circuit height 1000 feet QFE 981 millibars	
 Runway 27 right hand circuit height 1000 feet QFE 981 millibars, G-CD	
 G-CD, request POB	
 1 POB, G-CD	
 G-CD, contact Westbury Tower 132.850	
 Westbury Tower 132.850, G-CD	

NOTES:

- 1 The question of landing fees etc. is not addressed in this scenario.
- 2 Circuit direction is only given when circuit is not left-hand.
- 3 Military units employ QFE in the circuit area, the instrument pattern and for MATZ penetration.
- 4 POB – Total number of People on Board.

1.4 **Flight in the Military Visual Circuit**

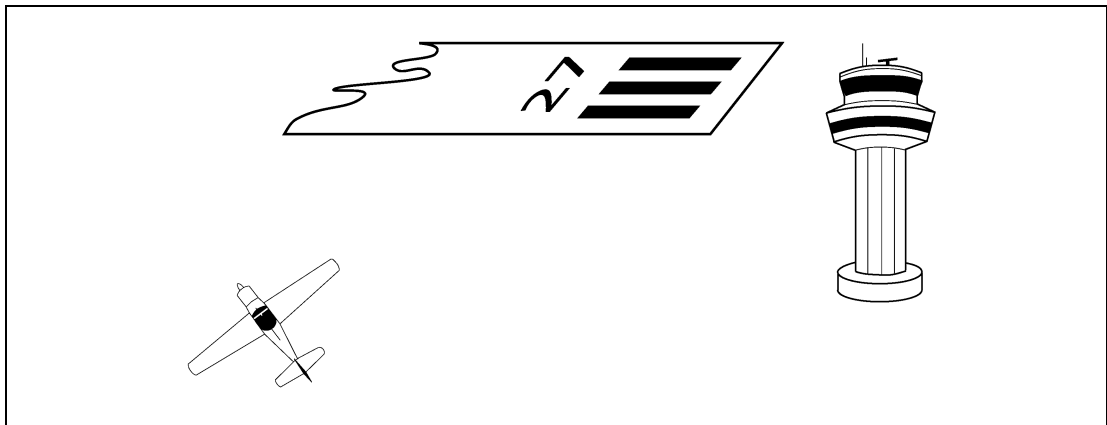







Figure 30 VFR – Circuit Join

 Westbury Tower, G-ABCD, 2 miles southeast height 1500 feet QFE 981 millibars to join for one visual circuit

 G-CD, Westbury Tower, join overhead at 1500 feet for runway 27 right hand QFE 981 millibars circuit clear

 Join overhead 1500 feet runway 27 right hand QFE 981 millibars, G-CD

 G-CD, overhead 1500 feet

 G-CD, report downwind at 1000 feet one fast jet joining base leg to land

 Wilco, G-CD

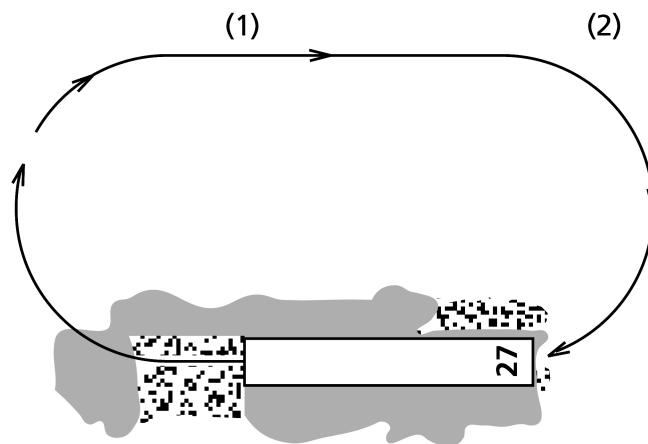

Figure 31 Military Visual Circuit Pattern

NOTES:

- 1 Downwind report is made abeam upwind end of runway. Aircraft intentions are stated here.
- 2 'Final' call is made *just before turning base leg*.
- 3 Military (jet) circuits tend to be relatively tight and are more oval-shaped.
- 4 Military use 'two in', 'three in' etc. for number of aircraft present in the visual circuit.

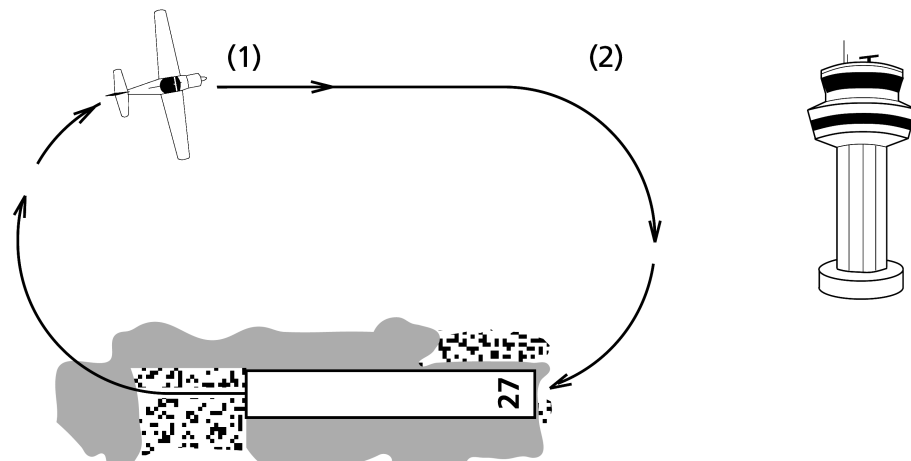





Figure 32 VFR – Downwind, DACS Request

(1)

 G-CD, downwind 1000 feet request touch and go then depart to the northwest. Request Crossing Service for Danger Area 512

 G-CD, surface wind 250 5 one ahead to land. DACS request copied

(2)

 G-CD, final gear down

 G-CD, go around 500 feet deadside one on remaining

 Go around 500 feet deadside, G-CD

NOTES:

- 1 Surface wind is passed at downwind position.
- 2 An aircraft with retractable undercarriage will be expected to call 'gear down' or three greens with the final call.
- 3 'Go Around' see Chapter 10, paragraph 3.17 and Chapter 4, paragraph 1.10.1.

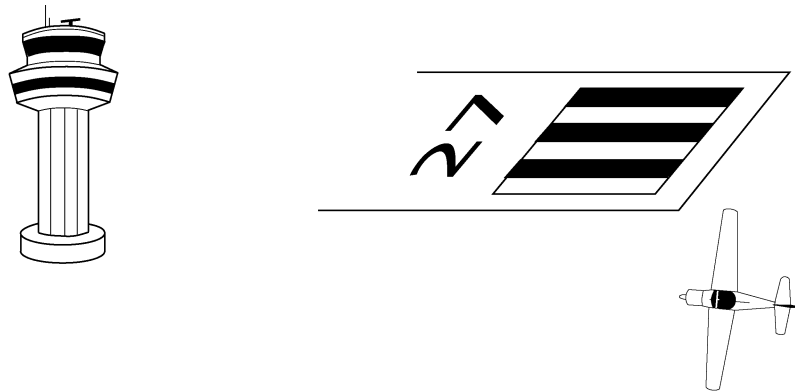



Figure 33 IFR – Departure Instructions

 G-CD, at upwind end of runway turn right heading 295 climb to height 2000 feet QFE 981 millibars





 Upwind end of runway right heading 295 climb to height 2000 feet QFE 981 millibars, G-CD



Figure 34 IFR – Departure Report

 G-CD, heading 295 climbing to height 2000 feet

 G-CD, contact Westbury Approach 119.725

 Westbury Approach 119.725, G-CD

NOTE: Full readback of clearance and frequency change.

1.5 Flight Receiving Lower Airspace Radar Service (LARS) and Danger Area Crossing Service (DACS)

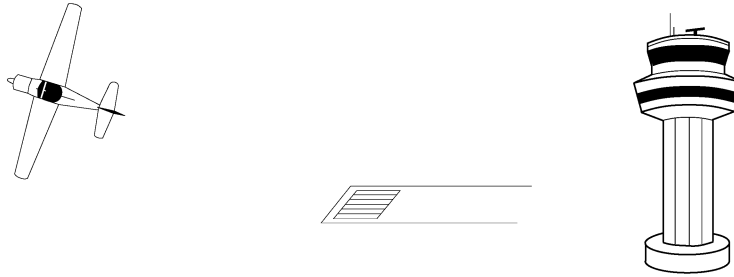
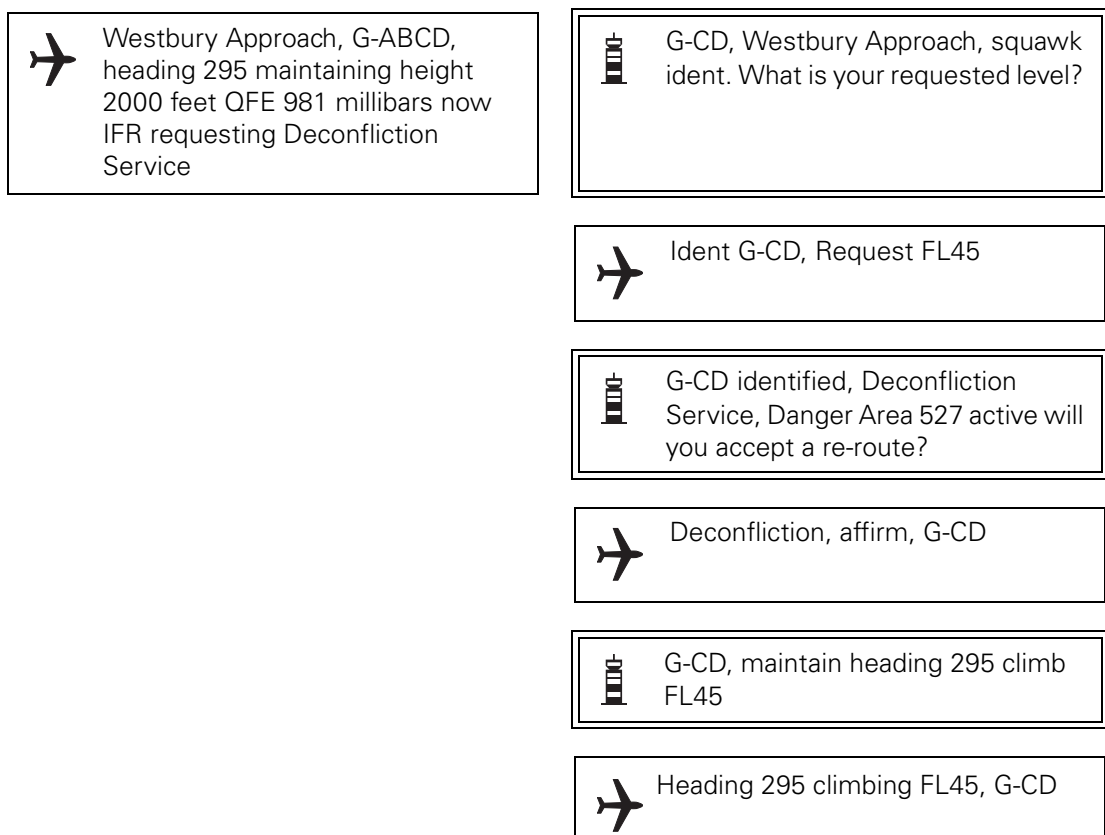

Figure 35 VFR – Requesting Deconfliction Service



NOTES:

- 1 AFFIRM used.
- 2 Military controllers use 'MAINTAIN' heading.

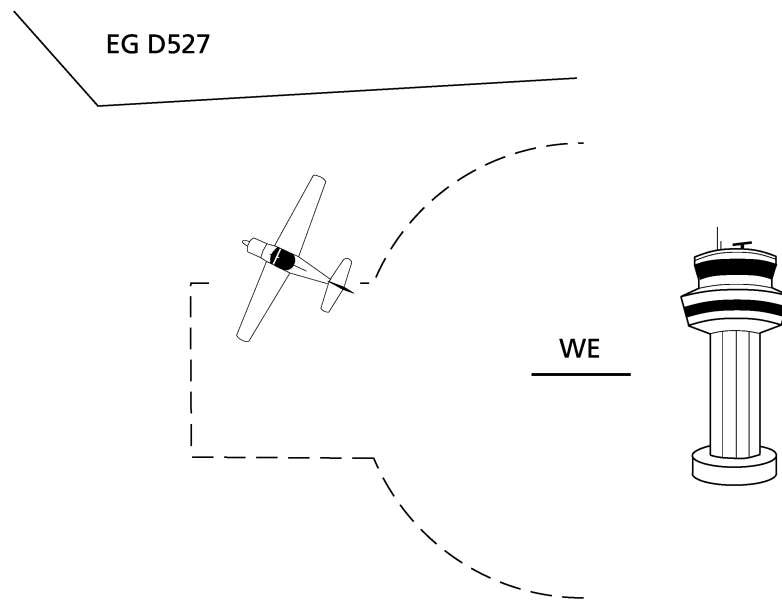
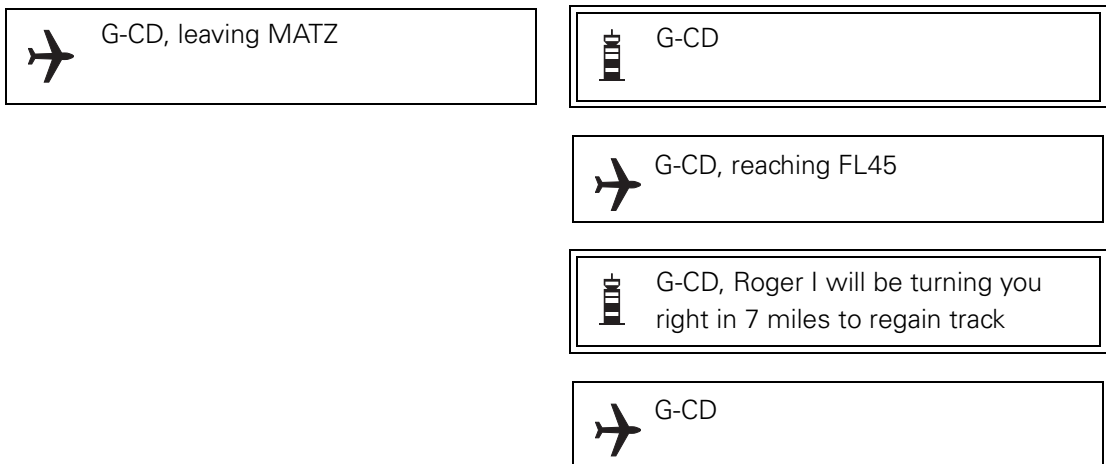

Figure 36 VFR – Report Leaving a MATZ



NOTE: Report leaving a MATZ.

1.6 Military Safety Broadcast – Sécurité

For details of the broadcast message 'SECURITÉ' see Chapter 10 paragraph 3.33.

1.7 Callsign Prefix – 'STUDENT'

- 1.7.1 On initial contact with Air Traffic Service Units (ATSUs) (including ATC centres and aerodromes providing an ATC service, an Aerodrome FIS (AFIS) or an AGCS), student pilots who do not yet hold a licence and who are flying solo as part of their training are to prefix the aircraft callsign with the word "STUDENT"¹. Once acknowledged, it will not normally be necessary for student pilots to use the prefix in subsequent transmissions until making initial contact with other ATSUs, unless they feel they are being instructed to do something with which they are unfamiliar.
- 1.7.2 ATS personnel will acknowledge the initial call, again using the prefix, and can be expected, in so far as is practicable, to make due allowance for the limited experience and ability of student pilots in determining the pace and complexity of instructions and/or information which are subsequently passed.
- 1.7.3 A solo student pilot experiencing an emergency and communicating with a military unit or the D&D Section shall use the 'STUDENT' prefix with the aircraft callsign as part of the distress or urgency message. A military ground station or the D&D section receiving a distress or urgency message from a student pilot may use this information on pilot experience to render the most appropriate assistance. (See also Chapter 8, Emergency Phraseology, paragraph 1.5.)

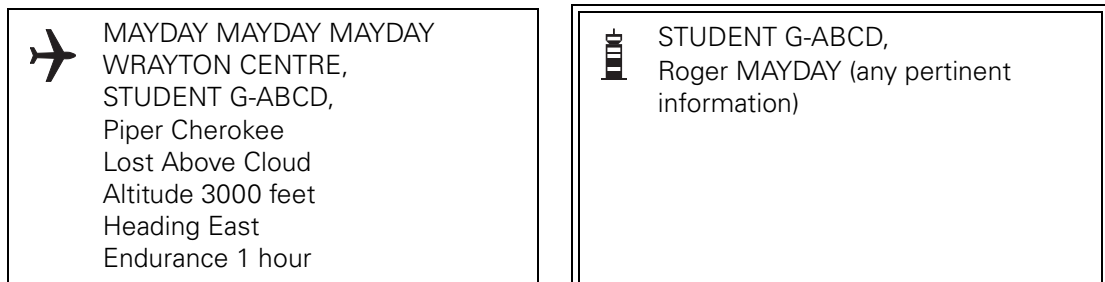

Figure 37 Callsign Prefix 'STUDENT'

1. Although intended primarily for use by ab initio students, the prefix shall also be used in other circumstances where, for example, the holder of a valid licence is returning to flying practice after a significant absence and is undergoing renewal training involving solo flight conducted as a student under the supervision of a flight instructor.

1.8 Flight Receiving Avoiding Action

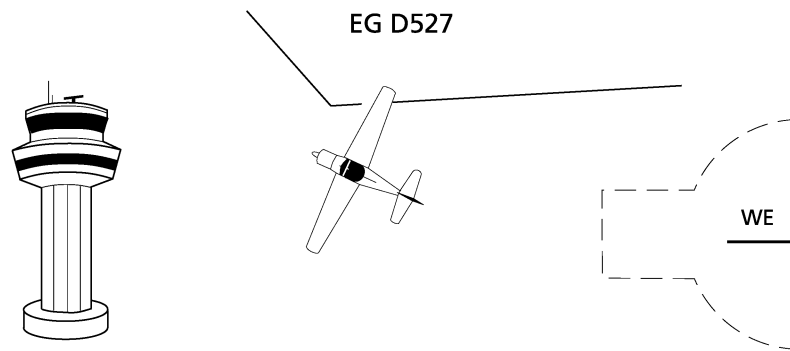



Figure 38 Avoiding Action

 G-CD, avoiding action, turn left immediately heading 230 degrees pop-up traffic 12 o'clock 6 miles opposite direction no height information

 Left heading 230 degrees, G-CD

NOTES:

- 1 This type of avoiding action when under Deconfliction Service is given at the controller's discretion for late sighting/pop-up traffic.
- 2 An unknown traffic call can be expected as follows: G-CD unknown traffic 11 o'clock 6 miles crossing left to right no height, if not sighted turn left heading 230 degrees.

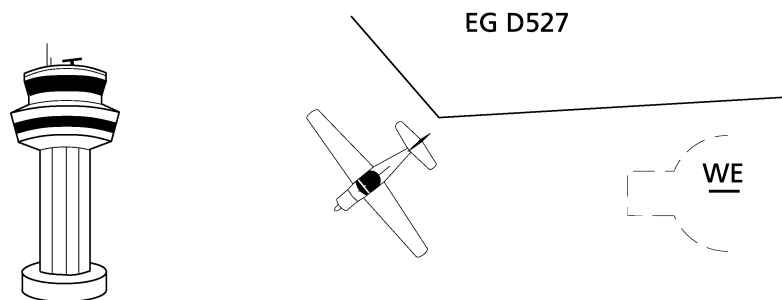





Figure 39 Clear of Traffic

 G-CD, clear of traffic, turn right heading 340 degrees direct for Walden

 Right heading 340 degrees. Request change to Wrayton Information 125.750, G-CD

 G-CD, squawk 7000 Freecall Wrayton Information 125.750

 Squawk 7000, G-CD

1.9 Flight Receiving En-Route Basic Service

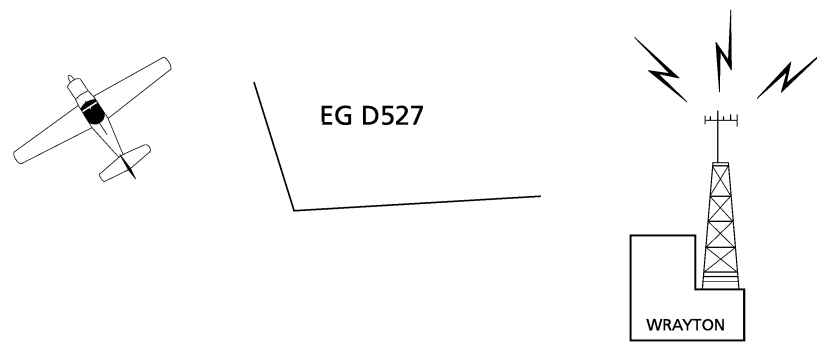
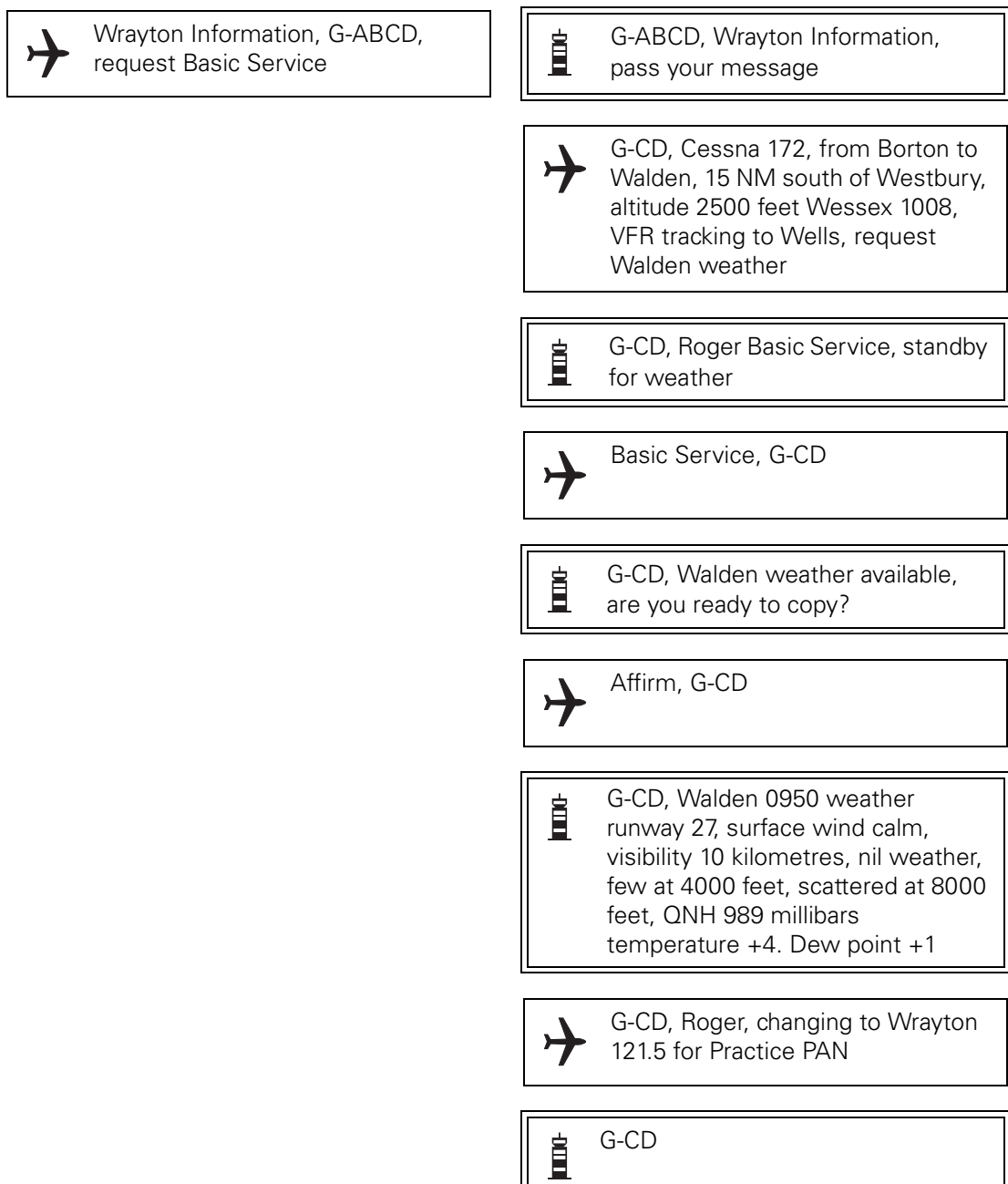
**Figure 40** VFR – En-route Reply to Pass Your Message

1.10 Flight Transmitting a Practice Pan (121.5 – listen out before transmitting)



Figure 41 Practice Pan Call

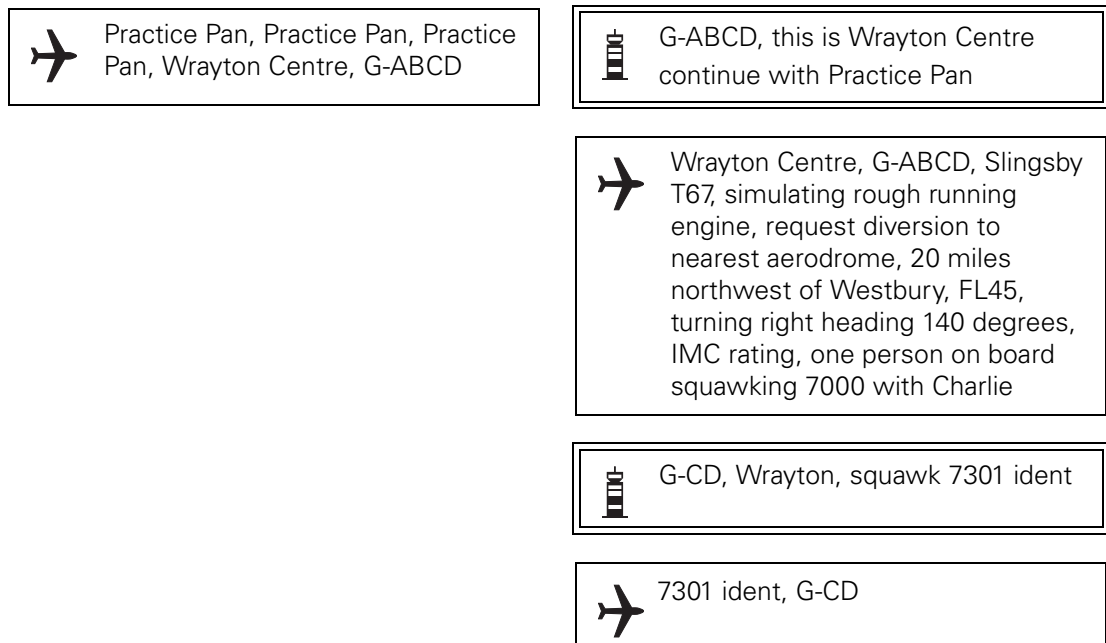

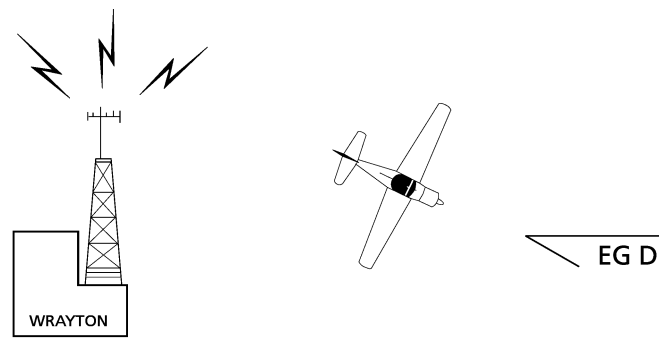
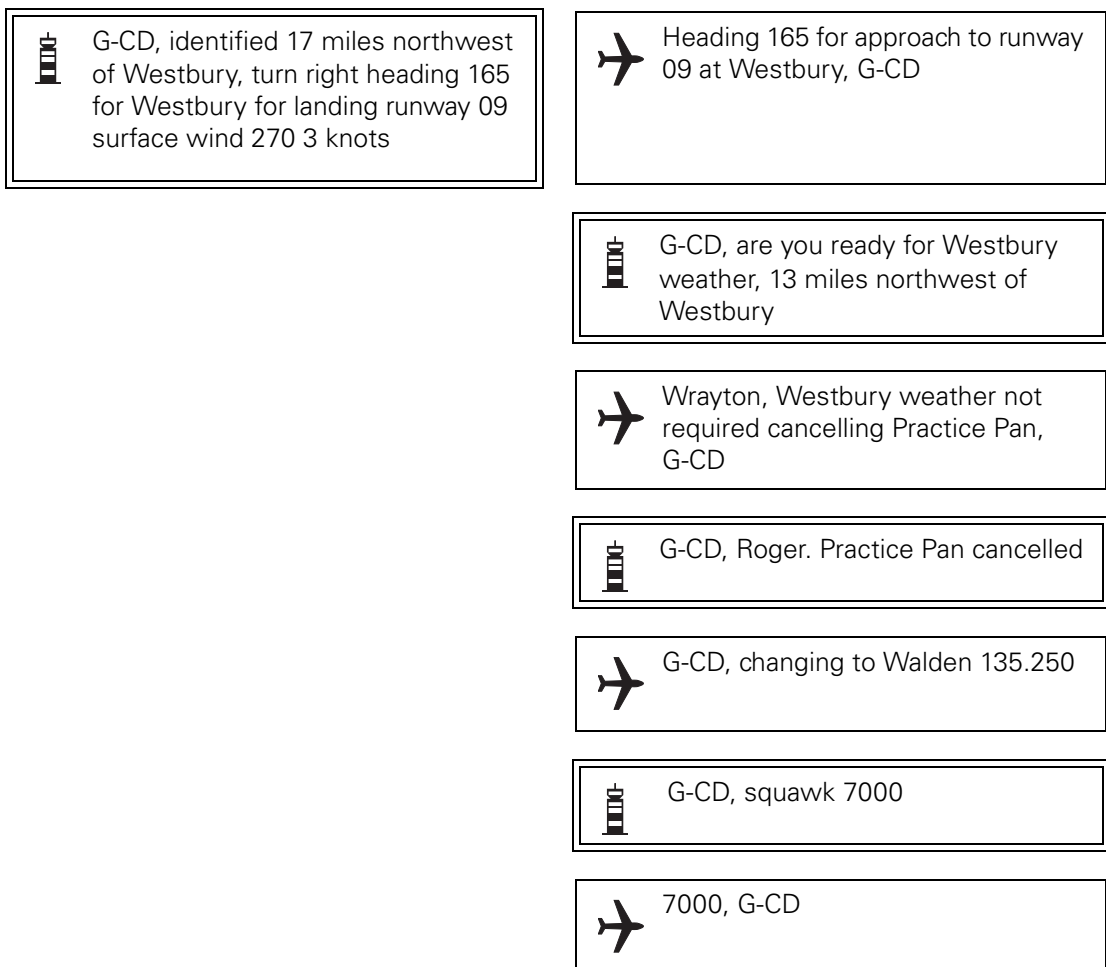

Figure 42 VFR – Practice PAN – Radar Identification



NOTE 1: Use of the VHF International Emergency Service is detailed in the UK AIP and AICs and Chapter 8, Emergency Phraseology.

NOTE 2: Controllers are not required to pass position information when using SSR to identify an aircraft in uncontrolled airspace. However, controllers may pass position information to aircraft whenever they consider it necessary.

1.11 Arrival Flight (Aerodrome FIS)

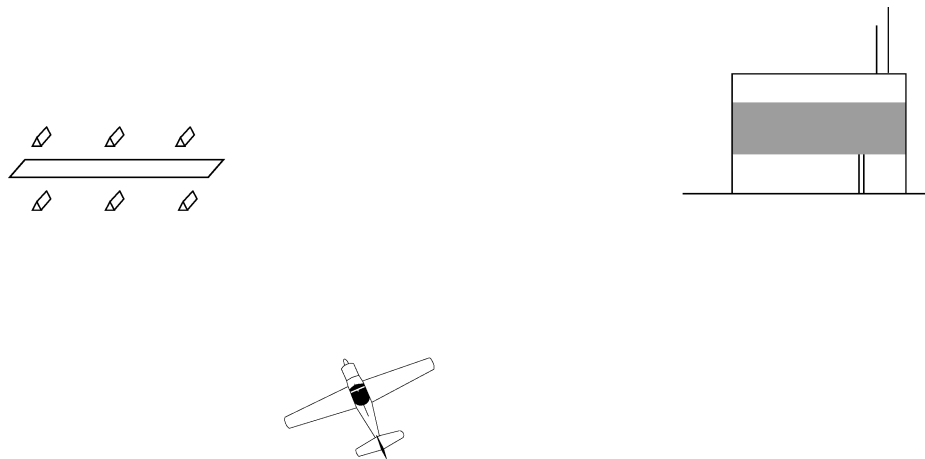
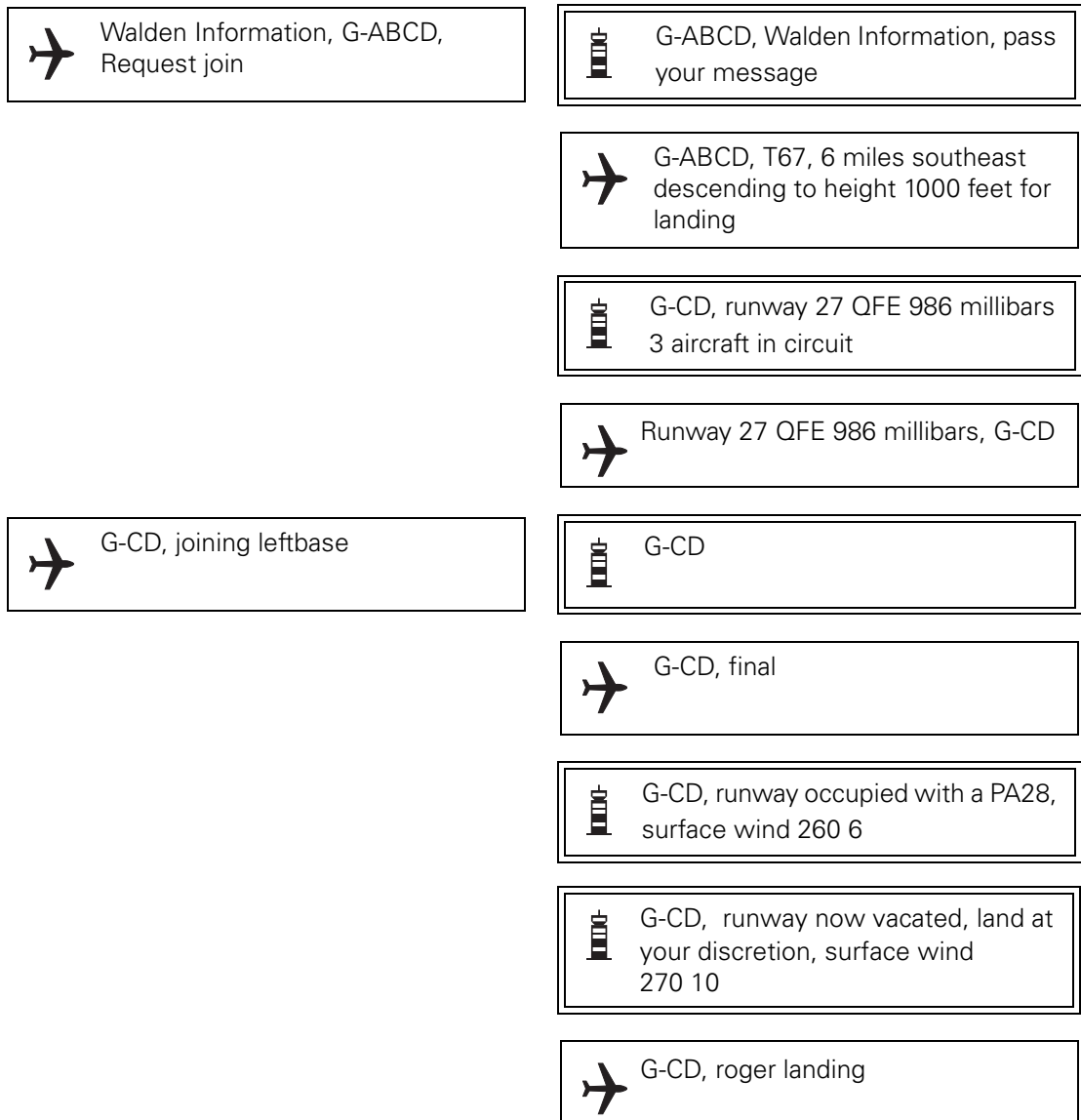

Figure 43 VFR – AFIS Arrival





G-CD



G-CD, runway vacated

NOTES:

- 1 Joining **Information** is provided by FISOs at aerodromes and the pilot should position accordingly.
- 2 Joining **Instructions** are only issued where an **ATC** service is provided.
- 3 When taking off or landing, the pilot should state his intention when options are available e.g. landing/going around, taking off/holding position.

Appendix 1 UK Differences to ICAO Radiotelephony Procedures

- 1 ICAO sets out standard international phraseology for communications between air traffic services and pilots in several documents including Annex 10 Volume 2 (Communications Procedures) to the Convention on International Civil Aviation and ICAO PANS-ATM (Procedures for Air Navigation Services – Air Traffic Management) Doc. 4444.
- 2 Where the ICAO standard phraseology may be misunderstood, or has weaknesses in the UK environment, different phraseology has been specified for use (and notified to ICAO). In the UK, air traffic service units and pilots are expected to comply with the phraseology and procedures described in main text of this document.
- 3 When communicating with air traffic service units in other States pilots should use phraseology and procedures set out by ICAO (subject to any differences notified by that State).
- 4 Significant differences between the ICAO standard phraseology and that specified for use in CAP 413 are described in the table (below).

Source/Additional Information	Details of ICAO/UK Difference	Reason/Remarks
Annex 10 See UK AIP GEN 1.7	Phraseology FLIGHT LEVEL ONE ZERO ZERO (ICAO) is not used in the UK. In the UK flight levels ending in hundreds are transmitted as HUNDRED e.g. FLIGHT LEVEL ONE HUNDRED.	To avoid potential confusion with adjacent flight levels and misidentification of cleared levels e.g. FLIGHT LEVEL ONE ZERO ZERO with FLIGHT LEVEL ONE ONE ZERO.
Annex 10 See UK AIP GEN 1.7	In the UK, the name of either the aircraft manufacturer, or name of the aircraft model, or name of the aircraft category (e.g. helicopter or gyrocopter) may be used as a prefix to the callsign.	To aid recognition by the ground station and/or other aircraft that the aircraft transmitting is of a particular category and may manoeuvre differently or require special handling.
Annex 10 See UK AIP GEN 1.7	In the UK CONTACT shall have the meaning “Establish communications with...(your details have been passed)” .	This shortens a pilot’s first call on the next ATS unit/frequency, as he/she knows he/she does not have to pass full details.
Annex 10 See UK AIP GEN 1.7	In the UK the additional term - FREECALL shall have the meaning “CALL (unit) (your details have not been passed)” .	This informs the pilot he/she will have to pass full details to the next ATS unit/frequency on first contact.
Annex 10 See UK AIP GEN 1.7	PAN PAN MEDICAL is not used in the UK but refers to a Geneva Convention term associated with medical transportation by parties involved in a conflict.	Use of this term is not appropriate in the UK.

Source/Additional Information	Details of ICAO/UK Difference	Reason/Remarks
ANNEX 10 and PANS-ATM See UK AIP GEN 1.7	RECLEARED (ICAO) is only used in the UK for route clearances and not for vertical clearances.	The direction of vertical movement, provided by CLIMB and DESCEND , acts as a check in some circumstances when a pilot misinterprets a call not directed at him/her.
Annex 10 See UK AIP GEN 1.7	The following method of acknowledging receipt is not used in the UK. 'The callsign of the aircraft followed if necessary by callsign of the aeronautical station' (ICAO). (CALLSIGN) ROGER is used in the UK.	The UK procedure is in accordance with the examples in ICAO Doc 9432 (1990) Manual of Radiotelephony, which are different to those described in ICAO Annex 10 Aeronautical Telecommunications.
PANS-ATM See UK AIP GEN 1.7	Phraseology ' CLEARED FOR ILS APPROACH ' is used in the UK only for self-positioned approaches. For radar-positioned ILS approaches in the UK, pilots will be instructed: ' When established on the localiser, descend on the glidepath... '	Due to procedure design and airspace complexity, along with lessons learned from flight safety related incidents and occurrences, the UK has elected to enhance safety by adopting unambiguous phraseology that includes a positive descent instruction to ensure that descent is initiated only when it is safe to do so.
PANS-ATM See UK AIP GEN 1.7	RVSM Phraseology In the UK, pilots are not required to report nonapproved (RVSM) status in all requests for level changes and in all read-backs of level changes (ICAO).	This procedure is considered too cumbersome and not required as the controller has a mechanism for the status of the aircraft to be reflected.
Annex 10 See UK AIP GEN 1.7	NEGATIVE I SAY AGAIN (ICAO) is not used in the UK. In the UK, if a readback is incorrect, the aeronautical station shall transmit the word NEGATIVE followed by the correct version.	The phrase I SAY AGAIN is considered superfluous in this case.
PANS-ATM See UK AIP GEN 1.7 and 3.3.3	The ICAO phraseology for conditional line-up clearance BIGJET 347, BEHIND THE DC9 ON SHORT FINAL, LINE UP BEHIND (ICAO) is not used. In the UK the phrase BIGJET 347 AFTER THE LANDING DC9 LINE UP is used.	AFTER is used instead of BEHIND to describe more clearly 'sequential following' rather than 'further back'. The reiteration of the condition at the end of the phrase is considered to reduce the clarity of the instruction.
PANS-ATM See UK AIP GEN 1.7	In the UK an additional phrase, LAND AFTER THE (Aircraft Type) is used.	This phrase may be used under certain conditions and indicates that a preceding aircraft is not clear of the runway.

Source/Additional Information	Details of ICAO/UK Difference	Reason/Remarks
CAP 413 Chapter 4 Note: phraseology used by Flight Information Service Officers at aerodromes and by controllers in relation to specified helicopter manoeuvres	In the UK, additional phrases, LAND AT YOUR DISCRETION and TAKE-OFF AT YOUR DISCRETION are used.	These phrases may be used under certain conditions and indicate that a landing clearance or a take-off clearance cannot be issued and any landing or take-off is to be conducted at the pilot's discretion.
Annex 10 See UK AIP GEN 1.7	The following method of ending conversations is not used in the UK. 'A radiotelephone conversation shall be terminated by the receiving station using its own callsign' (ICAO). In the UK the word OUT is used to indicate that the transmission has ended and no response is expected.	When there little possibility of confusion or misunderstanding, the word OUT is normally omitted.
Annex 10 See UK AIP GEN 1.7	Radiotelephony Reply Procedure In the UK under certain circumstances the answering ground station may omit its callsign.	Omitting the ground station callsign may reduce RTF congestion and therefore improve safety standards at busy ATC units.
See UK AIP Gen 1.7	Helicopter Phraseology Additional radiotelephony terms for helicopter operations are defined for use in the UK.	To reduce the possibility of misunderstanding, several additional terms pertaining to rotarywing operations are defined for use in the UK.
Annex 10 See UK AIP GEN 1.7	Listening Watch on 121.5 MHz ICAO requirements for Aeronautical Station Listening Watch on VHF emergency channel 121.5 MHz are not applied in the UK.	VHF emergency channel frequency 121.5 MHz is not routinely monitored at civil aerodromes, however, it is monitored H24 at Area Control Centres with coverage over most of the UK above 3000 ft amsl.
PANS-ATM See UK AIP GEN 1.7	Atmospheric Pressure The term HECTOPASCAL is not used in the UK.	When describing atmospheric pressure, the term MILLIBAR (mb) is used in the UK in place of HECTOPASCAL (hPa). (One Millibar being equal to one Hectopascal).
PANS-ATM See UK AIP GEN 1.7	When describing levels, FLIGHT LEVEL or FEET shall be used.	

Source/Additional Information	Details of ICAO/UK Difference	Reason/Remarks
PANS ATM See UK AIP GEN 1.7	For level changes and reports, TO shall only be used in connection with altitude or height, e.g. DESCEND TO ALTITUDE 3000 FEET . It is not used when describing Flight Levels, e.g. CLIMB FLIGHT LEVEL 250 .	TO is not used in connection with Flight Levels, in order to reduce the possibility of misunderstanding in circumstances where the Flight Level includes the figure two, e.g. FLIGHT LEVEL 220 .
PANS-ATM See UK AIP GEN 1.7	' CRUISE CLIMB ' is not used in the UK.	
PANS-ATM See UK AIP GEN 1.7	Avoiding Action For avoiding action the following phraseology will be used: AVOIDING ACTION, TURN LEFT (OR RIGHT) IMMEDIATELY HEADING (three digits). TRAFFIC (bearing by clock reference and distance).	
See UK AIP GEN 1.7	Student Pilots In the UK, pilots may hear the term 'STUDENT' as part of the RTF callsign.	The use of this term has been introduced to alert controllers and other airspace users to the presence of student pilots flying solo.
See UK AIP GEN 1.7 and 3.3.3	Reduced Runway Separations When using ICAO reduced runway separation procedures, the phraseology LAND AFTER THE (aircraft type) will be used. Full details of these procedures are notified in GEN 3.3.3.	
See UK AIP GEN 1.7	Unlawful Interference Pilots of aircraft subject to unlawful interference may hear one or more of the following phraseologies: I AM INSTRUCTED BY HER MAJESTY'S GOVERNMENT TO REFUSE ENTRY INTO UNITED KINGDOM AIRSPACE/TO INFORM YOU THAT LANDING CLEARANCE HAS BEEN REFUSED FOR ANY AERODROME WITHIN THE UNITED KINGDOM. WHAT ARE YOUR INTENTIONS? I AM INSTRUCTED BY HER MAJESTY'S GOVERNMENT THAT YOU ARE TO HOLD AT (fix or GPS position) AT (level). ACKNOWLEDGE.	

Source/Additional Information	Details of ICAO/UK Difference	Reason/Remarks
See UK AIP GEN 1.7	Approach Delays If, for reasons other than weather, e.g. an obstruction on the runway, the extent of approach delays is not known, aircraft will be advised DELAY NOT DETERMINED . As soon as it is possible for aircraft to recommence approach procedures, EATS will be issued.	
See UK AIP GEN 1.7 AIC 1000/2006 (Pink 103)	Approaching to land below the Specified Minimum for Landing The UK has specific legislation regarding aerodrome operating minima (see Air Navigation Order 2005 as amended). Procedures have been published to notify pilots of the actions and phraseologies used by controllers when a breach of the legislation is suspected.	

INTENTIONALLY LEFT BLANK

Appendix 2 UK Civil/Military Radiotelephony Differences

- 1 For operational reasons there are a number of areas where UK military phraseology differs from UK civil phraseology.
- 2 Chapter 10 of this Manual details Military Specific Phraseology for specific use by military ATCOs and military aircrew. The RTF described in Chapter 10 is complementary to NATO STANAG 3817. It is also complementary to the remainder of CAP 413, as it either differs from civil phraseology or there is no equivalent civil phraseology, e.g. in the case of arrestor system procedures.
- 3 Although the RTF described in Chapter 10 is designed for use by military ATCOs and aircrew, civil pilots visiting military aerodromes will be expected to be aware of the military phraseology shown in Chapter 10 and comply with such instructions as may be issued by military controllers. Where relevant, cross references from the remainder of CAP 413 to the equivalent military phraseology are provided for the assistance of civil pilots visiting military aerodromes.
- 4 Significant differences between UK civil and UK military phraseology are described in the table below.

Details of Civil/Military Phraseology Difference	Civil Phraseology Reference	Military Phraseology Reference
<p>Transmission of Frequencies</p> <p>Civil usage is to transmit all 6 figures of a frequency, except where the final 2 digits are zero, in which case only the first 4 digits need be given.</p> <p>For UHF channels military usage differs in that only the first five digits are pronounced.</p>	Chapter 2, page 4 paragraph 1.4.4	Chapter 10, page 1, paragraph 2.1
<p>Transmission of Time</p> <p>Civil usage is that when transmitting time, only the minutes of the hours are normally required. However the hours should be included if there is any possibility of confusion.</p> <p>When aircraft check the time with the appropriate military ATSU, time checks shall be given to the nearest half-minute, or to the second on request.</p>	Chapter 2, page 4, paragraph 1.5.1	Chapter 10, page 1, paragraph 2.2
<p>Standard Words and Phrases</p> <p>A small number of additional or amended standard words and phrases are used by military pilots and controllers.</p>	Chapter 2, page 5, paragraph 1.6	Chapter 10, page 1, paragraph 2.3
<p>SSR Phraseology</p> <p>Civil phraseology is 'squawk Mayday'.</p> <p>Military phraseology is 'squawk emergency' or 'squawk 7700'.</p>	Chapter 5, page 2, paragraph 1.3.1	Chapter 10, page 2, paragraph 2.5

Details of Civil/Military Phraseology Difference	Civil Phraseology Reference	Military Phraseology Reference
NATO Studs and Common VHF Frequencies	Not used	Chapter 10, page 2, paragraph 3.2
Weather and Aerodrome Information	Chapter 4, page 42 paragraph 7	Chapter 10, page 3, paragraph 3.3
<p>Cancellation of Take-Off</p> <p>When an aircraft is about to take-off or has commenced the take-off run, and it is necessary that the aircraft should abandon take-off, a civil controller will instruct the aircraft to cancel take-off or stop immediately.</p> <p>If a military controller is aware of a potential hazard to an aircraft about to start its take-off run, the controller will instruct or signal the aircraft to hold. If the aircraft has already started its take-off run, the controller will inform the aircraft of the hazard. It is then the aircraft captain's responsibility to decide the best course of action.</p>	Chapter 4, page 9, paragraph 1.7.13	Chapter 10, page 4, paragraph 3.4
Phraseology for Joining the Visual Circuit/Pattern via the Initial Point	Not used	Chapter 10, page 4, paragraph 3.5
<p>Visual Circuit Phraseology</p> <p>If intending to land it is not necessary for a civil pilot to include intentions in the downwind report.</p> <p>Military pilots will state their intentions as part of the downwind report.</p>	Chapter 4, page 11, paragraph 1.8.5 ff	Chapter 11, page 25, paragraph 1.4
<p>Landing Gear Position</p> <p>At civil aerodromes it is not normal practice for pilots to report the gear position as part of the 'final' report.</p> <p>At military aerodromes pilots of aircraft with retractable landing gear will report the gear position as part of the request for an ATC clearance to use the runway.</p>	Chapter 4, page 14, paragraph 1.9.6	Chapter 10, page 5, paragraph 3.6
Phraseology for Arrestor Gear Positions and Engagements	Not used	Chapter 10, page 5, paragraph 3.7
Phraseology for Vertical Take-Off and Landing (VTOL) Operations	Not used	Chapter 10, page 8, paragraph 3.8
Flameout/Engine Failure – Aerodrome Phraseology	Not used	Chapter 10, page 8, paragraph 3.10
Phraseology for Precision Approach Radar (PAR)	Not used	Chapter 10, page 9, paragraph 3.11

Details of Civil/Military Phraseology Difference	Civil Phraseology Reference	Military Phraseology Reference
<p>PAR Azimuth Only/Surveillance Radar Approach (SRA) Phraseology</p> <p>There are a number of significant differences between civil and military SRA phraseology.</p>	Chapter 6, page 21, paragraph 1.11	Chapter 10, page 11, paragraph 3.12
<p>ILS Phraseology</p> <p>There are a number of significant differences between civil and military ILS phraseology.</p>	Chapter 6, page 3 and 9	Chapter 10, page 13, paragraph 3.13
<p>Descent to Low Level</p>	Not used	Chapter 10, page 14, paragraph 3.14
<p>Jamming Phraseology</p>	Not used	Chapter 10, page 14, paragraph 3.15
<p>Speechless Procedures</p>	Not used	Chapter 10, page 14, paragraph 3.16
<p>Missed Approach</p> <p>Military phraseology for instructing an aircraft to carry out a missed approach differs from civil phraseology.</p>	Chapter 4, page 15, paragraph 1.10	Chapter 10, page 16, paragraph 3.17
<p>Suspension of RT Procedures</p>	Not used	Chapter 10, page 17, paragraph 3.18
<p>Trail Approaches</p>	Not used	Chapter 10, page 17, paragraph 3.19
<p>Contact Lost</p>	Not used	Chapter 10, page 17, paragraph 3.20
<p>Phraseology 'Freecall' and 'Continue with'</p> <p>'Continue with' is not used by civil controllers, whilst 'Freecall' is mainly used by military controllers</p>	Chapter 2, page 5 paragraph 1.6	Chapter 10, page 17, paragraph 3.21
<p>Aerobatics and General Handling</p>	Not used	Chapter 10, page 18, paragraph 3.22
<p>Persons on Board (POB)</p> <p>In civil usage POB may be added to a taxi request, e.g. where a flight plans is not required and has not been filed.</p> <p>Military pilots should transmit POB in accordance with local or national orders.</p>	Chapter 4 page 2 paragraph 1.5.1	Chapter 10, page 18, paragraph 3.23
<p>Clearances with an Occupied Runway</p>	Chapter 4 page 14 paragraph 1.9.4	Chapter 10, page 18, paragraph 3.24
<p>Formation Landing Clearances</p>	Not used	Chapter 10, page 19, paragraph 3.25
<p>TACAN Specific Phraseology</p>	Not used	Chapter 10, page 19, paragraph 3.26

Details of Civil/Military Phraseology Difference	Civil Phraseology Reference	Military Phraseology Reference
Radar Practice Forced Landing (PFL)	Not used	Chapter 10, page 20, paragraph 3.27
Controlled Descent through Cloud (QGH)	Not used Note: A QGH differs from the VDF procedure shown in Chapter 6 paragraph 1.8, which is totally pilot interpreted.	Chapter 10, page 20, paragraph 3.28
Flameout Spiral Descent	Not used	Chapter 10, page 23, paragraph 3.29
No Compass no Gyro Phraseology	Not used	Chapter 10, page 25, paragraph 3.30
Supersonic Flight	Not used	Chapter 10, page 25, paragraph 3.31
MATZ Crossing	Not used	Chapter 10, page 26, paragraph 3.32
Emergency Message Emergency messages by military pilots are different from civil usage.	Chapter 8, page 3, paragraph 1.5	Chapter 10, page 8, paragraph 3.9 (JSP 552 Section 700)

Bibliography

ICAO Annex 10 Volume 2 Communication Procedures

ICAO Document No. 4444 Procedures for Air Navigation Services - Air Traffic Management (PANS-ATM)

ICAO Document No. 8400 Procedures for Air Navigation Services – ICAO Abbreviations and Codes (PANS-ABC)

ICAO Document No. 9432 Manual of Radiotelephony

CAP 32 UK Aeronautical Information Publication (AIP) (*All 'ENR' references are contained herein.*)

CAP 493 Manual of Air Traffic Services (MATS Part 1)

CAP 410 Manual of Flight Information Services (*Consists of two volumes, Part A and Part B*)

CAP 452 Aeronautical Radio Station Operator's Guide

CAP 774 UK Flight Information Services (effective 12 March 2009)

NATO Standing Agreements (STANAG) 3817 Standard R/T Phraseology to be used for Air Traffic Control

JSP 552 Military Air Traffic Service Regulations

All CAA Publications are available from the CAA website at www.caa.co.uk/publications.

INTENTIONALLY LEFT BLANK

Index

Military specific items are marked with '(M)'.

Numerics

8.33 kHz Phraseology Chapter 9, Page 4

A

Abandon take-off	Chapter 4, Page 9
Abbreviations	Chapter 1, Page 5
ACAS/TCAS Phraseology	Chapter 5, Page 7
Acknowledgement of Receipt	Chapter 2, Page 13
Aerobatics and General Handling (M)	Chapter 10, Page 18
Aerodrome Air/Ground Communication Service	Chapter 2, Page 7
Aerodrome Control Service	Chapter 1, Page 1
Aerodrome Emergency Services	Chapter 9, Page 7
Aerodrome Flight Information Service (AFIS)	Chapter 1, Page 1
Aerodrome Traffic Circuit	Chapter 4, Page 10
Aerodrome Traffic Zone	Chapter 1, Page 1, Chapter 4, Page 18
Aerodrome Traffic Zone (ATZ) associated with another Aerodrome	Chapter 6, Page 25
Aeronautical stations	Chapter 2, Page 7
Air traffic control service	Chapter 2, Page 7
Air Traffic Services Outside Controlled Airspace (ATSOCAS)	Chapter 6, Page 26
Air/Ground Station Identification	Chapter 4, Page 32
Airborne Collision Avoidance System	Chapter 1, Page 1
Aircraft Operating Agency Messages	Chapter 9, Page 3
Aircraft radio faults	Chapter 2, Page 21
AIRPROX	Chapter 1, Page 2, Chapter 1, Page 6, Chapter 9, Page 2
Airway	Chapter 1, Page 2
Altitude	Chapter 1, Page 2
Approach Control Service Phraseology	Chapter 6, Page 1
Approach control unit	Chapter 6, Page 3, Chapter 6, Page 7
Area Control Service Phraseology	Chapter 7, Page 1
Area Navigation Global Navigation Satellite System RNAV (GNSS)	Chapter 6, Page 20

Arrestor System Procedures and Phraseology (M)	Chapter 10, Page 5
ATC instructions	Chapter 3, Page 4
ATC route clearance	Chapter 2, Page 14, Chapter 6, Page 2
ATIS	Chapter 1, Page 6, Chapter 4, Page 1, Chapter 4, Page 5, Chapter 4, Page 10, Chapter 4, Page 46, Chapter 6, Page 7
ATS surveillance service	Chapter 5, Page 1, Chapter 5, Page 4
ATZ	Chapter 1, Page 6, Chapter 4, Page 1, Chapter 4, Page 18, Chapter 4, Page 32
Avoiding Action Phraseology	Chapter 5, Page 6
B	
Broken Down Vehicle	Chapter 4, Page 31
C	
Callsign Prefix - STUDENT	Chapter 2, Page 9
Callsigns for Aeronautical Stations	Chapter 2, Page 7
Callsigns for Aircraft	Chapter 2, Page 8
Cancel an IFR flight plan	Chapter 3, Page 10
Cancellation of Landing Clearance	Chapter 4, Page 14
Cancellation of Take-Off	Chapter 4, Page 9
Cancellation of Take-Off (M)	Chapter 10, Page 4
Categories of Message	Chapter 2, Page 22
Clearance Issue	Chapter 2, Page 14
Clearance limit	Chapter 1, Page 2, Chapter 4, Page 2, Chapter 6, Page 8
Clearance to enter Control Zones (CTR)	Chapter 6, Page 24
Clearances with an Occupied Runway (M)	Chapter 10, Page 18
Communication failure	Chapter 2, Page 19
Communications (M)	Chapter 10, Page 2
Communications and Loss of Communications	Chapter 5, Page 8
Conditional clearances	Chapter 4, Page 7
Contact Lost (M)	Chapter 10, Page 17
Continuation of Communications	Chapter 2, Page 11

Continuous listening watch	Chapter 4, Page 27
Controlled airspace	Chapter 1, Page 3, Chapter 6, Page 3, Chapter 7, Page 2
Controlled Descent through Cloud (QGH) (M)	Chapter 10, Page 20
Corrections and Repetitions	Chapter 2, Page 13
CPDLC	Chapter 1, Page 6
CPDLC Failure	Chapter 9, Page 7
Cross a Runway	Chapter 4, Page 29

D

D&D Sections	Chapter 8, Page 1
DAAIS	Chapter 1, Page 6, Chapter 5, Page 10
DACS	Chapter 1, Page 6, Chapter 5, Page 9
Danger Area Activity Information Service (DAAIS)	Chapter 5, Page 10
Danger Area Crossing Service (DACS)	Chapter 5, Page 9, Chapter 11, Page 28
Definitions	Chapter 1, Page 1
Delays	Chapter 3, Page 10
Departure Information and Engine Starting Procedures	Chapter 4, Page 1
Descent clearance	Chapter 6, Page 3
Descent to Low Level (M)	Chapter 10, Page 14
Designated Positions in the Traffic Circuit	Chapter 4, Page 10
Direction Finding (DF)	Chapter 6, Page 12
Distress and Urgency Communication Procedures	Chapter 8, Page 1
Driver unsure of Position	Chapter 4, Page 31

E

Ejection from Aircraft	Chapter 8, Page 4
Emergency Descent	Chapter 8, Page 6
Emergency Message	Chapter 8, Page 3
Emergency Messages (M)	Chapter 10, Page 8
Emergency Service	Chapter 8, Page 1
Essential Aerodrome Information	Chapter 4, Page 16
Essential Traffic Information	Chapter 5, Page 8

F

Final Approach and Landing	Chapter 4, Page 13
----------------------------	--------------------

Flameout Spiral Descent (M)	Chapter 10, Page 23
Flameout/Engine Failure – Aerodrome Phraseology (M)	Chapter 10, Page 8
Flight Information Service Officer (FISO)	Chapter 4, Page 18
Flight Plans	Chapter 3, Page 9
Flight Receiving Avoiding Action	Chapter 11, Page 31
Flight Receiving En-Route Basic Service	Chapter 11, Page 32
Flights Crossing Airways	Chapter 7, Page 3
Flights Holding En-Route	Chapter 7, Page 3
Flights Joining Airways	Chapter 7, Page 2
Flights Leaving Airways	Chapter 7, Page 2
Formation Clearances (M)	Chapter 10, Page 19
Formations in Trail (M)	Chapter 10, Page 17
Freecall and Continue With (M)	Chapter 10, Page 17

G

Glidepath	Chapter 6, Page 9
-----------	-------------------

H

Helicopter Callsigns	Chapter 4, Page 23
Helicopter Phraseology	Chapter 4, Page 23
Hold en-route	Chapter 7, Page 3
Holding pattern	Chapter 6, Page 17
Holding point	Chapter 1, Page 3, Chapter 4, Page 2, Chapter 4, Page 6
Hours of Service and Communications Watch	Chapter 2, Page 21

I

IFR Arrivals	Chapter 6, Page 3
IFR Departures	Chapter 6, Page 1
ILS	Chapter 1, Page 8, Chapter 6, Page 9
ILS Phraseology (M)	Chapter 10, Page 12
Imposition of Silence	Chapter 8, Page 5
Initial Call – IFR	Chapter 3, Page 6
Initial Call – VFR	Chapter 3, Page 7
Instrument approach procedures	Chapter 6, Page 17
Instrument Departures	Chapter 6, Page 1
Interceptions by Military Aircraft	Chapter 9, Page 3

J	
Jamming phraseology (M)	Chapter 10, Page 14

L	
Landing Altimeter Setting (QNE)	Chapter 6, Page 24
Landing Gear Position (M)	Chapter 10, Page 5
Letters	Chapter 2, Page 2
Level Instructions	Chapter 3, Page 1
Listening watch	Chapter 2, Page 21
Localiser	Chapter 6, Page 9
Low Visibility Procedures	Chapter 3, Page 10, Chapter 4, Page 31
Lower Airspace Radar Service (LARS)	Chapter 6, Page 26, Chapter 11, Page 28

M	
Mareva Injunctions	Chapter 9, Page 6
MATZ (M)	Chapter 1, Page 8, Chapter 10, Page 26
MATZ Penetration Service (M)	Chapter 10, Page 26
MAYDAY	Chapter 8, Page 1, Chapter 8, Page 3
Messages regarding Safety of an Aircraft	Chapter 4, Page 31
Messages regarding Wildlife	Chapter 4, Page 31
Meteorological aerodrome reports	Chapter 4, Page 42
Meteorological Conditions	Chapter 4, Page 42
Microwave	Chapter 6, Page 9
Microwave Approach	Chapter 1, Page 4
Military Aircraft Callsigns	Chapter 2, Page 10
Military Missed Approach (M)	Chapter 10, Page 16
Military Safety Broadcast - Sécurité (M)	Chapter 10, Page 27
Military Visual Circuit	Chapter 11, Page 24
Millibars	Chapter 3, Page 2
Missed Approach	Chapter 4, Page 15
Missed Approach Procedure	Chapter 1, Page 4
MLS	Chapter 1, Page 8, Chapter 6, Page 9
Movement Instructions	Chapter 4, Page 27
Movement of vehicles	Chapter 4, Page 27

N

NATO Standard Visual Circuit Procedures (M)	Chapter 10, Page 2, Chapter 11, Page 24
NATO Studs and Common VHF Frequencies (M)	Chapter 10, Page 2
NDB(L) and VOR Procedures	Chapter 6, Page 17
No Compass/No Gyro (M)	Chapter 10, Page 25
Numbers	Chapter 2, Page 3

O

Offshore Communication Service	Chapter 4, Page 36
Offshore Phraseology	Chapter 4, Page 36
Offshore Station Identification	Chapter 4, Page 36
Oil Pollution Reporting	Chapter 9, Page 2
Operations by Aircraft Deploying Brake Chutes	Chapter 9, Page 5

P

PAN PAN	Chapter 8, Page 1, Chapter 8, Page 3
PAR Approach	Chapter 6, Page 24
PAR Azimuth Only/SRA Phraseology (M)	Chapter 10, Page 11
PAR Phraseology (M)	Chapter 10, Page 9
Passing the Number of Persons on Board (POB) (M)	Chapter 10, Page 18
Phraseology for Fixed-Wing VTOL Operations (M)	Chapter 10, Page 8
Phraseology for Joining the Visual Circuit/Pattern (M)	Chapter 10, Page 4
Position Reporting	Chapter 3, Page 8, Chapter 7, Page 1
Practice Pan	Chapter 11, Page 33
Pre-Departure Manoeuvring	Chapter 4, Page 5
Pushback and Powerback	Chapter 4, Page 2

Q

QDM	Chapter 1, Page 9, Chapter 6, Page 12
QDR	Chapter 1, Page 9, Chapter 6, Page 12
QFE	Chapter 1, Page 9, Chapter 4, Page 36, Chapter 6, Page 24, Chapter 11, Page 23
QNE	Chapter 1, Page 9, Chapter 6, Page 24

QNH Chapter 1, Page 9,
Chapter 3, Page 1,
Chapter 4, Page 1,
Chapter 4, Page 5

QTE Chapter 1, Page 9,
Chapter 6, Page 12

R

Radar Identification of Aircraft Chapter 5, Page 1

Radar PFL (M) Chapter 10, Page 20

Radar Vectoring Chapter 5, Page 4

Radio Procedures – Practice Emergencies Chapter 8, Page 4

Read Back Requirements Chapter 2, Page 14

Readability Scale Chapter 2, Page 21

Reduced Traffic Information Chapter 6, Page 28

Reduced Vertical Separation Minimum Chapter 7, Page 4

Relayed Emergency Message Chapter 8, Page 5

RT Phraseology When Using SSR (M) Chapter 10, Page 2

Runway Surface Conditions Chapter 4, Page 45

Runway Vacating and Communicating After Landing Chapter 4, Page 16

Runway Visual Range Chapter 1, Page 4

Runway Visual Range (RVR)/Visibility/Absolute Minimum Chapter 4, Page 43

RVR Chapter 1, Page 9,
Chapter 4, Page 43

RVSM Chapter 7, Page 4

S

SAFETYCOM Chapter 1, Page 4,
Chapter 4, Page 39

Safetycom Chapter 4, Page 39

Secondary Surveillance Radar Phraseology Chapter 5, Page 2

Securité (M) Chapter 10, Page 27

Simultaneous Transmissions Chapter 2, Page 18

Special Purpose Codes Chapter 8, Page 2

Special VFR Chapter 1, Page 4,
Chapter 6, Page 2,
Chapter 6, Page 8

Special VFR clearances Chapter 6, Page 8

Speechless Code Chapter 8, Page 4

Speechless Procedures (M) Chapter 10, Page 14

Speed Control	Chapter 3, Page 5
SRA	Chapter 1, Page 9, Chapter 6, Page 21, Chapter 6, Page 22
SSR	Chapter 1, Page 9
Standard Overhead Join	Chapter 4, Page 10, Chapter 4, Page 39, Chapter 4, Page 41
Standard Words and Phrases	Chapter 2, Page 5
Standard Words and Phrases (M)	Chapter 10, Page 1
States of Emergency	Chapter 8, Page 1
Straight-in approach	Chapter 4, Page 11
STUDENT	Chapter 2, Page 9
Supersonic Flight (M)	Chapter 10, Page 25
Surveillance Radar Approach (SRA)	Chapter 6, Page 21
Suspension of RT Procedures (M)	Chapter 10, Page 17

T

TACAN Specific Phraseology (M)	Chapter 10, Page 19
Take-off	Chapter 2, Page 14, Chapter 4, Page 1, Chapter 4, Page 6
Take-off clearance	Chapter 4, Page 6, Chapter 4, Page 8
Taxi Instructions	Chapter 4, Page 2
TCAS	Chapter 5, Page 7
Terminations of Distress Communications and of RTF Silence	Chapter 8, Page 6
Test procedures	Chapter 2, Page 20
Time	Chapter 2, Page 4
Traffic Alert and Collision Avoidance System (TCAS)	Chapter 1, Page 5
Traffic Information and Avoiding Action Phraseology	Chapter 5, Page 6
Training Fix	Chapter 8, Page 5
Transfer of communications	Chapter 2, Page 13
Transmission of Letters	Chapter 2, Page 2
Transmission of Numbers	Chapter 2, Page 3
Transmission of Time	Chapter 2, Page 4
Transmission of Time (M)	Chapter 10, Page 1
Transmission of UHF Channels (M)	Chapter 10, Page 1
Transmitter failure	Chapter 2, Page 19
Transmitting Blind	Chapter 2, Page 19

U

UHF Emergency Service	Chapter 8, Page 1
Unattended Aerodrome Phraseology	Chapter 4, Page 40
Unattended Aerodromes	Chapter 4, Page 39
Use of ATS Frequencies for Aircraft Operating Agency Messages	Chapter 9, Page 4

V

VDF Procedure	Chapter 6, Page 13
Vectoring to Final Approach	Chapter 6, Page 9
Vehicle Radio Failure	Chapter 4, Page 31
Vehicles Towing Aircraft	Chapter 4, Page 30
VFR Arrivals	Chapter 6, Page 7
VFR Departures	Chapter 6, Page 2
VHF Direction Finding (VDF)	Chapter 6, Page 12
VHF Emergency Service	Chapter 8, Page 1
Voice Weather Broadcast (VOLMET) UK	Chapter 4, Page 42

W

Wake Turbulence	Chapter 9, Page 1
Wake turbulence category	Chapter 2, Page 9
Weather and Aerodrome Information (M)	Chapter 10, Page 3
Wind Shear	Chapter 9, Page 1
Withholding Clearances	Chapter 2, Page 17

INTENTIONALLY LEFT BLANK